







# Company Introduction



# GRAND<sup>®</sup> DEVICES

*The Grand Instruments Company*

From a humble start in 1999, we have grown large and strong over the decades to the extent that now Grand Devices is confidently prepared to face market challenges and is ready to serve around the globe.

Today, with our highly skilled & professional workforce, we are looking forward to elevating our business to a level where we are even more proud and spirited to sustain our position as the industry leader and prove to be the best partner for our global customer. As we are already producing high quality surgical, veterinary, dental, beauty instruments, and tools for the world's prominent brands. Grand Devices vision for the future revolves around becoming a one-stop solution for customers seeking high quality and commitment in all kind of surgery instruments and jewelry & watches tools.

Thank you for choosing GRAND Products!





## FORGING

Forging is completed keeping in mind the geometry of the process. At this starting point, proper care is taken about your design and made the same as required.

## MILLING

Milling is a process of cutting, shaping and finishing of an instrument. It is the process that includes turning, welding and forging. we use the highest standard milling technology which involves the cutting of pieces of metal to create dovetails, threads, bevels, slots, and ridges.

## GRINDING

To give a final shape to the instrument our specialised craftsman use filling and grinding which removes the material from the instrument by abrasion. Then the instrument is intensely observed and then set to perform perfectly.

## HEAT TREATMENT

At this stage, each instrument passed through heat treatment which determines a considerable extent to the operating characteristics of the instruments. Heat treatment after grinding or sharpening is used to realise stress produced by grinding to prevent the development of grinding cracks and stabilise the structure.

## HEARDNESS TEST

The term hardness refers to the resistance to bending, scratching, abrasion or cutting. At Empire hardness test is applied on all the instruments to measure its resistance to deformation. Keeping the application of instruments in view, this process is highly ranked in the process of our manufacturing.

## ETCHING

We use permanent and life time high quality laser etching which produces a wide variety of text and graphic images-including our customer's logo, with very detailed and fine quality image.

## ULTRASONIC CLEANING

It is recognized risk to surgical instruments of exposure to unidentified microorganisms during the manufacturing process. To minimize the amount and degree of this risk and provide surgical instruments that are clean: safe to handle, safe for patient care are cleaned using the ultrasonic cleaning plants.

## FINAL FINISHING

At this stage, the instrument is given final finish which includes: mirror, satin or matt finish. The finish is as per the customers' requirement.



## Our Manufacturing Process





# GRAND<sup>®</sup> DEVICES index

Table of Contents  
Inhaltsübersicht  
Table des Matières  
Tabla del contenido  
Indice delle sezioni  
目录



## GD 06-07

Thumb and Tissue Forceps  
Pinzetten  
Pincès à dissection  
Pinzas de disección  
Pinze per dissezione  
拇指和组织钳

## GD 10

Atraumatic Forceps  
Atraumatische Klemmen  
Pincès atraumatique  
Pinzas atraumático  
Pinze atraumatico  
无创钳

## GD 13

Trocars, Puncture Needles  
Trocare, Punktionsnadeln  
Trocarts, Aiguilles à ponction  
Trócares, Aguja para puncción  
Trequarti, Aghi da punzione  
套管针, 穿刺针

## GD 16

Towel Clamps  
Tuchklemmen  
Pincès à champs  
Pinzas para campos  
Pinze Fissateli  
杀菌剂

## GD 14

Needle Holders  
Nadelhalter  
Porte-aiguilles  
Porta-agujas  
Port'aghi  
持针器

## GD 17

Suture  
Naht  
Suture  
Sutura  
Sutura  
缝线

## GD 03

Scissors  
Scheren  
Ciseaux  
Tijeras  
Forbici  
剪刀

## GD 08

Polypus and Dressing Forceps  
Tupfer-Kornzangen  
Pincès à pansements et à polypes  
Pinzas para pólipos y esponjas  
Pinze per polipi e per tamponi  
息肉和敷料钳

## GD 11

Scalpels, Knives  
Skalpelle, Messer  
Bistouris, Couteaux  
Bisturías, Cuchillos  
Bisturi, Coltelli  
手术刀和刀

## GD 18

Retractors  
Wundhaken  
Ecarteurs  
Separadores  
Divaricatori  
牵开器

## GD 01

Diagnostics  
Diagnostik  
Diagnostic  
Diagnóstico  
Diagnostica  
诊断程序

## GD 04

Micro Scissors  
Mikro Scheren  
Micro Ciseaux  
Micro Tijeras  
Micro Forbici  
微型剪刀

## GD 02

Scissors  
Scheren  
Ciseaux  
Tijeras  
Forbici  
剪刀

## GD 05

Suction Tubes  
Sauger  
Tubes d'aspiration  
Tubos de aspiración  
Tubi d'aspirazione  
吸管

## GD 09

Hemostatic Forceps  
Arterienklemmen  
Pincès hémostatiques  
Pinzas hemostáticas  
Pinze emostatiche  
止血钳

## GD 12

Probes, Spatulas, Applicators  
Sonden, Spatel, Watteträger  
Sondes, Spatules, porte-coton  
Sondas, Espátulas, porta-algodón  
Sonde, Spatole, portacotone  
探针, 铲子, 涂药器

## GD 15

Sterilizing Aids  
Sterilisierhilfen  
Instrumente pour Sterilisation  
Auxilios para la esterilización  
Utensili per las sterilizzazione  
杀菌剂

## GD 19-20

Bone Surgery, Osteosynthesis  
Orthopädie, Osteosynthese  
Chirurgie osseuse, Ostéosynthèse  
Cirugía ósea, Osteosíntesis  
Chirurgia ossea, Osteosintesi  
骨外科, 骨合成



## GD 21-22

Ophthalmology  
Ophthalmologie  
Ophtalmologie  
Ofthalmología  
Ofthalmologia  
眼科

## GD 23

Otology  
Otologie  
Otologie  
Otología  
Otologia  
耳科

## GD 24

Mouth and Tongue  
Mund und Zunge  
Bouche et langue  
Boca y lengua  
Bocca e lingua  
口舌

## GD 25

Rhinology  
Rhinologie  
Rhinologie  
Rinología  
Rinologia  
鼻科

## GD 26

Intestines and Stomach  
Darm, Magen  
Intestin, Estomac  
Intestines, Estómago  
Intestini, Stomaco  
肠胃

## GD 27

Gall Bladder, Kidney  
Galle, Niere  
Vesicule biliaire, Rein  
Vesicula biliar, Riñón  
Vesicola biliare, Rene  
胆囊和肾脏

## GD 28

Urology  
Urologie  
Urologie  
Urología  
Urologia  
泌尿科

## GD 29

Rectum  
Mastdarm  
Rectum  
Recto  
Retto  
直肠

## GD 30

Tonsils  
Tonsillen  
Amygdales  
Amígdalas  
Tonsille  
扁桃体

## GD 31

Larynx  
Kehlkopf  
Larynx  
Laringe  
Laringe  
喉

## GD 32

Tracheostomy, Goitre  
Tracheotomie, Kropf  
Trachéotomie, Goitre  
Traqueotomía, Bocio  
Tracheotomia, Gozzo  
气管切开术, 甲状腺肿

## GD 33

Plaster of Paris  
Gipsverband  
Bandages plâtrés  
Vendajes enyesados  
Bendaggi gessati  
巴黎的石膏

## GD 34

Gynecology  
Gynäkologie  
Gynécologie  
Ginecología  
Ginecologia  
妇科

## GD 35

High Frequency Surgery  
Hochfrequenz-Chirurgie  
Chirurgie à haute fréquence  
Electrocirugía  
Elettrochirurgia  
高频手术

## GD 36

Obstetrics  
Geburtshilfe  
Obstétrique  
Obstetricia  
Ostetricia  
产科

## GD 37

Dermatology, Hygiene  
Dermatologie, Hygiene  
Dermatologie, Hygiène  
Dermatología, Higiene  
Dermatologia, Igiene  
皮肤卫生

## GD 38

Different Containers  
Verschiedene Behälter  
Boîtes diverses  
Contenedores varios  
vassoi diversi  
不同的容器

# Symbols

Explanation of Symbols

Straight Instrument  
Gerades Instrument  
Instrument droit  
Instrumento recto  
Strumento retto  
直仪



Curved Instrument  
Gebogenes Instrument  
Instrument courbe  
Instrumento curvo  
Strumento curvo  
弯曲仪器



Sharp Instrument  
Scharfes Instrument  
Instrument pointu  
Instrumento agudo  
Strumento acuto  
夏普仪器



Blunt Instrument  
Stumpfes Instrument  
Instrument mousse  
Instrumento romo  
Strumento smusso  
钝器

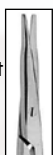

TC Lined  
Mit TC-Einsätzen  
A mors TC  
Con bocas TC  
Con morso TC  
TC衬里

TC Cutting Edges  
Mit TC-Schneiden  
Tanchant TC Filos  
de corte TC  
Taglio TC  
TC尖端

Instrument from Titanium  
Instrument aus Titan  
Instrument en Titane  
Instrumento de Titanio  
Strumento in Titanio  
钛仪器









Diagnostics  
Diagnostik  
Diagnostic  
Diagnóstico  
Diagnostica  
诊断程序

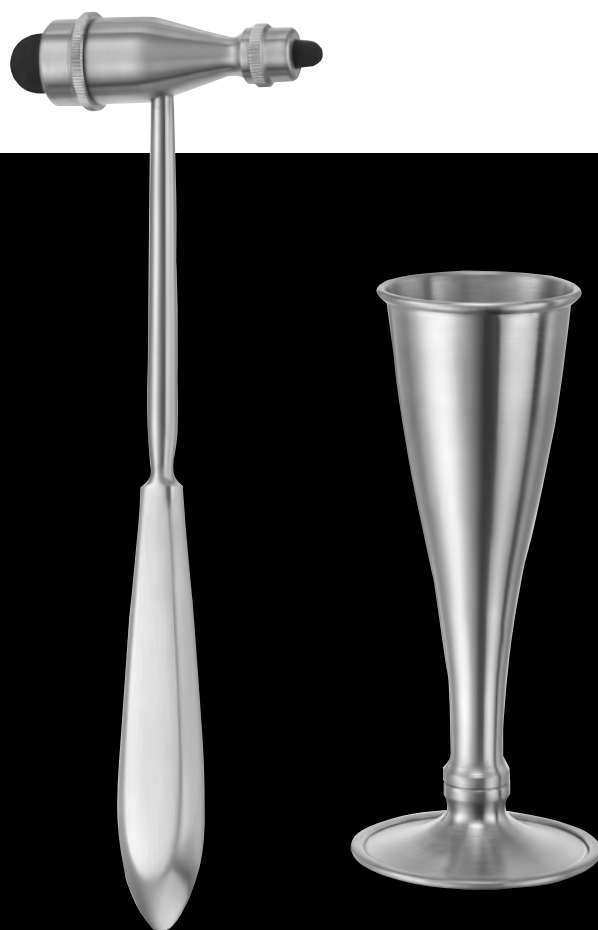

**GD01**





Diagnostics  
Diagnostik  
Diagnostic  
Diagnóstico  
Diagnostica

**GRAND**  
DEVICES  
*The Grand Instruments Company*

**GD01.102.00**

compl.



**GD01.122.00**

compl.



**GD01.132.00**

compl.





**ECONOM**  
**GD01.110.00**  
**GD01.112.00**  
compl.



**GD01.147.00**



**COLLIN**  
**GD01.140.01**  
**GD01.140.02**

Erwachsene - Adult  
Kinder - Child - Enfant  
ninos - bambini



Diagnostics  
Diagnostik  
Diagnostic  
Diagnóstico  
Diagnostica

**GRAND**  
DEVICES  
*The Grand Instruments Company*



**MAY**  
**GD01.162.00**



**GD01.174.00**  
Otoscope - Otokop - Otoscopio



**VARIFOCAL**  
**GD01.160.00**



**GD01.170.00**  
Combination



**GD01.173.00**  
Econom Universal



Head Mirrors, Head Lights  
 Stirnspiegel, Stirnlampen  
 Miroirs, lampes frontales  
 Espejos, lámparas frontales  
 Riflettori, lampade frontali



Head Lights  
 Stirnlampen  
 Lampes frontales  
 Lámparas frontales  
 Lampade frontali



GD01.180.91



ZIEGLER  
 GD01.180.90  
 compl.



CLAR  
 GD01.190.00  
 compl.  
 6 V.



GD01.180.92



GD01.195.00 compl. 6 V.  
 GD01.200.00 compl. Halogen



GD01.190.01



GD01.195.01



GD01.199.06  
 6 V.



Stethoscopes  
Stethoskope  
Stéthoscopes  
Estetoscopios  
Stetoscopi

**GRAND**  
DEVICES  
*The Grand Instruments Company*



**PINARD**  
15.0 cm **GD01.260.15**

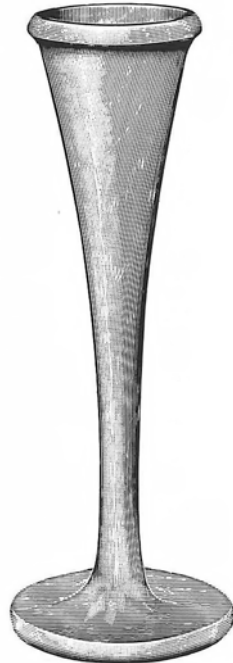

**PINARD**  
18.0 cm **GD01.262.18**



**BOWLES**  
**GD01.2GD01.00**



**DUPLEX**  
**GD01.246.00**



Percussion Hammers  
 Perkussionshämmer  
 Marteaux-percuteurs  
 Martillos de percusión  
 Martelli percussori



**TAYLOR**  
 17.0 cm **GD01.288.17**  
 20.0 cm **GD01.288.20**



**TRAUBE**  
**GD01.290.16**



**BABINSKY**  
 22.0 cm  
**GD01.292.22**



**TROEMNER**  
 24.0 cm  
**GD01.294.24**



**DEJERINE**  
**GD01.302.20**



**DEJERINE**  
**GD01.304.20**



**BERLINER**  
**GD01.306.17**

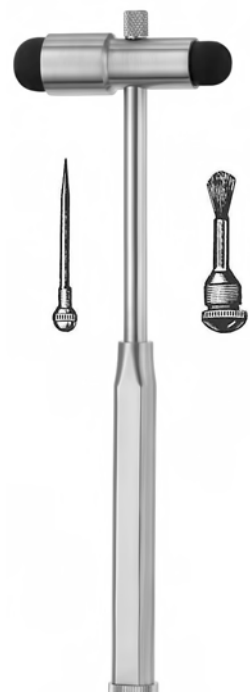

**BUCK**  
**GD01.308.18**



Diagnosics  
Diagnostik  
Diagnostic  
Diagnóstico  
Diagnostica

**GRAND**  
DEVICES  
*The Grand Instruments Company*

Rulers, metal  
Metall Meßstäbe  
Règles en métal  
Reglas de metal  
Regoli in acciaio



10.0 cm	4.0 in	<b>GD01.3GD01.10</b>
20.0 cm	8.0 in	<b>GD01.3GD01.20</b>
30.0 cm	12.0 in	<b>GD01.3GD01.30</b>
50.0 cm	20.0 in	<b>GD01.3GD01.50</b>



**BERTILLON**  
**GD01.310.01**



**MOELTGEN**  
**GD01.312.01**



**WARTENBERG**  
19.0 cm **GD01.320.19**



Scissors  
Scheren  
Ciseaux  
Tijeras  
Forbici  
剪刀



**GD02**



Operating Scissors  
Chirurgische Scheren  
Ciseaux à chirurgie  
Tijeras para cirugía  
Forbici per chirurgia

**GRAND**  
DEVICES  
*The Grand Instruments Company*

TC Cutting Edges  
TC-Schneiden  
Tranchant TC  
Filos de corte TC  
Taglio TC

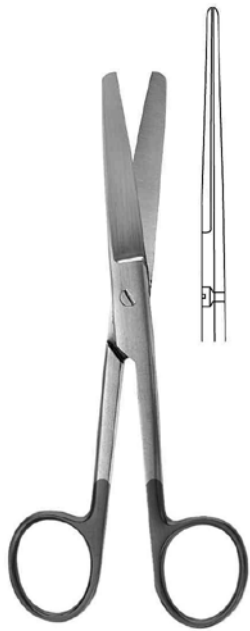

STANDARD

10.5 cm **GD02.102.10**  
11.5 cm **GD02.102.11**  
13.0 cm **GD02.102.13**  
14.5 cm **GD02.102.14**  
15.5 cm **GD02.102.15**  
16.5 cm **GD02.102.16**  
18.5 cm **GD02.102.18**  
20.0 cm **GD02.102.20**

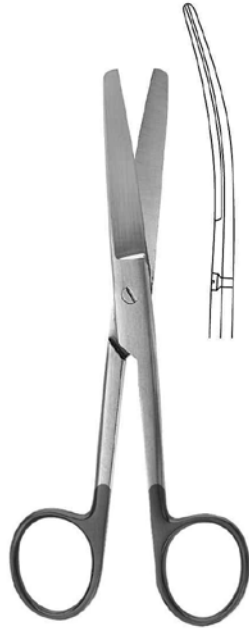

STANDARD

10.5 cm **GD02.103.10**  
11.5 cm **GD02.103.11**  
13.0 cm **GD02.103.13**  
14.5 cm **GD02.103.14**  
15.5 cm **GD02.103.15**  
16.5 cm **GD02.103.16**  
18.5 cm **GD02.103.18**  
20.0 cm **GD02.103.20**



Standard

14.5 cm **GD02.104.14**  
16.5 cm **GD02.104.16**

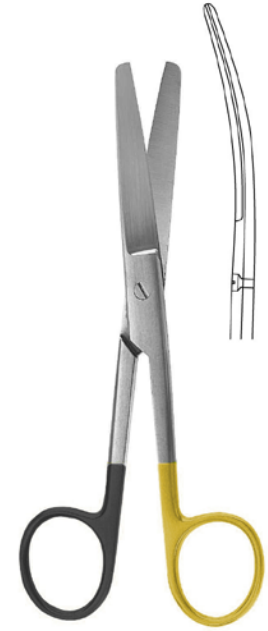

Standard

14.5 cm **GD02.105.14**  
16.5 cm **GD02.105.16**



Operating Scissors  
 Chirurgische Scheren  
 Ciseaux à chirurgie  
 Tijeras para cirugía  
 Forbici per chirurgia



TC Cutting Edges  
 TC-Schneiden  
 Tranchant TC  
 Filos de corte TC  
 Taglio TC

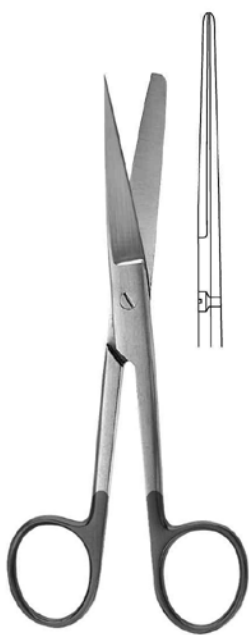

STANDARD

11.5 cm **GD02.110.11**  
 13.0 cm **GD02.110.13**  
 14.5 cm **GD02.110.14**  
 15.5 cm **GD02.110.15**  
 16.5 cm **GD02.110.16**  
 18.5 cm **GD02.110.18**  
 20.0 cm **GD02.110.20**

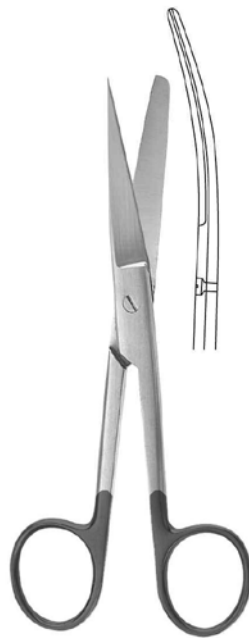

STANDARD

11.5 cm **GD02.111.11**  
 13.0 cm **GD02.111.13**  
 14.5 cm **GD02.111.14**  
 15.5 cm **GD02.111.15**  
 16.5 cm **GD02.111.16**  
 18.5 cm **GD02.111.18**  
 20.0 cm **GD02.111.20**



Standard

14.5 cm **GD02.114.14**  
 16.5 cm **GD02.114.16**

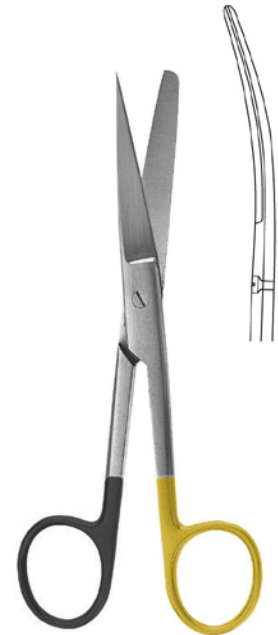

Standard

14.5 cm **GD02.115.14**  
 16.5 cm **GD02.115.16**

L = For left-handed / Für Linkshänder  
 Pour la main gauche / Para zurdo / Per mancini



Operating Scissors  
Chirurgische Scheren  
Ciseaux à chirurgie  
Tijeras para cirugía  
Forbici per chirurgia

**GRAND**  
DEVICES  
*The Grand Instruments Company*

TC Cutting Edges  
TC-Schneiden  
Tranchant TC  
Filos de corte TC  
Taglio TC

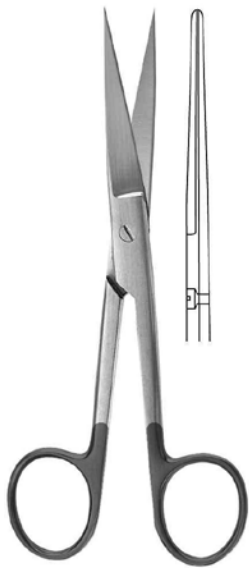

STANDARD

10.5 cm **GD02.120.10**  
11.5 cm **GD02.120.11**  
13.0 cm **GD02.120.13**  
14.5 cm **GD02.120.14**  
15.5 cm **GD02.120.15**  
16.5 cm **GD02.120.16**  
18.5 cm **GD02.120.18**  
20.0 cm **GD02.120.20**

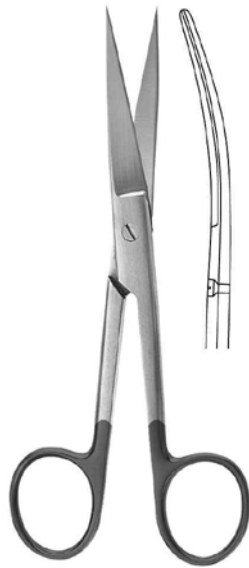

STANDARD

10.5 cm **GD02.121.10**  
11.5 cm **GD02.121.11**  
13.0 cm **GD02.121.13**  
14.5 cm **GD02.121.14**  
15.5 cm **GD02.121.15**  
16.5 cm **GD02.121.16**  
18.5 cm **GD02.121.18**  
20.0 cm **GD02.121.20**



Standard

14.5 cm **GD02.124.14**  
16.5 cm **GD02.124.16**



Standard

14.5 cm **GD02.125.14**  
16.5 cm **GD02.125.16**

Operating Scissors  
 Chirurgische Scheren  
 Ciseaux à chirurgie  
 Tijeras para cirugía  
 Forbici per chirurgia

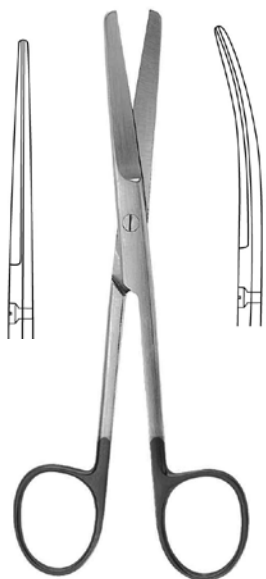

DEAVER

14.0 cm **GD02.130.14**  
**GD02.131.14**

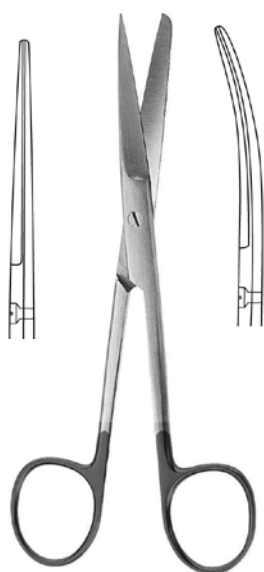

DEAVER

14.0 cm **GD02.140.14**  
**GD02.141.14**

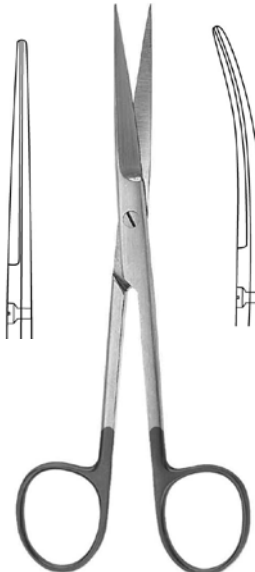

DEAVER

14.0 cm **GD02.150.14**  
**GD02.151.14**

TC Cutting Edges  
 TC-Schneiden  
 Tranchant TC  
 Filos de corte TC  
 Taglio TC

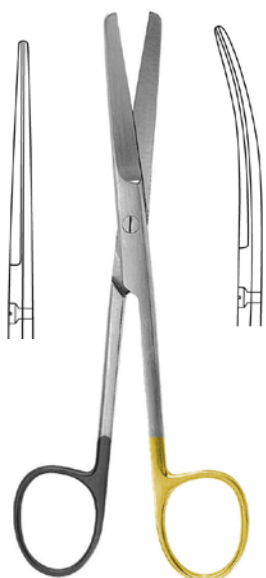

DEAVER

14.0 cm **GD02.134.14**  
**GD02.135.14**

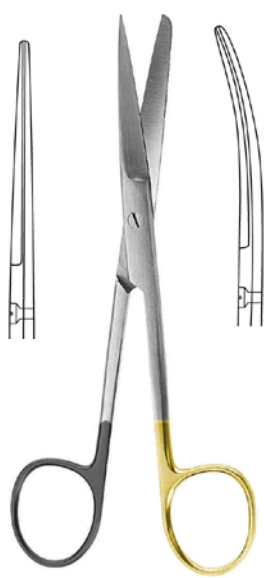

DEAVER

14.0 cm **GD02.144.14**  
**GD02.145.14**

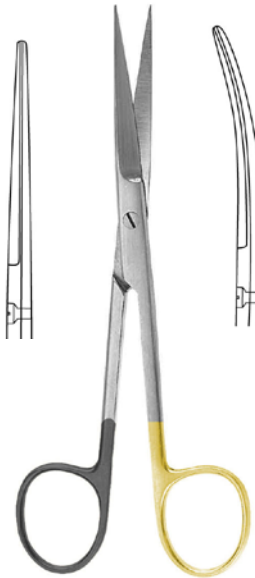

DEAVER

14.0 cm **GD02.154.14**  
**GD02.155.14**





Operating Scissors  
Chirurgische Scheren  
Ciseaux à chirurgie  
Tijeras para cirugía  
Forbici per chirurgia

**GRAND**  
DEVICES  
*The Grand Instruments Company*

TC Cutting Edges  
TC-Schneiden  
Tranchant TC  
Filos de corte TC  
Taglio TC



MAYO

14.5 cm **GD02.160.14**  
17.0 cm **GD02.160.17**  
23.0 cm **GD02.160.23**

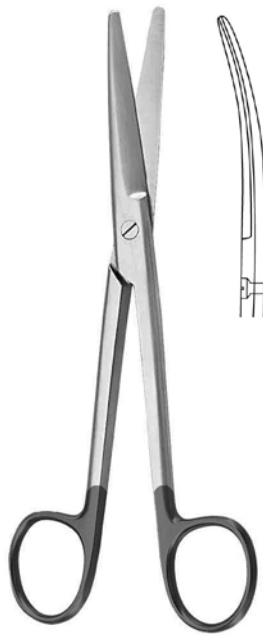

MAYO

14.5 cm **GD02.161.14**  
17.0 cm **GD02.161.17**  
23.0 cm **GD02.161.23**



MAYO

14.5 cm **GD02.164.14**  
17.0 cm **GD02.164.17**  
23.0 cm **GD02.164.23**



MAYO

14.5 cm **GD02.165.14**  
17.0 cm **GD02.165.17**  
23.0 cm **GD02.165.23**

Operating Scissors  
 Chirurgische Scheren  
 Ciseaux à chirurgie  
 Tijeras para cirugía  
 Forbici per chirurgia



TC Cutting Edges  
 TC-Schneiden  
 Tranchant TC  
 Filos de corte TC  
 Taglio TC



**MAYO-STILLE**

15.0 cm **GD02.170.15**  
 17.0 cm **GD02.170.17**

**MAYO-STILLE**

15.0 cm **GD02.171.15**  
 17.0 cm **GD02.171.17**

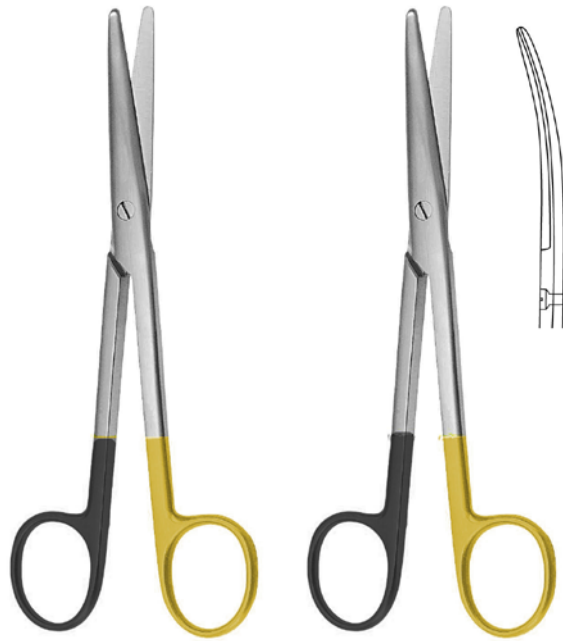

**MAYO-STILLE**

15.0 cm **GD02.174.15**  
 17.0 cm **GD02.174.17**

**MAYO-STILLE**

15.0 cm **GD02.175.15**  
 17.0 cm **GD02.175.17**



Operating Scissors  
Chirurgische Scheren  
Ciseaux à chirurgie  
Tijeras para cirugía  
Forbici per chirurgia

**GRAND**  
DEVICES  
*The Grand Instruments Company*



MAYO-NOBLE  
17.0 cm **GD02.180.17**



MAYO-NOBLE  
17.0 cm **GD02.181.17**



MAYO-NOBLE  
17.0 cm **GD02.184.17**

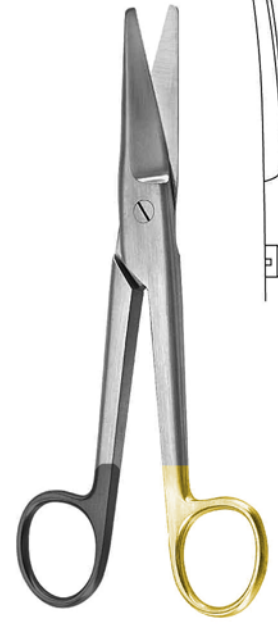

MAYO-NOBLE  
17.0 cm **GD02.185.17**

TC Cutting Edges  
TC-Schneiden  
Tranchant TC  
Filos de corte TC  
Taglio TC



Dissecting Scissors  
 Präparierscheren  
 Ciseaux à dissection  
 Tijeras de disección  
 Forbici per dissezione



TC Cutting Edges  
 TC-Schneiden  
 Tranchant TC  
 Filos de corte TC  
 Taglio TC

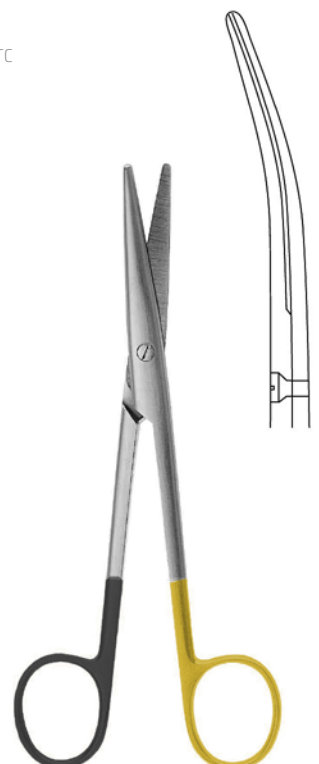

**LEXER**  
 16.0 cm **GD02.190.16**  
 21.0 cm **GD02.190.21**

**LEXER**  
 16.0 cm **GD02.191.16**  
 21.0 cm **GD02.191.21**

**LEXER**  
 16.0 cm **GD02.194.16**  
 21.0 cm **GD02.194.21**

**LEXER**  
 16.0 cm **GD02.195.16**  
 21.0 cm **GD02.195.21**



Dissecting Scissors  
Präparierscheren  
Ciseaux à dissection  
Tijeras de disección  
Forbici per dissezione

**GRAND**  
DEVICES  
*The Grand Instruments Company*



LEXER-BABY  
10.0 cm **GD02.202.10**



LEXER-BABY  
10.0 cm **GD02.203.10**



LEXER-BABY  
10.0 cm **GD02.206.10**



LEXER-BABY  
10.0 cm **GD02.207.10**

TC Cutting Edges  
TC-Schneiden  
Tranchant TC  
Filos de corte TC  
Taglio TC



TC Cutting Edges  
 TC-Schneiden  
 Tranchant TC  
 Filos de corte TC  
 Taglio TC



**METZENBAUM**

11.5 cm **GD02.280.11**  
 15.0 cm **GD02.280.15**  
 18.0 cm **GD02.280.18**  
 20.0 cm **GD02.280.20**  
 23.0 cm **GD02.280.23**  
 25.0 cm **GD02.280.25**  
 28.0 cm **GD02.280.28**  
 30.0 cm **GD02.280.30**



**METZENBAUM**

11.5 cm **GD02.281.11**  
 15.0 cm **GD02.281.15**  
 18.0 cm **GD02.281.18**  
 20.0 cm **GD02.281.20**  
 23.0 cm **GD02.281.23**  
 25.0 cm **GD02.281.25**  
 28.0 cm **GD02.281.28**  
 30.0 cm **GD02.281.30**



**METZENBAUM**

11.5 cm **GD02.284.11**  
 15.0 cm **GD02.284.15**  
 18.0 cm **GD02.284.18**  
 20.0 cm **GD02.284.20**  
 23.0 cm **GD02.284.23**  
 25.0 cm **GD02.284.25**  
 28.0 cm **GD02.284.28**  
 30.0 cm **GD02.284.30**



**METZENBAUM**

11.5 cm **GD02.285.11**  
 18.0 cm **GD02.285.18**  
 20.0 cm **GD02.285.20**  
 23.0 cm **GD02.285.23**  
 25.0 cm **GD02.285.25**  
 28.0 cm **GD02.285.28**  
 30.0 cm **GD02.285.30**





Dissecting Scissors  
Präparierscheren  
Ciseaux à dissection  
Tijeras de disección  
Forbici per dissezione

**GRAND**  
DEVICES  
*The Grand Instruments Company*



**METZENBAUM FINO**

15.0 cm **GD02.282.15**  
18.0 cm **GD02.282.18**  
20.0 cm **GD02.282.20**  
23.0 cm **GD02.282.23**  
25.0 cm **GD02.282.25**  
28.0 cm **GD02.282.28**



**METZENBAUM FINO**

15.0 cm **GD02.283.15**  
18.0 cm **GD02.283.18**  
20.0 cm **GD02.283.20**  
23.0 cm **GD02.283.23**  
25.0 cm **GD02.283.25**  
28.0 cm **GD02.283.28**



**METZENBAUM FINO**

15.0 cm **GD02.286.15**  
18.0 cm **GD02.286.18**  
20.0 cm **GD02.286.20**  
23.0 cm **GD02.286.23**  
25.0 cm **GD02.286.25**  
28.0 cm **GD02.286.28**

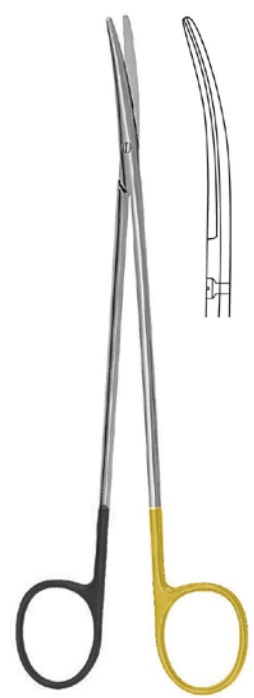

**METZENBAUM FINO**

15.0 cm **GD02.287.15**  
18.0 cm **GD02.287.18**  
20.0 cm **GD02.287.20**  
23.0 cm **GD02.287.23**  
25.0 cm **GD02.287.25**  
28.0 cm **GD02.287.28**

TC Cutting Edges  
TC-Schneiden  
Tranchant TC  
Filos de corte TC  
Taglio TC

Operating Scissors  
 Chirurgische Scheren  
 Ciseaux à chirurgie  
 Tijeras para cirugía  
 Forbici per chirurgia

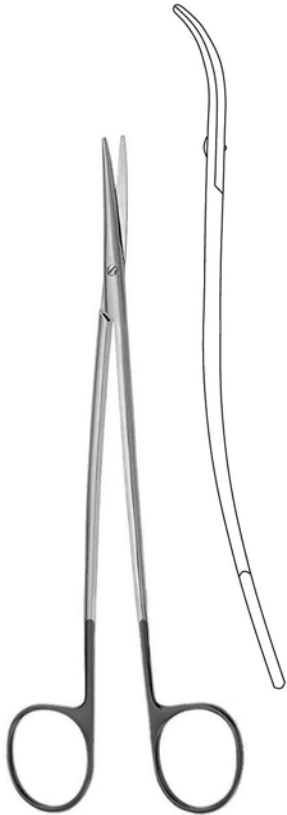

**METZENBAUM "S"**

18.0 cm **GD02.291.18**



**SANVENERO**

14.0 cm **GD02.302.14**



**SANVENERO**

14.0 cm **GD02.303.14.14**

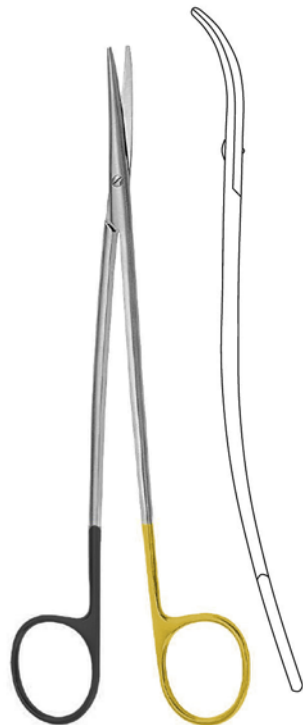

**METZENBAUM "S"**

18.0 cm **GD02.295.18**

TC Cutting Edges  
 TC-Schneiden  
 Tranchant TC  
 Filos de corte TC  
 Taglio TC



**SANVENERO**

14.0 cm **GD02.306.14**



**SANVENERO**

14.0 cm **GD02.307.14**



Operating Scissors  
Chirurgische Scheren  
Ciseaux à chirurgie  
Tijeras para cirugía  
Forbici per chirurgia

**GRAND**<sup>®</sup>  
DEVICES  
*The Grand Instruments Company*



**JOSEPH**  
14.0 cm **GD02.304.14**

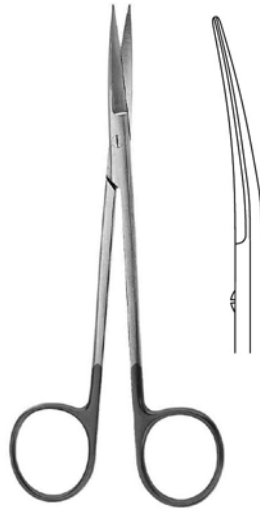

**JOSEPH**  
14.0 cm **GD02.305.14**



**KILNER**  
12.0 cm **GD02.310.12**  
15.0 cm **GD02.310.15**

TC Cutting Edges  
TC-Schneiden  
Tranchant TC  
Filos de corte TC  
Taglio TC



**JOSEPH**  
14.0 cm **GD02.308.14**



**JOSEPH**  
14.0 cm **GD02.309.14**



**KILNER**  
12.0 cm **GD02.314.12**  
15.0 cm **GD02.314.15**



Operating Scissors  
 Chirurgische Scheren  
 Ciseaux à chirurgie  
 Tijeras para cirugía  
 Forbici per chirurgia



REYNOLDS  
 15.0 cm GD02.320.15



REYNOLDS  
 15.0 cm GD02.321.15

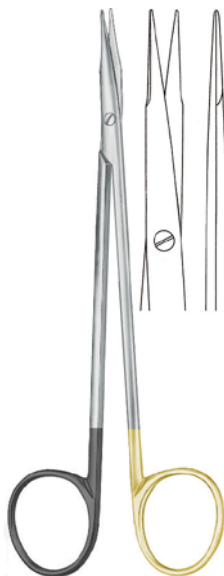

REYNOLDS  
 15.0 cm GD02.324.15

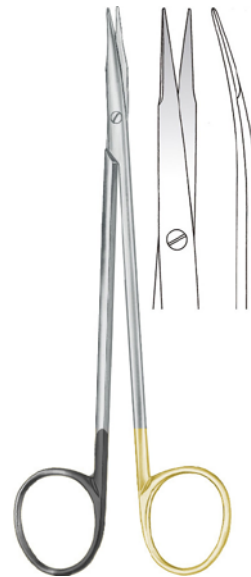

REYNOLDS  
 15.0 cm GD02.325.15

TC Cutting Edges  
 TC-Schneiden  
 Tranchant TC  
 Filos de corte TC  
 Taglio TC



Operating Scissors  
 Chirurgische Scheren  
 Ciseaux à chirurgie  
 Tijeras para cirugía  
 Forbici per chirurgia

**GRAND**  
 DEVICES  
*The Grand Instruments Company*



RIS-Standard

09.0 cm **GD02.340.09**  
 10.5 cm **GD02.340.10**  
 11.5 cm **GD02.340.11**



RIS-Standard

09.0 cm **GD02.341.09**  
 10.5 cm **GD02.341.10**  
 11.5 cm **GD02.341.11**



RIS-Standard

09.0 cm **GD02.342.09**  
 10.5 cm **GD02.342.10**  
 11.5 cm **GD02.342.11**



RIS-Standard

09.0 cm **GD02.343.09**  
 10.5 cm **GD02.343.10**  
 11.5 cm **GD02.343.11**

round  
 rund  
 rond  
 redondo  
 retondo



IRIS-Standard

09.0 cm **GD02.344.09**  
 10.5 cm **GD02.344.10**  
 11.5 cm **GD02.344.11**



IRIS-Standard

09.0 cm **GD02.345.09**  
 10.5 cm **GD02.345.10**  
 11.5 cm **GD02.345.11**

TC Cutting Edges  
 TC-Schneiden  
 Tranchant TC  
 Filos de corte TC  
 Taglio TC



Scissors, Ophthal, Nasal  
 Scheren, Ophthal, Nase  
 Ciseaux, ophtal, nasaux  
 Tijeras, oftalmología, nasales  
 Forbici, oftalmologia, nasali



straight  
 gerade  
 droites  
 rectas  
 rette

STEVENS

11.0 cm GD02.362.11



curved  
 gebogen  
 courbes  
 curvas  
 curve

STEVENS

11.0 cm GD02.363.11

Strabismus Scissors  
 Strabismus Scheren  
 Ciseaux à strabisme  
 Tijeras para estrabismo  
 Forbici per strabismo

TC Cutting Edges  
 TC-Schneiden  
 Tranchant TC  
 Filos de corte TC  
 Taglio TC



11.0 cm GD02.370.11



11.0 cm GD02.371.11



11.0 cm GD02.374.11



11.0 cm GD02.375.11



Scissors, Ophthal, Nasal  
Scheren, Ophthal, Nase  
Ciseaux, ophtal, nasaux  
Tijeras, oftalmología, nasales  
Forbici, oftalmologia, nasali

**GRAND**<sup>®</sup>  
DEVICES  
*The Grand Instruments Company*

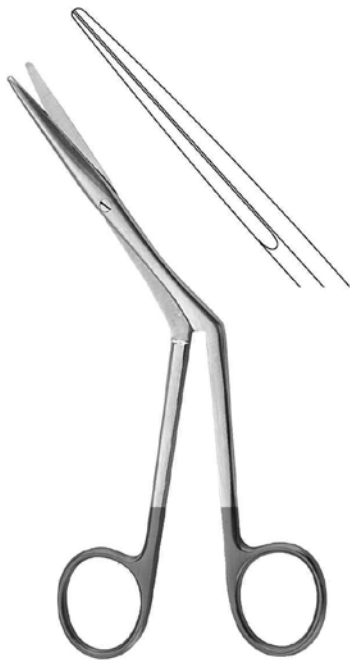

HEYMANN

18.0 cm GD02.401.18

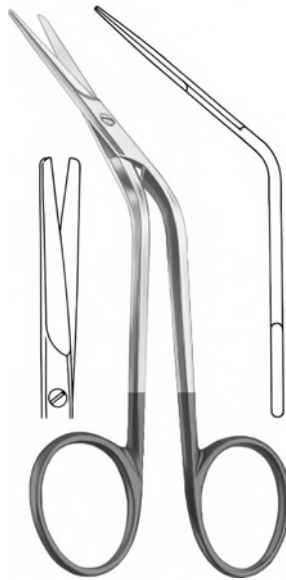

FOMON

15.0 cm GD02.403.15



COTTLE

16.0 cm GD02.405.16



Tonsil, Vascular Scissors  
 Tonsillen-, Gefäß-Scheren  
 Ciseaux amygdal., vasculaires  
 Tijeras, amígdal., vasculares  
 Forbici, tonsill., vascolari

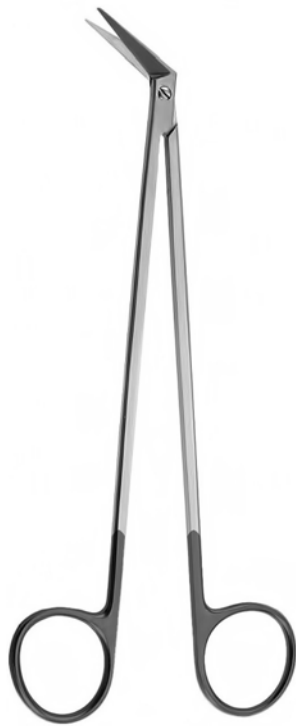

25°



40°

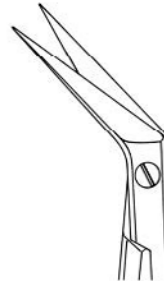

60°

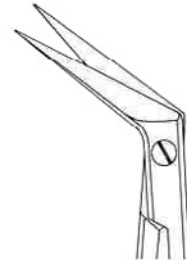

**POTTS-SMITH**

19.0 cm

**GD02.480.25**

**GD02.480.40**

**GD02.480.60**

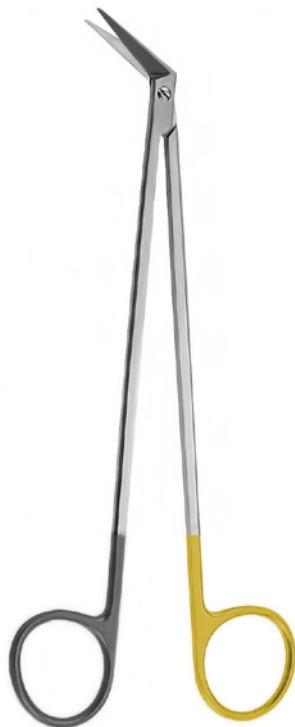

25°



40°

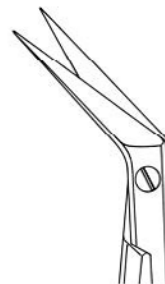

60°

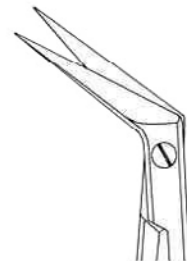

**POTTS-SMITH**

19.0 cm

**GD02.484.25**

**GD02.484.40**

**GD02.484.60**

- TC Cutting Edges
- TC-Schneiden
- Tranchant TC
- Filos de corte TC
- Taglio TC



Vascular Scissors  
Gefäß-Scheren  
Ciseaux vasculaires  
Tijeras vasculares  
Forbici vascolari

**GRAND**<sup>®</sup>  
DEVICES  
*The Grand Instruments Company*

parametrium



22.0 cm  
GD02.505.22

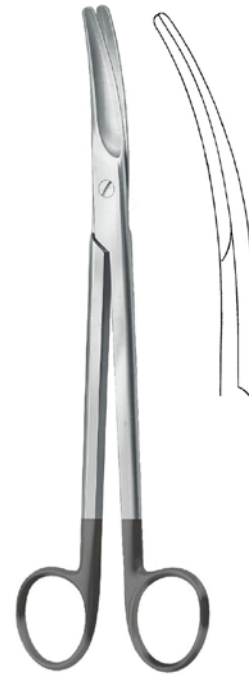

23.0 cm  
GD02.505.23

TC Cutting Edges  
TC-Schneiden  
Tranchant TC  
Filos de corte TC  
Taglio TC

Gynaecological Scissors  
 Gynäkologische Scheren  
 Ciseaux gynécologiques  
 Tijeras ginecológicas  
 Forbici ginecologiche



**SIMS**  
 20.0 cm **GD02.510.20**  
 23.0 cm **GD02.510.23**



**SIMS**  
 20.0 cm **GD02.511.20**  
 23.0 cm **GD02.511.23**



**SIEBOLD**  
 24.0 cm **GD02.523.24**

TC Cutting Edges  
 TC-Schneiden  
 Tranchant TC  
 Filos de corte TC  
 Taglio TC



**SIMS**  
 20.0 cm **GD02.514.20**  
 23.0 cm **GD02.514.23**



**SIMS**  
 20.0 cm **GD02.515.20**  
 23.0 cm **GD02.515.23**



Gynaecological Scissors  
Gynäkologische Scheren  
Ciseaux gynécologiques  
Tijeras ginecológicas  
Forbici ginecologiche

**GRAND**  
DEVICES  
The Grand Instruments Company



**KELLY**

16.0 cm **GD02.540.16**  
18.0 cm **GD02.540.18**



**KELLY**

16.0 cm **GD02.541.16**  
18.0 cm **GD02.541.18**



Episiotomy  
Episiotomie  
Episiotomia  
Episiotmia  
Episiotomia

**BRAUN-STADLER**

14.5 cm **GD02.560.14**  
22.0 cm **GD02.560.22**



**WAGNER**

12.0 cm **GD02.824-12**



**WAGNER**

12.0 cm **GD02.825.12**





**LISTER**

14.0 cm **GD02.901.14**  
18.0 cm **GD02.901.18**  
20.0 cm **GD02.901.20**

TC Cutting Edges  
TC-Schneiden  
Tranchant TC  
Filos de corte TC  
Taglio TC



**LISTER**

14.0 cm **GD02.905.14**  
18.0 cm **GD02.905.18**  
20.0 cm **GD02.905.20**



Scissors  
Scheren  
Ciseaux  
Tijeras  
Forbici  
剪刀



**GD03**



Operating Scissors  
 Chirurgische Scheren  
 Ciseaux à chirurgie  
 Tijeras para cirugía  
 Forbici per chirurgia

**GRAND**  
 DEVICES  
 The Grand Instruments Company

TC Cutting Edges  
 TC-Schneiden  
 Tranchant TC  
 Filos de corte TC  
 Taglio TC

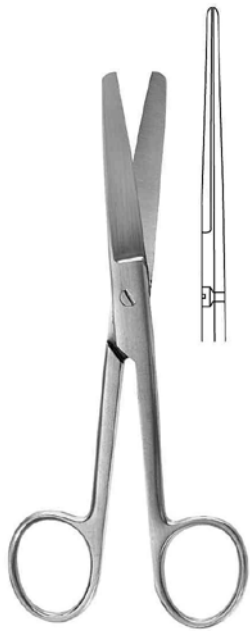

STANDARD

10.5 cm **GD03.102.10**  
 11.5 cm **GD03.102.11**  
 13.0 cm **GD03.102.13**  
 14.5 cm **GD03.102.14**  
 15.5 cm **GD03.102.15**  
 16.5 cm **GD03.102.16**  
 18.5 cm **GD03.102.18**  
 20.0 cm **GD03.102.20**  
 30.0 cm **GD03.102.30**

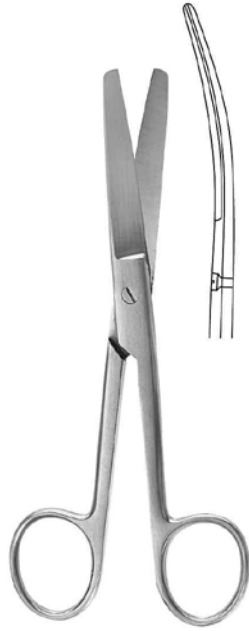

STANDARD

10.5 cm **GD03.103.10**  
 11.5 cm **GD03.103.11**  
 13.0 cm **GD03.103.13**  
 14.5 cm **GD03.103.14**  
 15.5 cm **GD03.103.15**  
 16.5 cm **GD03.103.16**  
 18.5 cm **GD03.103.18**  
 20.0 cm **GD03.103.20**  
 30.0 cm **GD03.103.30**



Standard

14.5 cm  
**GD03.104.14**  
 16.5 cm  
**GD03.104.16**  
 18.5 cm  
**GD03.104.18**

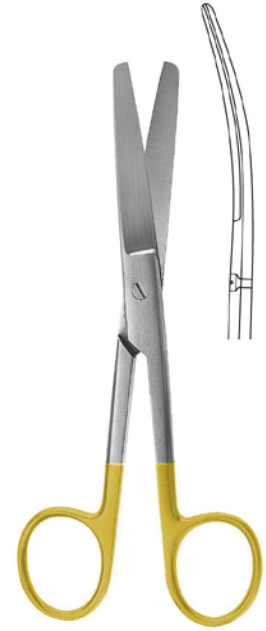

Standard

14.5 cm **GD03.105.14**  
 16.5 cm **GD03.105.16**  
 18.5 cm **GD03.105.18**

Operating Scissors  
Chirurgische Scheren  
Ciseaux à chirurgie  
Tijeras para cirugía  
Forbici per chirurgia



TC Cutting Edges  
TC-Schneiden  
Tranchant TC  
Filos de corte TC  
Taglio TC

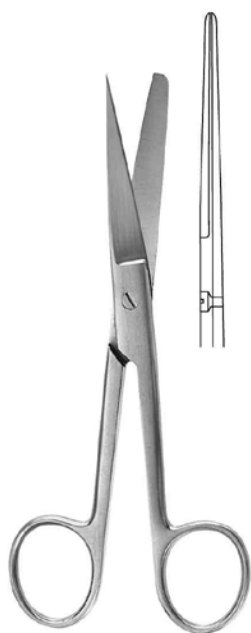

STANDARD

0.5 cm **GD03.110.10**  
11.5 cm **GD03.110.11**  
13.0 cm **GD03.110.13**  
13.0 cm **GD03.110.13L**  
14.5 cm **GD03.110.14**  
14.5 cm **GD03.110.14L**  
15.5 cm **GD03.110.15**  
16.5 cm **GD03.110.16**  
18.5 cm **GD03.110.18**  
20.0 cm **GD03.110.20**  
30.0 cm **GD03.110.30**

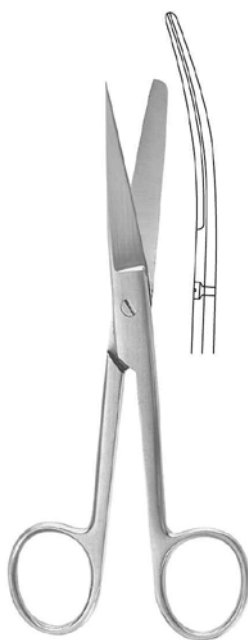

STANDARD

10.5 cm **GD03.111.10**  
11.5 cm **GD03.111.11**  
13.0 cm **GD03.111.13**  
13.0 cm **GD03.111.13L**  
14.5 cm **GD03.111.14**  
14.5 cm **GD03.111.14L**  
15.5 cm **GD03.111.15**  
16.5 cm **GD03.111.16**  
18.5 cm **GD03.111.18**  
20.0 cm **GD03.111.20**  
30.0 cm **GD03.111.30**



Standard

14.5 cm  
**GD03.114.14**  
16.5 cm  
**GD03.114.16**  
18.5 cm  
**GD03.114.18**

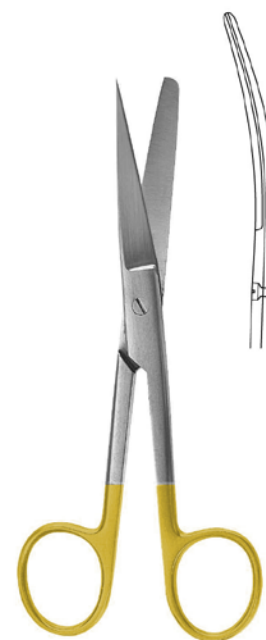

Standard

14.5 cm **GD03.115.14**  
16.5 cm **GD03.115.16**  
18.5 cm **GD03.115.18**

L = For left-handed / Für Linkshänder  
Pour la main gauche / Para zurdo / Per mancini





Operating Scissors  
Chirurgische Scheren  
Ciseaux à chirurgie  
Tijeras para cirugía  
Forbici per chirurgia

**GRAND**  
DEVICES  
*The Grand Instruments Company*

TC Cutting Edges  
TC-Schneiden  
Tranchant TC  
Filos de corte TC  
Taglio TC

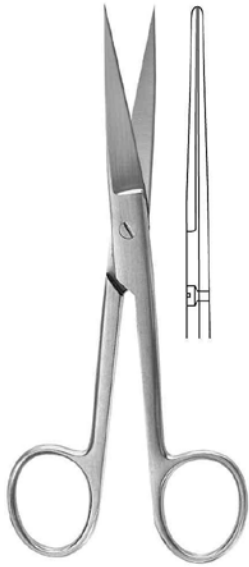

STANDARD

10.5 cm **GD03.120.10**  
11.5 cm **GD03.120.11**  
13.0 cm **GD03.120.13**  
14.5 cm **GD03.120.14**  
15.5 cm **GD03.120.15**  
16.5 cm **GD03.120.16**  
18.5 cm **GD03.120.18**  
20.0 cm **GD03.120.20**  
30.0 cm **GD03.120.30**

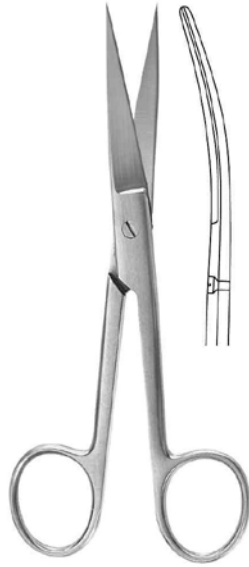

STANDARD

10.5 cm **GD03.121.10**  
11.5 cm **GD03.121.11**  
13.0 cm **GD03.121.13**  
14.5 cm **GD03.121.14**  
15.5 cm **GD03.121.15**  
16.5 cm **GD03.121.16**  
18.5 cm **GD03.121.18**  
20.0 cm **GD03.121.20**  
30.0 cm **GD03.121.30**



Standard

14.5 cm **GD03.124.14**  
16.5 cm **GD03.124.16**  
18.5 cm **GD03.124.18**



Standard

14.5 cm **GD03.125.14**  
16.5 cm **GD03.125.16**  
18.5 cm **GD03.125.18**



Slender patterns  
schlanke Modelle  
modèles fins  
modelos fins  
modelli fini



12.0 cm **GD03.124.12**



12.0 cm **GD03.125.12**



12.0 cm **GD03.126.12**  
13.0 cm **GD03.126.13**



12.0 cm **GD03.127.12**  
13.0 cm **GD03.127.13**

Incision scissors  
Inzisionsscheren  
Ciseaux à incision  
Tijeras para incision  
Forbici incisione



14.0 cm **GD03.128.14**



Operating Scissors  
Chirurgische Scheren  
Ciseaux à chirurgie  
Tijeras para cirugía  
Forbici per chirurgia

**GRAND**<sup>®</sup>  
DEVICES  
*The Grand Instruments Company*

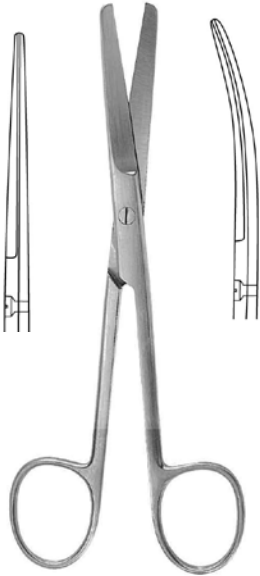

DEAVER

14.0 cm **GD03.130.14**  
**GD03.131.14**

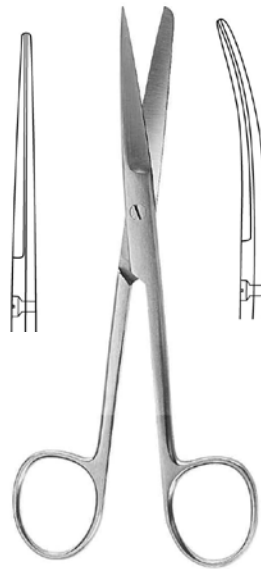

DEAVER

14.0 cm **GD03.140.14**  
**GD03.141.14**

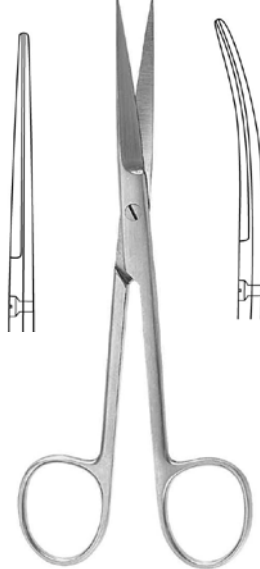

DEAVER

14.0 cm **GD03.150.14**  
**GD03.151.14**

TC Cutting Edges  
TC-Schneiden  
Tranchant TC  
Filos de corte TC  
Taglio TC

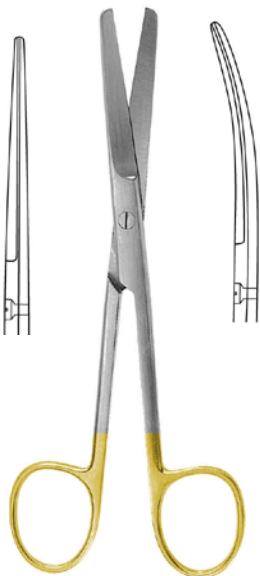

DEAVER

14.0 cm **GD03.134.14**  
**GD03.135.14**

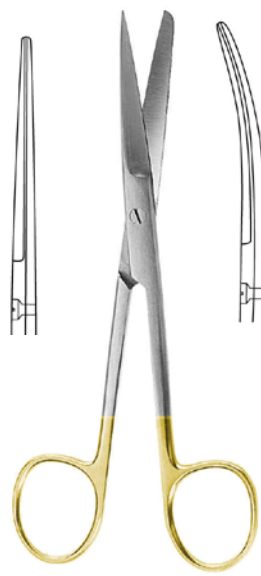

DEAVER

14.0 cm **GD03.1GD03.14**  
**GD03.145.14**

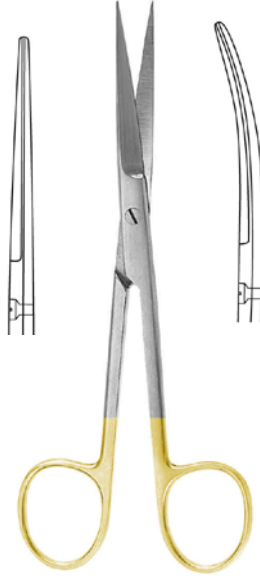

DEAVER

14.0 cm **GD03.154.14**  
**GD03.155.14**



TC Cutting Edges  
 TC-Schneiden  
 Tranchant TC  
 Filos de corte TC  
 Taglio TC



**MAYO**

14.5 cm **GD03.160.14**  
 14.5 cm **GD03.160.14L**  
 17.0 cm **GD03.160.17**  
 17.0 cm **GD03.160.17L**  
 19.0 cm **GD03.160.19**  
 23.0 cm **GD03.160.23**  
 28.0 cm **GD03.160.28**

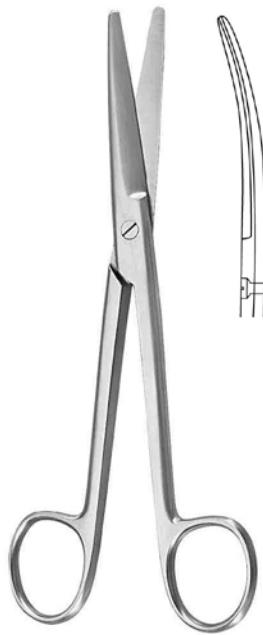

**MAYO**

14.5 cm **GD03.161.14**  
 14.5 cm **GD03.161.14L**  
 17.0 cm **GD03.161.17**  
 17.0 cm **GD03.161.17L**  
 19.0 cm **GD03.161.19**  
 23.0 cm **GD03.161.23**  
 28.0 cm **GD03.161.28**



**MAYO**

14.5 cm **GD03.164.14**  
 17.0 cm **GD03.164.17**  
 23.0 cm **GD03.164.23**



**MAYO**

14.5 cm **GD03.165.14**  
 17.0 cm **GD03.165.17**  
 23.0 cm **GD03.165.23**

L = For left-handed / Für Linkshänder  
 Pour la main gauche / Para zurdo / Per mancini



Operating Scissors  
Chirurgische Scheren  
Ciseaux à chirurgie  
Tijeras para cirugía  
Forbici per chirurgia

**GRAND**  
DEVICES  
*The Grand Instruments Company*

slender patterns  
schlanke Modelle  
modèles fins  
modelos fins  
modelli fini



**MAYO-STILLE**

16.0 cm **GD03.166.16**  
19.0 cm **GD03.166.19**  
21.5 cm **GD03.166.21**



**MAYO-STILLE**

16.0 cm **GD03.167.16**  
19.0 cm **GD03.167.19**  
21.5 cm **GD03.167.21**



**MAYO-STILLE**

14.0 cm **GD03.172.14**  
17.0 cm **GD03.172.17**



**MAYO-STILLE**

14.0 cm **GD03.173.14**  
17.0 cm **GD03.173.17**

with chamfered blades  
mit Abgeschägten Schneiden  
avec tranchant biais  
filos en declive  
con lame inclinate



Dissecting Scissors  
 Präparierscheren  
 Ciseaux à dissection  
 Tijeras de disección  
 Forbici per dissezione



		<p>TC Cutting Edges                  TC-Schneiden                  Tranchant TC                  Filos de corte TC                  Taglio TC</p>			
<p><b>MAYO-STILLE</b>                  15.0 cm <b>GD03.170.15</b>                  17.0 cm <b>GD03.170.17</b></p>		<p><b>MAYO-STILLE</b>                  15.0 cm <b>GD03.171.15</b>                  17.0 cm <b>GD03.171.17</b></p>		<p><b>MAYO-STILLE</b>                  15.0 cm <b>GD03.174.15</b>                  17.0 cm <b>GD03.174.17</b></p>	
		<p><b>MAYO-STILLE</b>                  15.0 cm <b>GD03.175.15</b>                  17.0 cm <b>GD03.175.17</b></p>			



Operating Scissors  
Chirurgische Scheren  
Ciseaux à chirurgie  
Tijeras para cirugía  
Forbici per chirurgia

**GRAND**<sup>®</sup>  
DEVICES  
*The Grand Instruments Company*



MAYO-NOBLE  
17.0 cm **GD03.180.17**



MAYO-NOBLE  
17.0 cm **GD03.181.17**



MAYO-NOBLE  
17.0 cm **GD03.184.17**

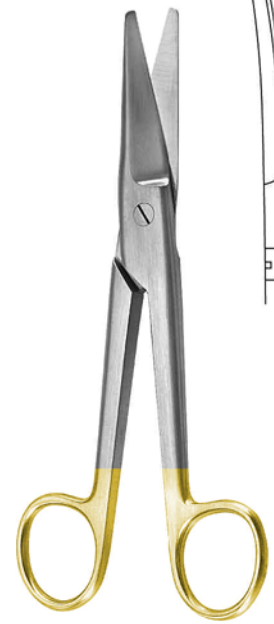

MAYO-NOBLE  
17.0 cm **GD03.185.17**

TC Cutting Edges  
TC-Schneiden  
Tranchant TC  
Filos de corte TC  
Taglio TC



Dissecting Scissors  
 Präparierscheren  
 Ciseaux à dissection  
 Tijeras de disección  
 Forbici per dissezione



LEXER

16.0 cm **GD03.190.16**  
 21.0 cm **GD03.190.21**

LEXER

16.0 cm **GD03.191.16**  
 21.0 cm **GD03.191.21**



TC Cutting Edges  
 TC-Schneiden  
 Tranchant TC  
 Filos de corte TC  
 Taglio TC

LEXER

16.0 cm **GD03.194.16**  
 21.0 cm **GD03.194.21**

LEXER

16.0 cm **GD03.195.16**  
 21.0 cm **GD03.195.21**



Dissecting Scissors  
Präparierscheren  
Ciseaux à dissection  
Tijeras de disección  
Forbici per dissezione

**GRAND**  
DEVICES  
*The Grand Instruments Company*

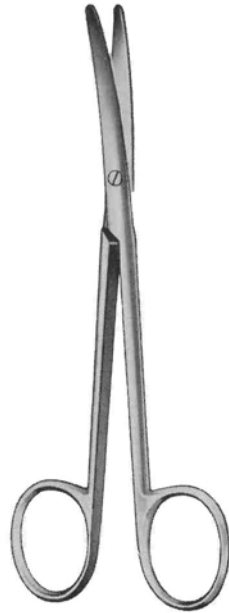

**LEXER-FINO**

16.0 cm  
**GD03.197.16**



**LEXER-BABY**

10.0 cm **GD03.202.10**



**LEXER-BABY**

10.0 cm **GD03.203.10**



**LEXER-BABY**

10.0 cm  
**GD03.206.10**



**LEXER-BABY**

10.0 cm **GD03.207.10**

TC Cutting Edges  
TC-Schneiden  
Tranchant TC  
Filos de corte TC  
Taglio TC

Dissecting Scissors  
 Präparierscheren  
 Ciseaux à dissection  
 Tijeras de disección  
 Forbici per dissezione



tips with eye for suture  
 mit Fadenbohrung in der Spitze  
 avec chas  
 con ojal en las puntas Forbici  
 con foro per il filo alla punta



**LITTLER**  
 12.0 cm **GD03.205.12**  
 14.0 cm **GD03.205.14**



**METZENBAUM**  
 11.5 cm **GD03.210.11**  
 15.5 cm **GD03.210.15**



**METZENBAUM**  
 11.5 cm **GD03.211.11**  
 15.5 cm **GD03.211.15**



**GORNEY**  
 12.0 cm **GD03.212.12**  
 19.0 cm **GD03.212.19**



**GORNEY**  
 19.0 cm **GD03.213.19**



Dissecting Scissors  
Präparierscheren  
Ciseaux à dissection  
Tijeras de disección  
Forbici per dissezione

**GRAND**  
DEVICES  
The Grand Instruments Company

TC Cutting Edges  
TC-Schneiden  
Tranchant TC  
Filos de corte TC  
Taglio TC



**METZENBAUM**

15.0 cm **GD03.280.15**  
15.0 cm **GD03.280.15L**  
18.0 cm **GD03.280.18**  
18.0 cm **GD03.280.18L**  
20.0 cm **GD03.280.20**  
23.0 cm **GD03.280.23**  
23.0 cm **GD03.280.23L**  
25.0 cm **GD03.280.25**  
28.0 cm **GD03.280.28**  
30.0 cm **GD03.280.30**

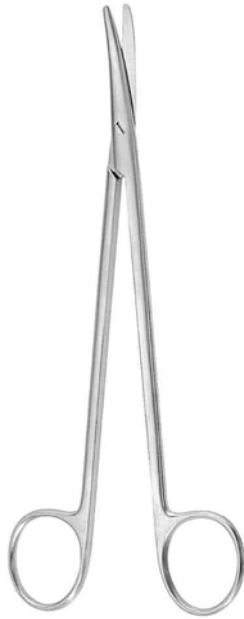

**METZENBAUM**

15.0 cm **GD03.281.15**  
15.0 cm **GD03.281.15L**  
18.0 cm **GD03.281.18**  
18.0 cm **GD03.281.18L**  
20.0 cm **GD03.281.20**  
23.0 cm **GD03.281.23**  
23.0 cm **GD03.281.23L**  
25.0 cm **GD03.281.25**  
28.0 cm **GD03.281.28**  
30.0 cm **GD03.281.30**



**METZENBAUM**

15.0 cm **GD03.284.15**  
18.0 cm **GD03.284.18**  
20.0 cm **GD03.284.20**  
23.0 cm **GD03.284.23**  
25.0 cm **GD03.284.25**  
28.0 cm **GD03.284.28**  
30.0 cm **GD03.284.30**



**METZENBAUM**

15.0 cm **GD03.285.15**  
18.0 cm **GD03.285.18**  
20.0 cm **GD03.285.20**  
23.0 cm **GD03.285.23**  
25.0 cm **GD03.285.25**  
28.0 cm **GD03.285.28**  
30.0 cm **GD03.285.30**

L = For left-handed / Für Linkshänder /  
Pour la main gauche / Para zurdo / Per mancini





**METZENBAUM FINO**

15.0 cm **GD03.282.15**  
 18.0 cm **GD03.282.18**  
 20.0 cm **GD03.282.20**  
 23.0 cm **GD03.282.23**  
 25.0 cm **GD03.282.25**  
 28.0 cm **GD03.282.28**



**METZENBAUM FINO**

15.0 cm **GD03.283.15**  
 18.0 cm **GD03.283.18**  
 20.0 cm **GD03.283.20**  
 23.0 cm **GD03.283.23**  
 25.0 cm **GD03.283.25**  
 28.0 cm **GD03.283.28**



**METZENBAUM FINO**

15.0 cm **GD03.286.15**  
 18.0 cm **GD03.286.18**  
 20.0 cm **GD03.286.20**  
 23.0 cm **GD03.286.23**  
 25.0 cm **GD03.286.25**  
 28.0 cm **GD03.286.28**

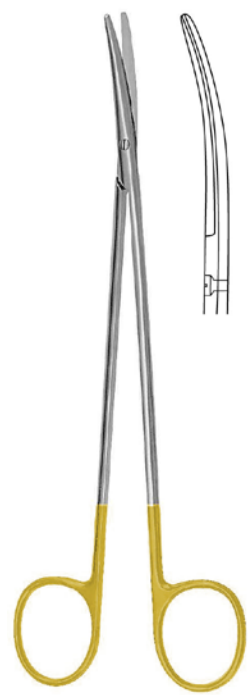

**METZENBAUM FINO**

15.0 cm **GD03.287.15**  
 18.0 cm **GD03.287.18**  
 20.0 cm **GD03.287.20**  
 23.0 cm **GD03.287.23**  
 25.0 cm **GD03.287.25**  
 28.0 cm **GD03.287.28**

TC Cutting Edges  
 TC-Schneiden  
 Tranchant TC  
 Filos de corte TC  
 Taglio TC



Dissecting Scissors  
Präparierscheren  
Ciseaux à dissection  
Tijeras de disección  
Forbici per dissezione

**GRAND**  
DEVICES  
The Grand Instruments Company

TC Cutting Edges  
TC-Schneiden  
Tranchant TC  
Filos de corte TC  
Taglio TC

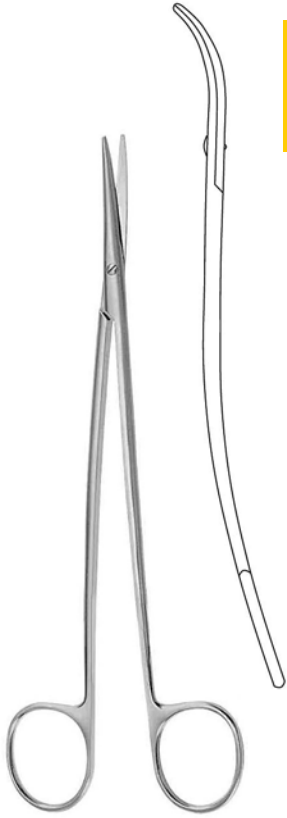

**METZENBAUM "S"**  
18.0 cm  
GD03.291.18

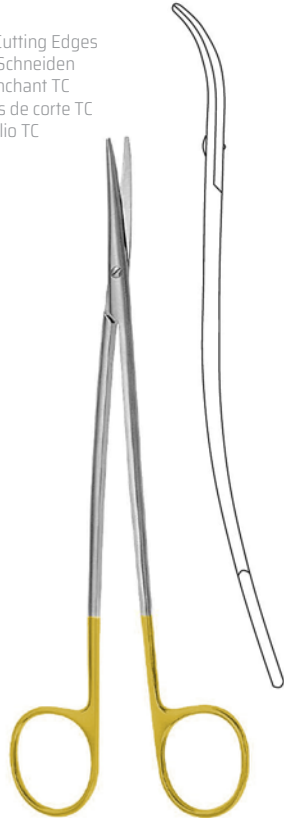

**METZENBAUM "S"**  
18.0 cm  
GD03.295.18  
23.0 cm  
GD03.295.23



**SANVENERO**  
14.0 cm  
GD03.302.14



**SANVENERO**  
14.0 cm  
GD03.303.14



**JOSEPH**  
14.0 cm  
GD03.304.14

Plastic  
Plastik  
Plastique  
Plástica  
Plastica



**JOSEPH**  
14.0 cm  
GD03.305.14



Plastic  
Plastik  
Plastique  
Plástica  
Plastica

TC Cutting Edges  
TC-Schneiden  
Tranchant TC  
Filos de corte TC  
Taglio TC



**KILNER**  
12.0 cm  
**GD03.308.12**



**KILNER**  
12.0 cm **GD03.310.12**  
15.0 cm **GD03.310.15**



**KILNER**  
12.0 cm  
**GD03.314.12**  
15.0 cm  
**GD03.314.15**



Operating Scissors  
 Chirurgische Scheren  
 Ciseaux à chirurgie  
 Tijeras para cirugía  
 Forbici per chirurgia

**GRAND**  
 DEVICES  
 The Grand Instruments Company

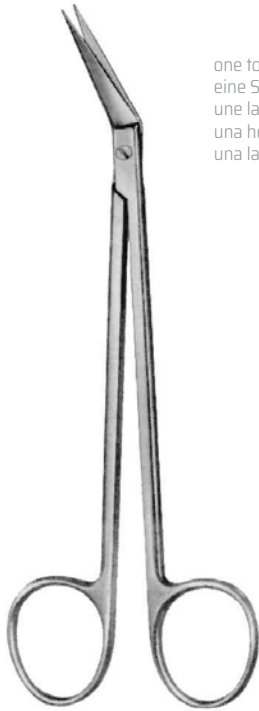

one toothed cutting edge  
 eine Schneide gezahnt  
 une lame dentelée  
 una hoja dentada  
 una lama dentata

**LOCKLIN**  
 16.0 cm  
**GD03.315.16**



**LOCKLIN**  
 16.0 cm **GD03.317.16**

Plastic  
 Plastik  
 Plastique  
 Plástica  
 Plastica

TC Cutting Edges  
 TC-Schneiden  
 Tranchant TC  
 Filos de corte TC  
 Taglio TC

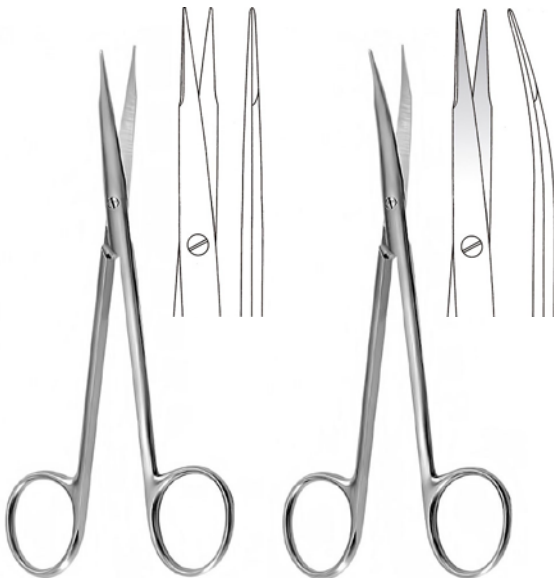

**REYNOLDS**  
 15.0 cm  
**GD03.320.15**

**REYNOLDS**  
 15.0 cm **GD03.321.15**  
 18.0 cm **GD03.321.18**

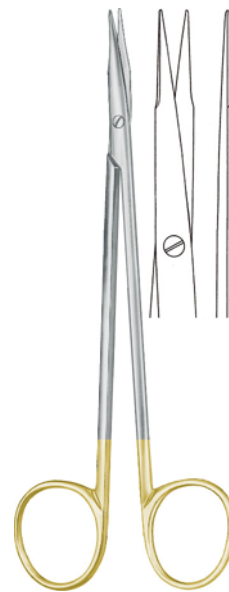

**REYNOLDS**  
 15.0 cm  
**GD03.324.15**

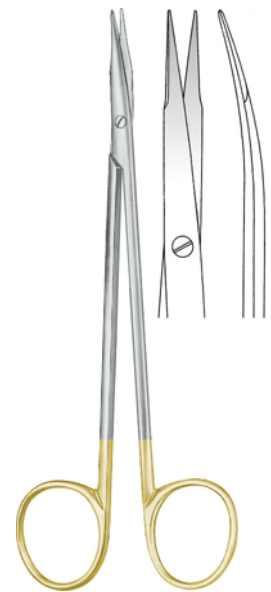

**REYNOLDS**  
 15.0 cm  
**GD03.325.15**



IRIS  
9.5 cm  
GD03.322.09



IRIS  
9.5 cm  
GD03.323.09



IRIS  
10.5 cm  
GD03.326.10



IRIS  
10.5 cm  
GD03.327.10



IRIS  
10.0 cm  
GD03.328.10



IRIS  
10.0 cm  
GD03.329.10



IRIS  
9.5 cm  
GD03.331.09



IRIS  
9.5 cm  
GD03.333.09



Operating Scissors  
Chirurgische Scheren  
Ciseaux à chirurgie  
Tijeras para cirugía  
Forbici per chirurgia

**GRAND**  
DEVICES  
*The Grand Instruments Company*



KNAPP  
10.5 cm **GD03.336.10**



KNAPP  
10.5 cm **GD03.337.10**



KNAPP  
10.5 cm **GD03.338.10**



KNAPP  
10.5 cm **GD03.339.10**





IRIS-Standard

9.0 cm **GD03.340.09**  
 10.5 cm **GD03.340.10**  
 10.5 cm **GD03.340.10L**  
 11.5 cm **GD03.340.11**  
 12.5 cm **GD03.340.12**



IRIS-Standard

9.0 cm **GD03.341.09**  
 10.5 cm **GD03.341.10**  
 10.5 cm **GD03.341.10L**  
 11.5 cm **GD03.341.11**  
 12.5 cm **GD03.341.12**



IRIS-Standard

10.5 cm **GD03.342.10**  
 11.5 cm **GD03.342.11**



IRIS-Standard

10.5 cm **GD03.343.10**  
 11.5 cm **GD03.343.11**

rund  
 round  
 rond  
 redondo  
 retondo

L = Für Linkshänder / For left-handed / Pour la main gauche / Para zurdo / Per mancini



IRIS-Standard

11.5 cm  
**GD03.3GD03.11**

TC Cutting Edges  
 TC-Schneiden  
 Tranchant TC  
 Filos de corte TC  
 Taglio TC

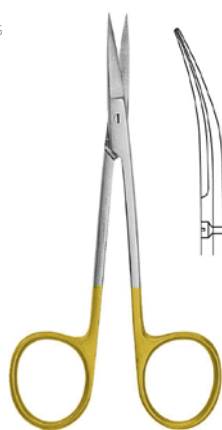

IRIS-Standard

11.5 cm **GD03.345.11**



Scissors, Ophthal, Nasal  
Scheren, Ophthal, Nase  
Ciseaux, ophtal, nasaux  
Tijeras, oftalmología, nasales  
Forbici, oftalmologia, nasali

**GRAND**  
DEVICES  
*The Grand Instruments Company*



**AEBLI**  
9.0 cm **GD03.347.09**

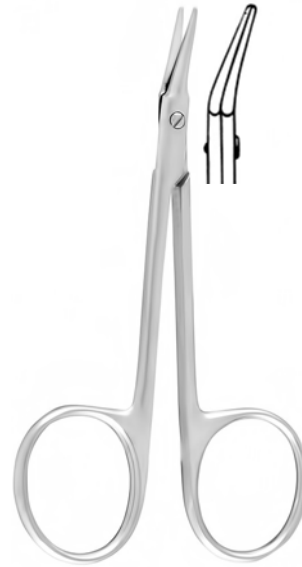

**AEBLI**  
9.0 cm  
**GD03.349.09**



**IRIS**  
11.5 cm **GD03.351.11**



**IRIS**  
11.5 cm **GD03.354.11**

Scissors, Ophthal, Nasal  
 Scheren, Ophthal, Nase  
 Ciseaux, ophtal, nasaux  
 Tijeras, oftalmología, nasales  
 Forbici, oftalmologia, nasali



pointed  
 spitz  
 pointus  
 agudas  
 acute

blunt  
 stumpf  
 mousses  
 romas  
 smusse



straight  
 gerade  
 droites  
 rectas  
 rette

STEVENS

10.5 cm **GD03.360.11**  
 10.5 cm **GD03.360.10**



curved  
 gebogen  
 courbes  
 curvas  
 curve

STEVENS

10.5 cm **GD03.361.11**  
 10.5 cm **GD03.361.10**



straight  
 gerade  
 droites  
 rectas  
 rette

STEVENS

10.5 cm **GD03.362.11**  
 10.5 cm **GD03.362.10**



curved  
 gebogen  
 courbes  
 curvas  
 curve

STEVENS

10.5 cm **GD03.363.11**  
 10.5 cm **GD03.363.10**

TC Cutting Edges  
 TC-Schneiden  
 Tranchant TC  
 Filos de corte TC  
 Taglio TC

pointed  
 spitz  
 pointus  
 agudas  
 acute



STEVENS

10.5 cm **GD03.364.10**



STEVENS

10.5 cm **GD03.365.10**



STEVENS

10.5 cm **GD03.366.10**



STEVENS

10.5 cm **GD03.367.10**



Scissors, Ophthal, Nasal  
Scheren, Ophthal, Nase  
Ciseaux, ophtal, nasaux  
Tijeras, oftalmología, nasales  
Forbici, oftalmologia, nasali

**GRAND**  
DEVICES  
*The Grand Instruments Company*



10.0 cm **GD03.369.10**



12.5 cm  
**GD03.369.12**

Strabismus scissors  
Strabismusscheren  
Ciseaux à strabisme  
Tijeras para estrabismo  
Forbici per strabismo

TC Cutting Edges  
TC-Schneiden  
Tranchant TC  
Filos de corte TC  
Taglio TC



11.0 cm  
**GD03.370.11**



11.0 cm **GD03.371.11**



11.0 cm **GD03.374.11**



11.0 cm  
**GD03.375.11**



Enucleation scissors  
 Enukleationsscheren  
 Ciseaux à énucléation  
 Tijeras para enucleación  
 Forbici per enucleazione

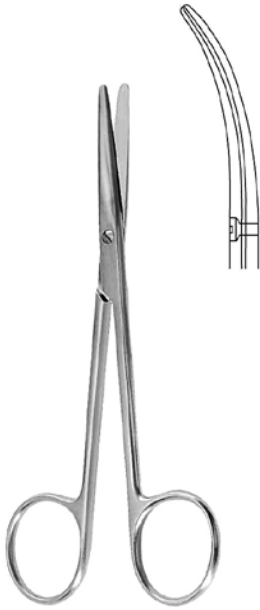

**LANDOLT**

11.0 cm  
**GD03.381.11**  
 13.0 cm  
**GD03.381.13**

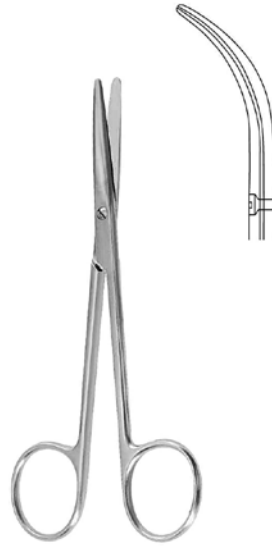

**LANDOLT**

13.0 cm **GD03.383.13**



**HEYMANN**

18.0 cm **GD03.401.18**

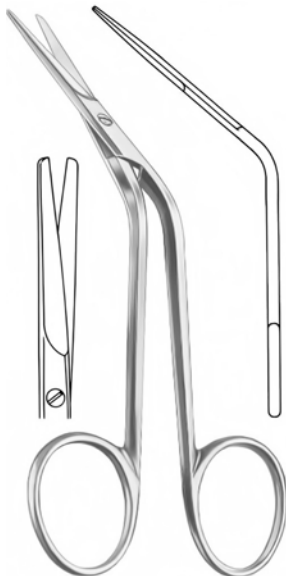

**FOMON**

14.0 cm  
**GD03.403.14**  
 15.0 cm  
**GD03.403.15**



**COTTLE**

16.0 cm **GD03.405.16**



**COTTLE**

16.0 cm **GD03.407.16**

TC Cutting Edges  
 TC-Schneiden  
 Tranchant TC  
 Filos de corte TC  
 Taglio TC



Tonsil, Vascular Scissors  
Tonsillen-, Gefäß-Scheren  
Ciseaux amygdal, vasculaires  
Tijeras, amígdal., vasculares  
Forbici, tonsill, vascolari

**GRAND**  
DEVICES  
The Grand Instruments Company

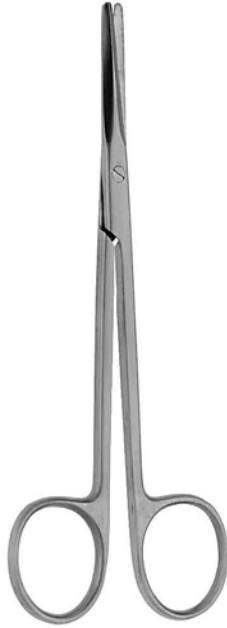

**BEUSE**

14.0 cm  
**GD03.420.14**  
18.0 cm  
**GD03.420.18**



**BEUSE**

14.0 cm **GD03.421.14**  
18.0 cm **GD03.421.18**



**DEAN**

17.0 cm  
**GD03.425.17**

angled upwards  
aufgewinkelt  
coudée en haut  
angulada  
angolari sul piatto



**DEAN**

17.0 cm **GD03.427.17**

toothed, angled upwards  
gezahnt, aufgewinkelt  
dentelés, coudée en haut  
dentada, angulada  
dentate, angolari sul piatto



Tonsil, Vascular Scissors  
 Tonsillen-, Gefäß-Scheren  
 Ciseaux amygdal, vasculaires  
 Tijeras, amígdal, vasculares  
 Forbici, tonsill, vascolari

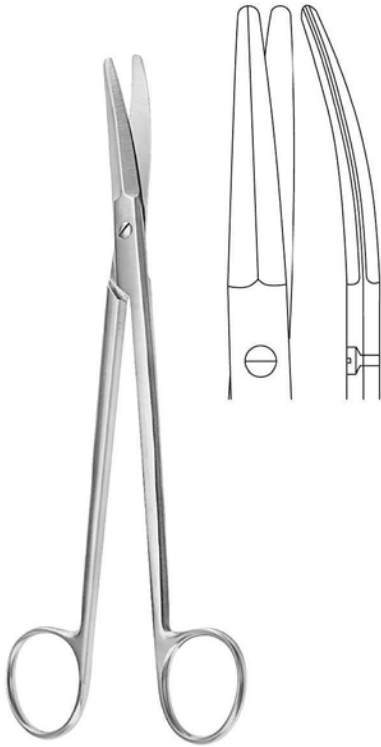

**BOETTCHER**  
 18.0 cm  
**GD03.435.18**

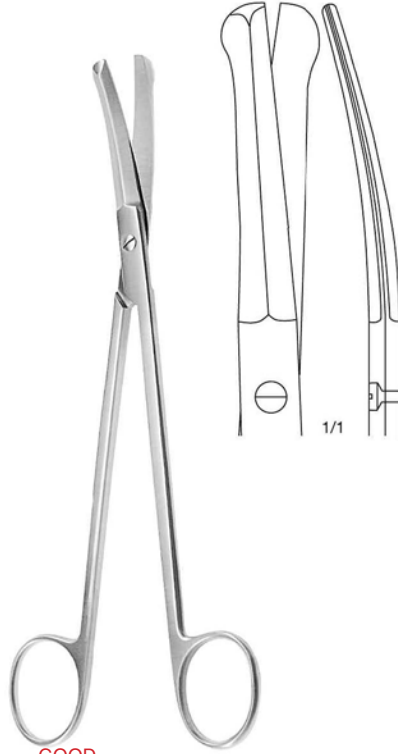

**GOOD**  
 19.0 cm **GD03.437.19**

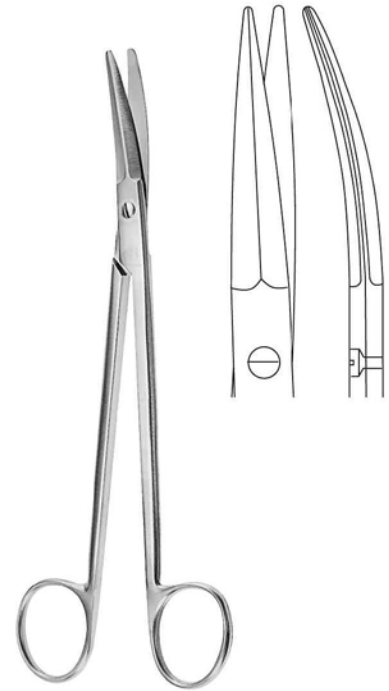

**PRINCE**  
 17.0 cm  
**GD03.439.17**



15.0 cm **GD03.468.15**



11.0 cm **GD03.470.11**

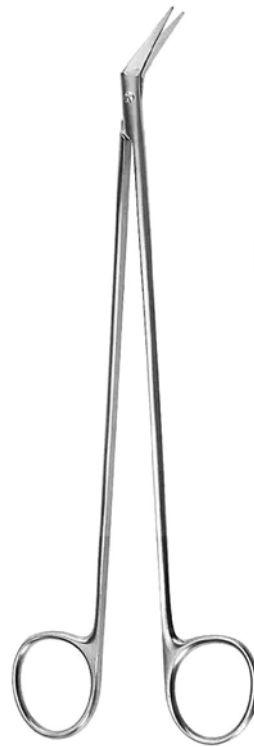

**POTTS-DE MARTEL**  
 21.0 cm **GD03.473.21**  
 24.0 cm **GD03.473.24**



**MILLS**  
 22.0 cm  
**GD03.475.22**



Vascular Scissors  
Gefäß-Scheren  
Ciseaux vasculaires  
Tijeras vasculares  
Forbici vascolari

**GRAND**<sup>®</sup>  
DEVICES  
*The Grand Instruments Company*

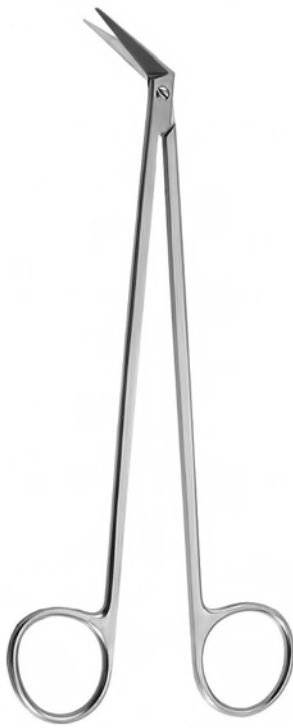

25°



40°

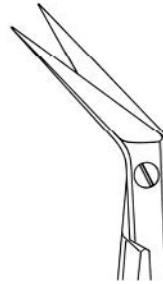

60°

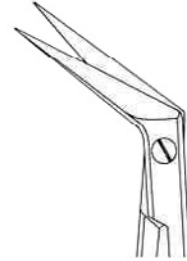

**POTTS-SMITH**

19.0 cm **GD03.480.25**

**GD03.480.40**

**GD03.480.60**

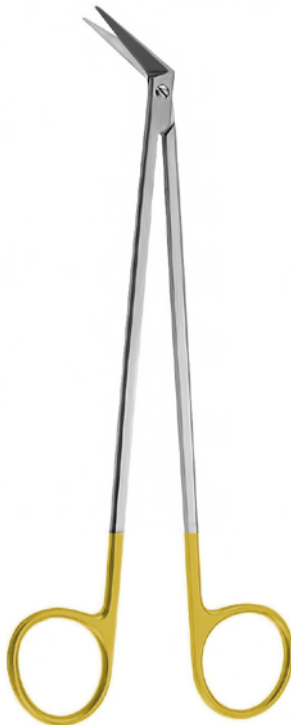

25°

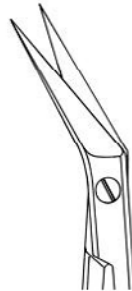

40°

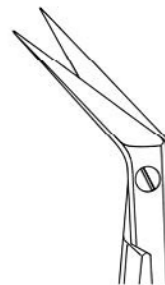

60°

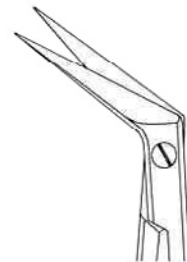

**POTTS-SMITH**

19.0 cm **GD03.484.25**

**GD03.484.40**

**GD03.484.60**

TC Cutting Edges  
TC-Schneiden  
Tranchant TC  
Filos de corte TC  
Taglio TC

Vascular Scissors  
Gefäß-Scheren  
Ciseaux vasculaires  
Tijeras vasculares  
Forbici vascolari



25°

DIETRICH

18.0 cm  
GD03.486.25

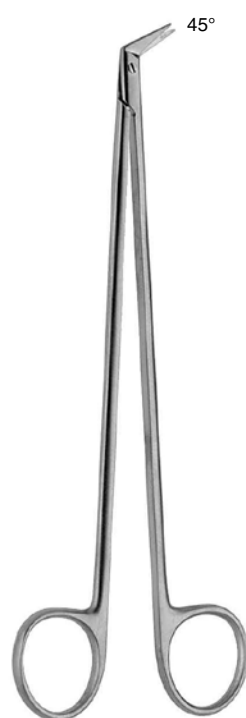

45°

DIETRICH

18.0 cm  
GD03.486.45



60°

DIETRICH

18.0 cm  
GD03.486.60



90°

DIETRICH

18.0 cm  
GD03.486.90



125°

DIETRICH

18.0 cm  
GD03.487.25



125°

DIETRICH

18.0 cm  
GD03.488.25



Vascular Scissors  
Gefäß-Scheren  
Ciseaux vasculaires  
Tijeras vasculares  
Forbici vascolari

**GRAND**  
DEVICES  
*The Grand Instruments Company*

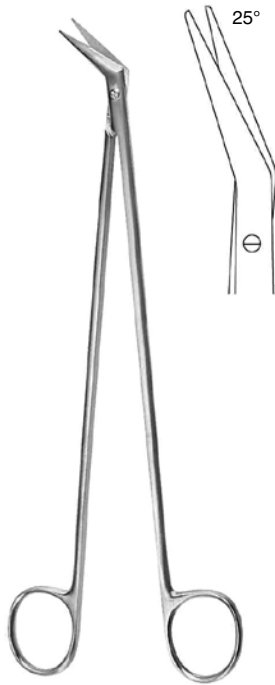

DE BAKEY

16.0 cm **GD03.490.16**  
23.0 cm **GD03.490.23**  
28.0 cm **GD03.490.28**

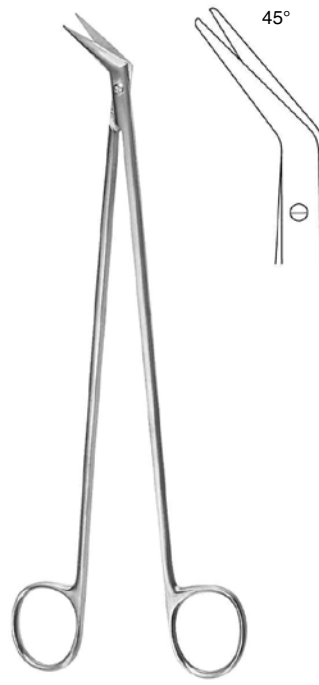

DE BAKEY

16.0 cm **GD03.491.16**  
23.0 cm **GD03.491.23**  
28.0 cm **GD03.491.28**

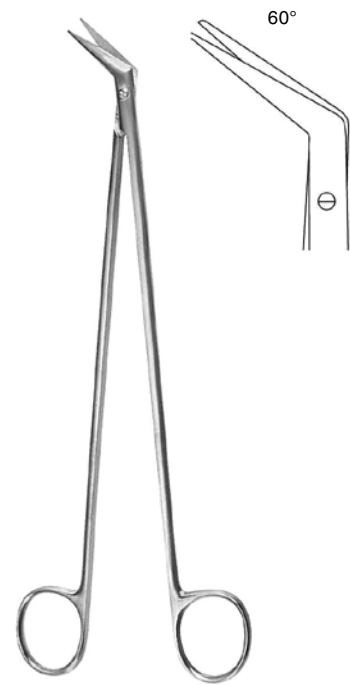

DE BAKEY

16.0 cm **GD03.492.16**  
23.0 cm **GD03.492.23**  
28.0 cm **GD03.492.28**



DE BAKEY

23.0 cm **GD03.493.23**

TC Cutting Edges  
TC-Schneiden  
Tranchant TC  
Filos de corte TC  
Taglio TC

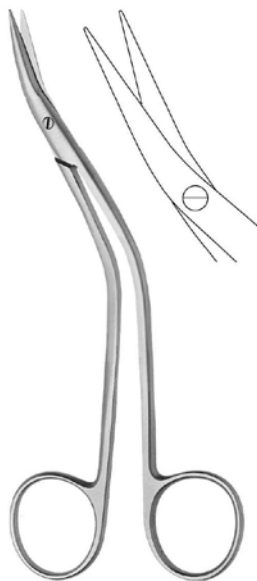

DE BAKEY

15.5 cm **GD03.495.15**

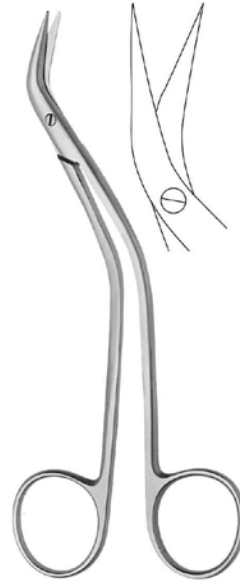

DE BAKEY

15.5 cm **GD03.497.15**



Parametrium

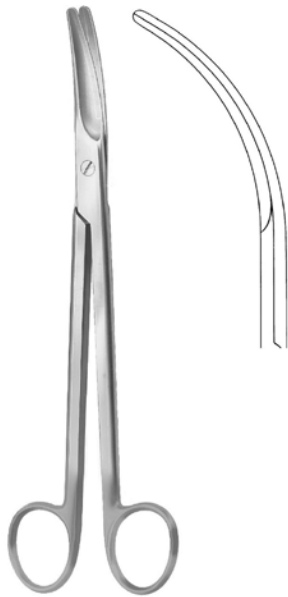

22.5 cm **GD03.501.22**



23.0 cm  
**GD03.501.23**



22.5 cm **GD03.505.22**



22.5 cm  
**GD03.505.23**

TC Cutting Edges  
TC-Schneiden  
Tranchant TC  
Filos de corte TC  
Taglio TC



Gynaecological Scissors  
Gynäkologische Scheren  
Ciseaux gynécologiques  
Tijeras ginecológicas  
Forbici ginecologiche

**GRAND**  
DEVICES  
*The Grand Instruments Company*



**SIMS**

20.0 cm  
**GD03.510.20**  
23.0 cm  
**GD03.510.23**



**SIMS**

20.0 cm **GD03.511.20**  
23.0 cm **GD03.511.23**



**SIMS**

23.0 cm  
**GD03.514.23**



**SIMS**

20.0 cm  
**GD03.515.20**  
23.0 cm  
**GD03.515.23**

TC Cutting Edges  
TC-Schneiden  
Tranchant TC  
Filos de corte TC  
Taglio TC



**SIEBOLD**

24.0 cm  
**GD03.523.24**



**WERTHEIM**

22.5 cm **GD03.525.22**



**WERTHEIM**

22.5 cm **GD03.527.22**

TC Cutting Edges  
TC-Schneiden  
Tranchant TC  
Filos de corte TC  
Taglio TC





**DOYEN**  
 18.0 cm  
**GD03.530.17**



**DOYEN**  
 18.0 cm  
**GD03.531.17**



**DUBOIS**  
 27.0 cm  
**GD03.536.27**



**DUBOIS**  
 27.0 cm  
**GD03.537.27**



**KELLY**  
 16.0 cm  
**GD03.540.16**  
 18.0 cm  
**GD03.540.18**



**KELLY**  
 16.0 cm **GD03.541.16**  
 18.0 cm **GD03.541.18**



Gynaecological Scissors  
Gynäkologische Scheren  
Ciseaux gynécologiques  
Tijeras ginecológicas  
Forbici ginecologiche

**GRAND**  
DEVICES  
The Grand Instruments Company

Umbilical Scissors  
Nabelschnur-Scheren  
Ciseaux ombilicaux  
Tijeras umbilicales  
Forbici ombelicali



**U.S.A Mod.**  
10.5 cm **GD03.550.10**



**BUSCH**  
16.0 cm **GD03.551.16**



**SCHUMACHER**  
14.0 cm **GD03.553.16**



**WALDMANN**  
18.0 cm  
**GD03.555.18**

Episiotomy  
Episiotomie  
Episiotomia  
Episiotomia  
Episiotomia



**BRAUN-STADLER**  
14.5 cm **GD03.560.14**  
20.0 cm **GD03.560.20**  
22.0 cm **GD03.560.22**

Nerve dissecting scissors  
Nerv-Präparierscheren  
Ciseaux pour nerfs  
Tijeras para nervios  
Forbici per nervi



11.0 cm **08.580.11**



11.0 cm **08.581.11**

Operating Scissors  
 Chirurgische Scheren  
 Ciseaux à chirurgie  
 Tijeras para cirugía  
 Forbici per chirurgia



Neurosurgery  
 Neurochirurgie  
 Neurocirurgia  
 Neurochirurgia



15.0 cm **GD03.582.15**

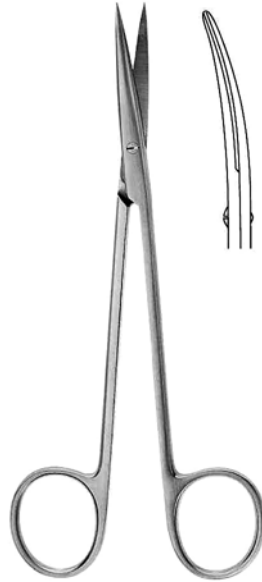

15.0 cm **GD03.583.15**

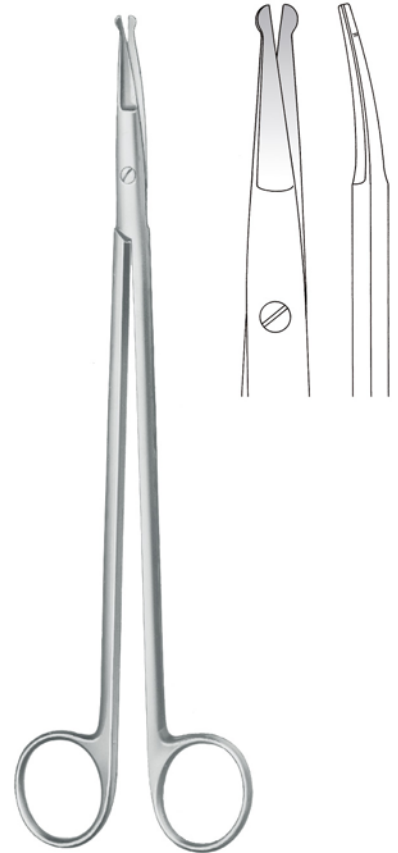

**STRULLY**  
 22.0 cm  
**GD03.601.22**



**TOENNIS-ADSON**  
 18.0 cm **GD03.610.18**

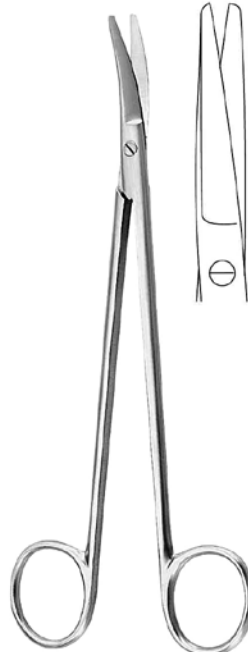

**TOENNIS-ADSON**  
 18.0 cm **GD03.611.18**

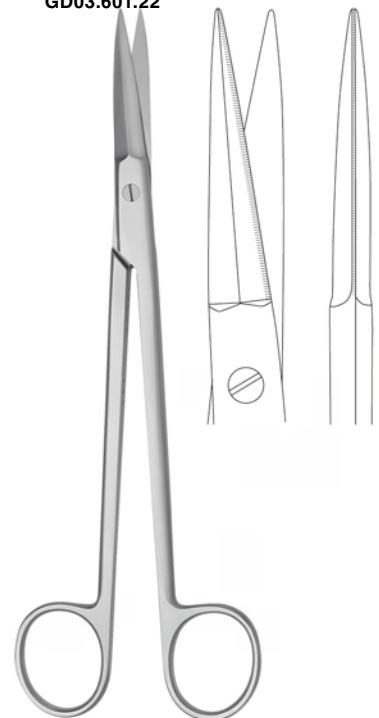

**MC INDOE**  
 19.0 cm **GD03.614.19**



Operating Scissors  
Chirurgische Scheren  
Ciseaux à chirurgie  
Tijeras para cirugía  
Forbici per chirurgia

**GRAND**<sup>®</sup>  
DEVICES  
*The Grand Instruments Company*

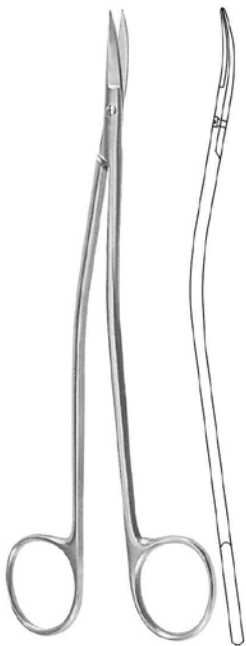

**DANDY**  
17.0 cm **GD03.617.17**

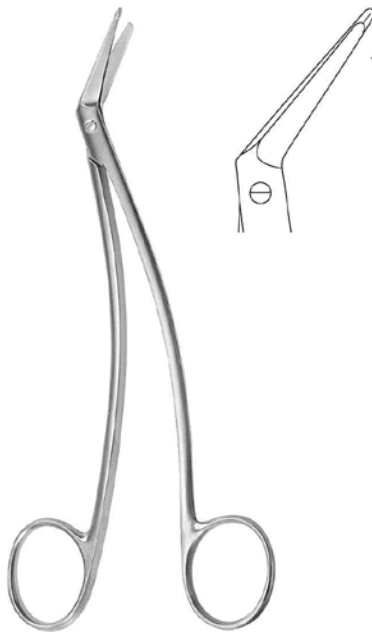

**SCHMIEDEN-TAYLOR**  
17.0 cm **GD03.619.17**



**CRAFOORD**  
30.0 cm **GD03.641.30**



**THOREK**  
19.0 cm **GD03.643.18**  
25.0 cm **GD03.643.25**



**SATINSKY**  
21.0 cm  
**GD03.650.21**



**SATINSKY**  
24.5 cm  
**GD03.651.24**

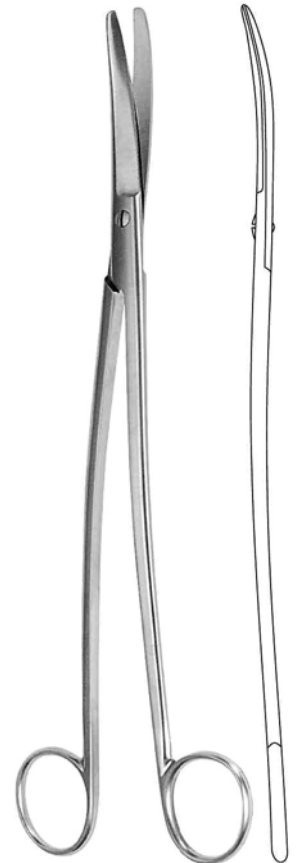

**KLINKENBERG-LOTH**  
23.0 cm **GD03.661.23**



Operating Scissors  
Chirurgische Scheren  
Ciseaux à chirurgie  
Tijeras para cirugía  
Forbici per chirurgia

**GRAND**  
DEVICES  
*The Grand Instruments Company*

Lobectomy and rectal scissors  
Lungenlappen- und Rektumscheren  
Ciseaux à lobectomie et pour le rectum  
Tijera para lobectomía y recto  
Forbici per lobo polmonare e per il retto



**FINOCHIETTO**

27.0 cm  
GD03.663.27



**STELZNER**

30.0 cm  
GD03.664.30



**STELZNER**

30.0 cm  
GD03.665.30



Enterotomy Scissors  
Darmscheren  
Ciseaux à entérotonomie  
Enterótomos  
Forbici per enterotomia



21.0 cm **GD03.770.21**



21.0 cm **GD03.772.21**



21.0 cm **GD03.774.21**





Operating Scissors  
Chirurgische Scheren  
Ciseaux à chirurgie  
Tijeras para cirugía  
Forbici per chirurgia

**GRAND**  
DEVICES  
The Grand Instruments Company

Stitch Scissors  
Ligaturscheren  
Ciseaux à ligatures  
Tijeras para puntas  
Forbici per legature



**SPENCER**

9.0 cm **GD03.802.09**  
11.0 cm **GD03.802.11**  
12.0 cm **GD03.802.12**  
15.0 cm **GD03.802.15**



**SHORTBENT**

9.0 cm  
**GD03.803.09**

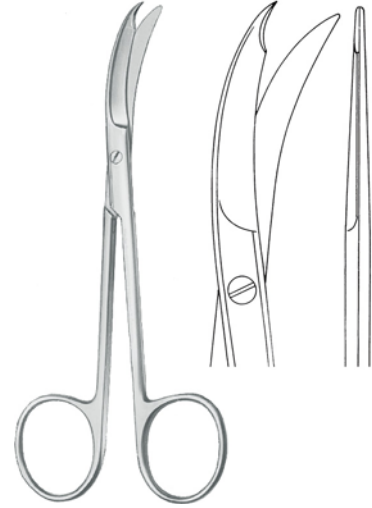

**NORTHBENT**

13.0 cm  
**GD03.803.13**

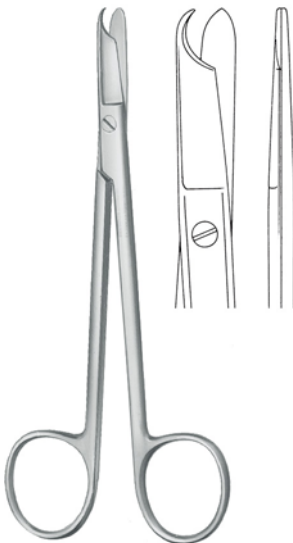

**LITTAUER**

14.0 cm **GD03.804.14**

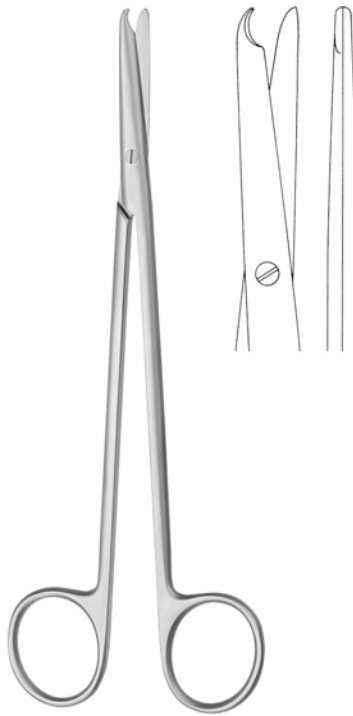

**BUCK**

14.5 cm **GD03.806.14**  
18.0 cm **GD03.806.18**

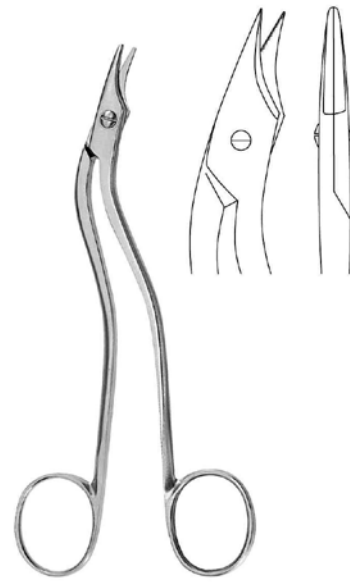

**HEATH**

15.0 cm  
**GD03.809.15**

Operating Scissors  
 Chirurgische Scheren  
 Ciseaux à chirurgie  
 Tijeras para cirugía  
 Forbici per chirurgia



Gum Scissors  
 Zahnfleischscheren  
 Ciseaux à gencives  
 Tijeras para encías  
 Forbici gengivali



11.5 cm **GD03.815.11**



**LAGRANGE**  
 11.5 cm **GD03.817.11**

serrated  
 gezahnt  
 dentelé  
 dentada  
 dentellate



**LAGRANGE**  
 11.5 cm **GD03.819.11**



**GOLDMANN-FOX**  
 13.0 cm **GD03.820.13**



**GOLDMANN-FOX**  
 13.0 cm  
**GD03.821.13**

serrated  
 gezahnt  
 dentelé  
 dentada  
 dentellate



**GOLDMANN-FOX**  
 13.0 cm  
**GD03.822.13**

TC Cutting Edges  
 TC-Schneiden  
 Tranchant TC  
 Filos de corte TC  
 Taglio TC



**GOLDMANN-FOX**  
 13.0 cm  
**GD03.823.13**



Operating Scissors  
Chirurgische Scheren  
Ciseaux à chirurgie  
Tijeras para cirugía  
Forbici per chirurgia

**GRAND**  
DEVICES  
*The Grand Instruments Company*

Gum Scissors  
Zahnfleischscheren  
Ciseaux à gencives  
Tijeras para encías  
Forbici gengivali



**WAGNER**  
12.0 cm **GD03.824.12**



**WAGNER**  
12.0 cm **GD03.825.12**

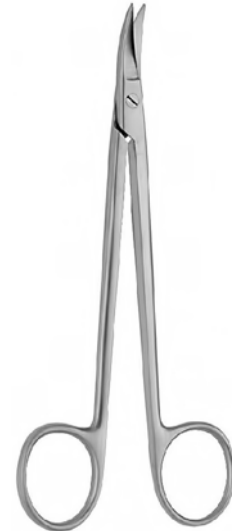

**QUINBY**  
12.0 cm **GD03.827.12**

Wire and plate shears  
Draht-, Blechscheren  
Ciseaux à fils et plaques métalliques  
Tijeras para alambre y chapas  
Forbice per filo metallo lamiera

TC Cutting Edges  
TC-Schneiden  
Tranchant TC  
Filos de corte TC  
Taglio TC



**UNIVERSAL**  
12.0 cm **GD03.831.12**

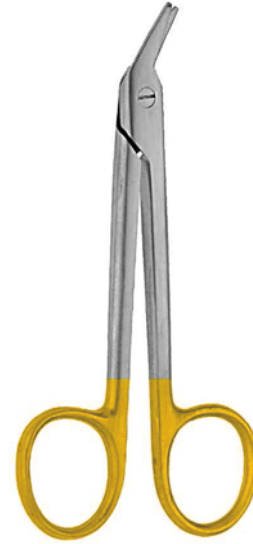

**UNIVERSAL**  
12.0 cm **GD03.835.12**

Operating Scissors  
Chirurgische Scheren  
Ciseaux à chirurgie  
Tijeras para cirugía  
Forbici per chirurgia



Wire and plate shears  
Draht- Blehscheren  
Ciseaux à fils et plaques métalliques  
Tijeras para alambre y chapas  
Forbice per filo metallo lamiera

straight  
gerade  
droites  
rectas  
rette



**BEEBE**  
10.5 cm  
**GD03.850.10**

pointed  
spitz  
pointus  
agudas  
acute



**BEEBE**  
10.5 cm **GD03.851.10**

curved  
gebogen  
courbes  
curvas  
curve

straight  
gerade  
droites  
rectas  
rette



**BEEBE**  
10.5 cm  
**GD03.852.10**

blunt  
stumpf  
mousses  
romas  
smusse



**BEEBE**  
10.5 cm  
**GD03.853.10**

curved  
gebogen  
courbes  
curvas  
curve

straight  
gerade  
droites  
rectas  
rette



**BEEBE**  
12.0 cm **GD03.854.12**

serrated  
gezahnt  
dentelé  
dentada  
dentellate



**BEEBE**  
12.0 cm **GD03.855.12**

curved  
gebogen  
courbes  
curvas  
curve



Operating Scissors  
Chirurgische Scheren  
Ciseaux à chirurgie  
Tijeras para cirugía  
Forbici per chirurgia

**GRAND**  
DEVICES  
*The Grand Instruments Company*

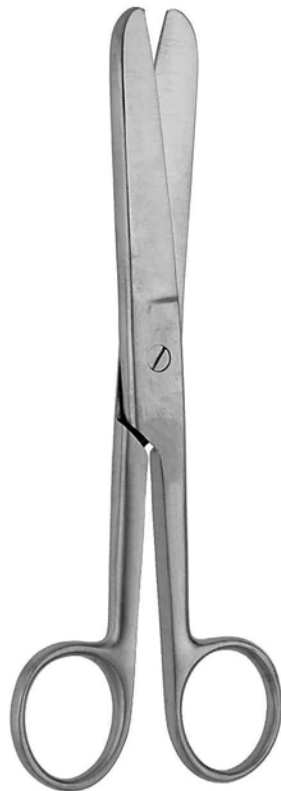

**LANGE**

18.0 cm  
**GD03.896.18**

Gauze  
Gaze  
Gaze  
Gaza  
Garza



**SMITH US ARMY**

15.0 cm **GD03.898.15**  
16.0 cm **GD03.898.16**  
18.0 cm **GD03.898.18**  
20.0 cm **GD03.898.20**  
23.0 cm **GD03.898.23**



TC Cutting Edges  
 TC-Schneiden  
 Tranchant TC  
 Filos de corte TC  
 Taglio TC



**LISTER**

- 09.5 cm **GD03.901.09**
- 11.0 cm **GD03.901.11**
- 14.0 cm **GD03.901.14**
- 14.0 cm **GD03.901.14L**
- 16.0 cm **GD03.901.16**
- 16.0 cm **GD03.901.16L**
- 18.0 cm **GD03.901.18**
- 18.0 cm **GD03.901.18L**
- 20.0 cm **GD03.901.20**
- 25.0 cm **GD03.901.25**
- 30.0 cm **GD03.901.30**



**LISTER**

- 14.0 cm **GD03.902.14**



**LISTER**

- 18.0 cm **GD03.903.18**
- 20.0 cm **GD03.903.20**



**LISTER**

- 14.0 cm **GD03.905.14**
- 18.0 cm **GD03.905.18**
- 20.0 cm **GD03.905.20**



Bandage Scissors  
Verband-Scheren  
Ciseaux à bandages  
Tijeras para vendajes  
Forbici per bendaggi

**GRAND**  
DEVICES  
*The Grand Instruments Company*

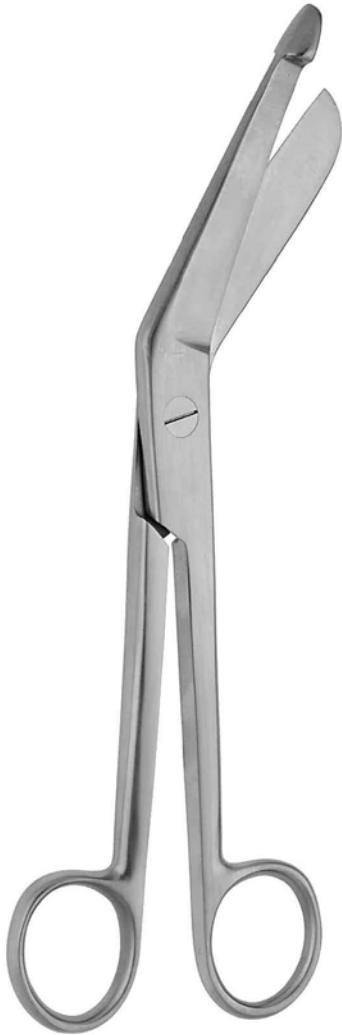

**BERGMANN**

23.0 cm **GD03.911.23**

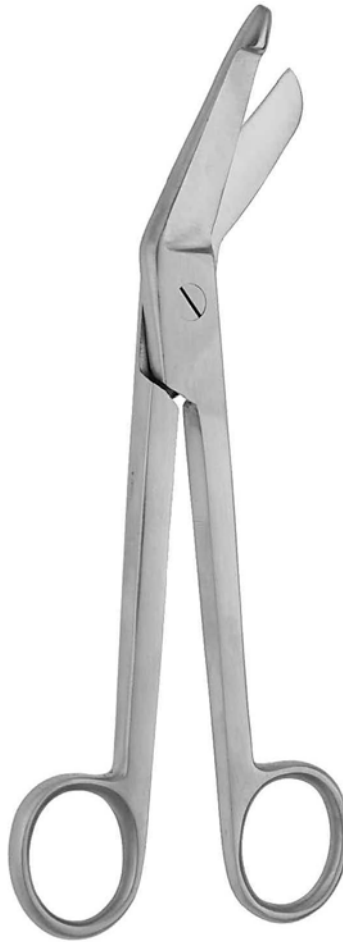

**ESMARCH**

20.0 cm **GD03.913.20**  
22.0 cm **GD03.913.22**



**DIMEDA**

16.0 cm **GD03.921.16**  
19.0 cm **GD03.921.19**





**ROTES KREUZ**  
17.0 cm **GD03.927.17**



**KNOWLES**  
14.0 cm **GD03.930.14**



**KNOWLES**  
14.0 cm **GD03.931.14**



**LORENZ**  
23.0 cm  
**GD03.933.23**



Bandage Scissors  
Verband-Scheren  
Ciseaux à bandages  
Tijeras para vendajes  
Forbici per bendaggi

**GRAND**  
DEVICES  
*The Grand Instruments Company*

one serrated cutting edge  
eine Schneide gezahnt  
une lame dentelé  
una hoja cortante dentada  
una lama dentada

TC Cutting Edges  
TC-Schneiden  
Tranchant TC  
Filos de corte TC  
Taglio TC



BRUNS

23.0 cm  
GD03.935.23



BRUNS

23.0 cm GD03.937.23



BRUNS

23.0 cm GD03.939.23

Bandage Scissors  
Verband-Scheren  
Ciseaux à bandages  
Tijeras para vendajes  
Forbici per bendaggi



Plaster Shear  
Gipsschere  
Ciseaux pour plâtre  
Tijera para yeso  
Forbice per gesso



20.0 cm  
**GD03.941.20**



**FERGUSSON**  
18.0 cm **GD03.942.18**

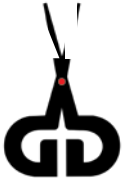

Bandage Scissors  
Verband-Scheren  
Ciseaux à bandages  
Tijeras para vendajes  
Forbici per bendaggi

**GRAND**  
DEVICES  
*The Grand Instruments Company*



14.5 cm **GD03.952.14**



**Universal**

	Black	Blue	Green	Red	Yellow	White
15.0 cm	<b>GD03.950.15</b>	<b>GD03.950.15B</b>	<b>GD03.950.15G</b>	<b>GD03.950.15R</b>	<b>GD03.950.15Y</b>	<b>GD03.950.15W</b>
18.0 cm	<b>GD03.950.18</b>	<b>GD03.950.18B</b>	<b>GD03.950.18G</b>	<b>GD03.950.18R</b>	<b>GD03.950.18Y</b>	<b>GD03.950.18W</b>

Micro Scissors  
Mikro Scheren  
Micro Ciseaux  
Micro Tijeras  
Micro Forbici  
微型剪刀

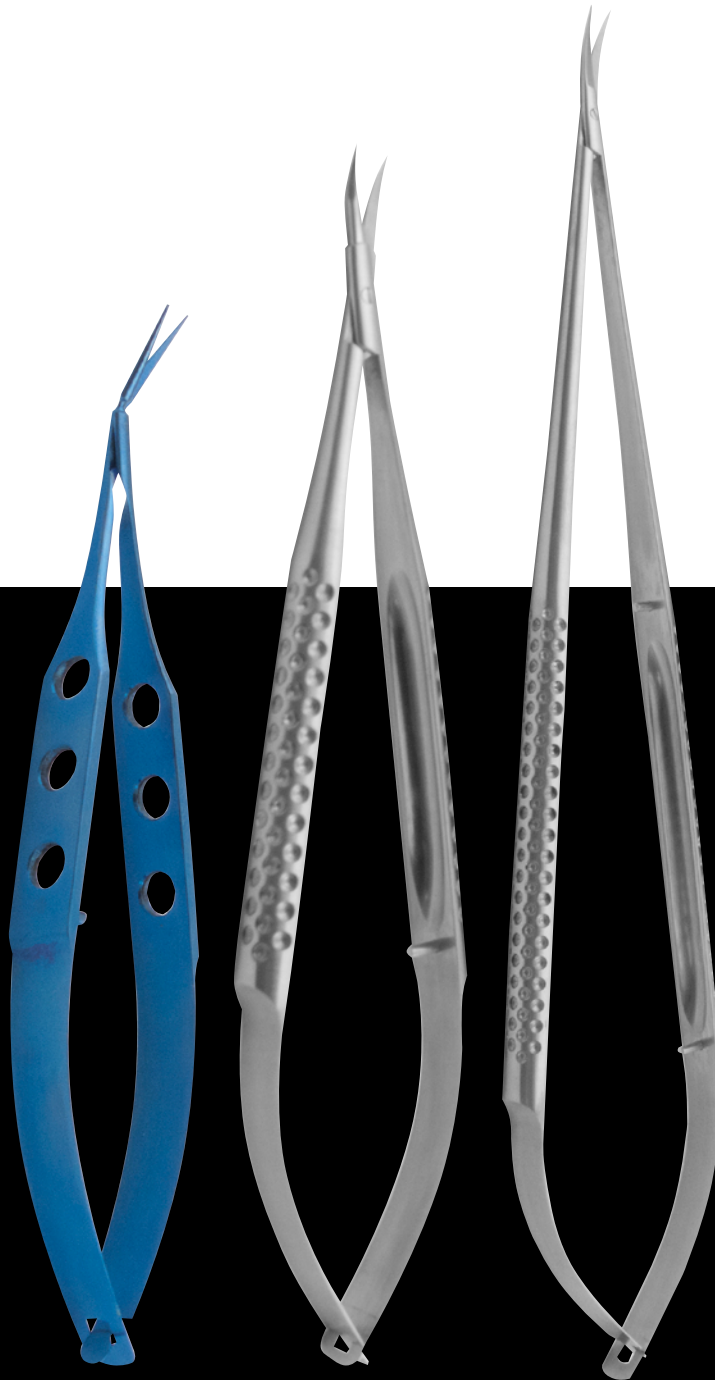

**G D O 4**



Ophthalmic Scissors  
Augen Scheren  
Ciseaux oculaires  
Tijeras oculares  
Forbici oculistiche

**GRAND**  
DEVICES  
The Grand Instruments Company

Tendon Scissors  
Sehnen-Scheren  
Ciseaux tendons  
Tijeras tendones  
Forbici tendini

Iridectomy Scissors Iridektomi-  
escheren  
Ciseaux à iridectomie  
Tijeras para iridectomia  
Forbici per iridectomia

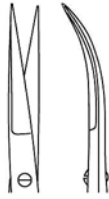

sharp  
spitz  
pointu  
agudo  
appuntato

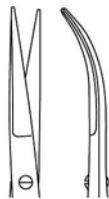

blunt  
stumpf  
mousse  
romo  
smusso



**WESTCOTT**  
11 cm **GD04.102.11**

**WESTCOTT**  
11 cm **GD04.104.11**

**WESTCOTT**  
11 cm **GD04.106.11**

**WESTCOTT**  
11 cm **GD04.107.11**



Tendon, Iris Scissors Sehnen-, Iris-Scheren Ciseaux à iris et tendons Tijeras iris y para tendones Forbici per iride e tendini



**NOYES**

13 cm **GD04.109.13**  
 16 cm **GD04.109.16**

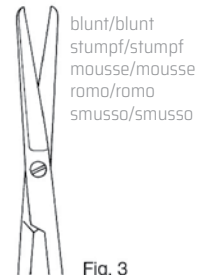
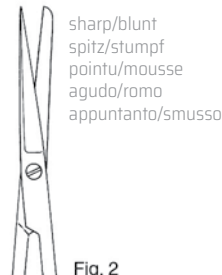
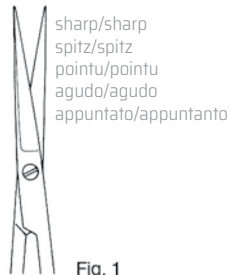

**NOYES**  
 12 cm **GD04.110.12**

**NOYES**  
 12 cm **GD04.111.12**

**NOYES**  
 12 cm **GD04.112.12**





Ophthalmic Scissors  
 Augen Scheren  
 Ciseaux oculaires  
 Tijeras oculares  
 Forbici oculistiche



Tendon, Iris Scissors  
 Sehnen-, Iris-Scheren  
 Ciseaux à iris et tendons Tijeras iris y para  
 tendones Forbici per iride e tendini



sharp  
 spitz  
 pointu  
 agudo  
 appuntato

**WECKER**  
 11 cm **GD04.113.11**

sharp/sharp  
 spitz/spitz  
 pointu/pointu  
 agudo/agudo  
 appuntato/appuntato



**NOYES**  
 12 cm **GD04.110.12**

sharp/blunt  
 spitz/stumpf  
 pointu/mousse  
 agudo/romo  
 appuntato/smusso



**NOYES**  
 12 cm **GD04.111.12**

blunt/blunt  
 stumpf/stumpf  
 mousse/mousse  
 romo/romo  
 smusso/smusso



**NOYES**  
 12 cm **GD04.112.12**



sharp  
 spitz  
 pointu  
 agudo  
 appuntato

**McPherson-Westcott**  
 11 cm **GD04.118.01**



blunt  
 stumpf  
 mousse  
 romo  
 smusso

**McPherson-Westcott**  
 11 cm **GD04.118.02**



length of blades 10 mm  
 Blattlänge 10 mm  
 longueur des lames 10 mm  
 largo de hojas 10 mm  
 lunghezza della lama 10 mm

**BARRAQUER**  
 5.5 cm **GD04.119.10**



Iridectomy, corneal  
 Iridektomie, Hornhaut  
 Iridectomie, cornéens  
 Iridectomía, corneal  
 Iridectomia, corneale



**McGUIRE**  
 10 cm **GD04.121.10**



sharp  
 spitz  
 pointu  
 agudo  
 appuntato

**CASTROVIEJO**  
 10 cm **GD04.133.10**



blunt  
 stumpf  
 mousse  
 romo  
 smusso

**CASTROVIEJO**  
 10 cm **GD04.135.10**



straight  
 gerade  
 droits  
 rectas  
 rette

**VANNAS**  
 8.0 cm **GD04.140.08**



curved gebogen  
 courbes  
 curvas  
 curve

**VANNAS**  
 8.0 cm **GD04.141.08**



angular kniegebogen  
 coudés  
 acodadas  
 angolate

**VANNAS**  
 8.0 cm **GD04.143.08**



Ophthalmic, Micro Scissors  
 Augen-, Mikro-Scheren  
 Ciseaux oculaires, micro-ciseaux  
 Tijeras oculares, microquirúrgicas  
 Forbici oculistiche, micro-chirurg.



Iridectomy, corneal  
 Iridektomie, Hornhaut  
 Iridectomie, cornéens  
 Iridectomia, corneal  
 Iridectomia, corneale



left  
 links  
 gauche  
 izquierda  
 sinistra

**CASTROVIEJO**  
 10 cm **GD04.147.10**



right  
 rechts  
 droite  
 derecha  
 destra

**CASTROVIEJO**  
 10 cm **GD04.149.10**



blunt stumpf  
 mousse  
 romo  
 smusso

**CASTROVIEJO**  
 11 cm **GD04.151.11**

Micro Surgery  
 Mikrochirurgie  
 Microchirurgie  
 Microcirugía  
 Microchirurgia



blunt  
 stumpf  
 mousse  
 romo  
 smusso

**CASTROVIEJO**  
 11 cm **GD04.153.11**



blunt  
 stumpf  
 mousse  
 romo  
 smusso

**CASTROVIEJO**  
 11 cm **GD04.155.11**



**CASTROVIEJO**  
 10 cm **GD04.157.10**

Ophthalmic, Micro Scissors  
 Augen-, Mikro-Scheren  
 Ciseaux oculaires, micro-ciseaux  
 Tijeras oculares, microquirúrgicas  
 Forbici oculistiche, micro-chirurg.



left  
 links  
 gauche  
 izquierda  
 sinistra

**TROUTMAN-CASTROVIEJO**

11 cm **GD04.161.11**



right  
 rechts  
 droite  
 derecha  
 destra

**TROUTMAN-CASTROVIEJO**

11 cm **GD04.163.11**



straight  
 gerade  
 droits  
 rectas  
 rette

14 cm **GD04.202.14**  
 18 cm **GD04.202.18**



curved geb-  
 ogen  
 courbes  
 curvas  
 curve

14 cm **GD04.203.14**  
 18 cm **GD04.203.18**



straight  
 gerade  
 droits  
 rectas  
 rette

18 cm **GD04.204.18**



curved geb-  
 ogen  
 courbes  
 curvas  
 curve

18 cm **GD04.205.18**



Ophthalmic, Micro Scissors  
Augen-, Mikro-Scheren  
Ciseaux oculaires, micro-ciseaux  
Tijeras oculares, microquirúrgicas  
Forbici oculistiche, micro-chirurg.

**GRAND**  
DEVICES  
*The Grand Instruments Company*

sharp  
spitz  
pointu  
agudo  
appuntato



14.5 cm **GD04.220.14**  
18.0 cm **GD04.220.18**  
23.0 cm **GD04.220.23**

sharp  
spitz  
pointu  
agudo  
appuntato



14.5 cm **GD04.221.14**  
18.0 cm **GD04.221.18**  
23.0 cm **GD04.221.23**

blunt  
stumpf  
mousse  
romo  
smusso



14.5 cm **GD04.223.14**  
18.0 cm **GD04.223.18**

Ophthalmic, Micro Scissors  
 Augen-, Mikro-Scheren  
 Ciseaux oculaires, micro-ciseaux  
 Tijeras oculares, microquirúrgicas  
 Forbici oculistiche, micro-chirurg

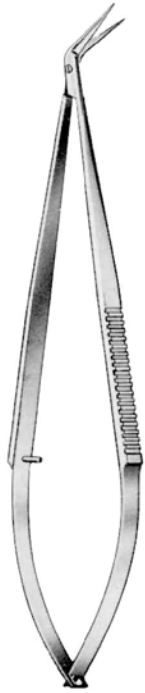

**GD04.224.25**  
 25°  
 18 cm



**GD04.224.45**  
 45°  
 18 cm



**GD04.224.60**  
 60°  
 18 cm



**GD04.224.90**  
 90°  
 18 cm

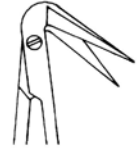

**GD04.225.00**  
 125°  
 18 cm

sharp  
 spitz  
 pointu  
 agudo  
 appuntato

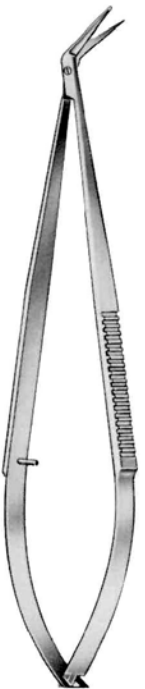

**GD04.225.25**  
 25°  
 18 cm



**GD04.225.45**  
 45°  
 18 cm



**GD04.225.60**  
 60°  
 18 cm



**GD04.225.90**  
 90°  
 18 cm

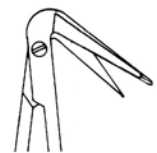

**GD04.226.00**  
 125°  
 18 cm

1 probe-pointed blade  
 1 Blatt geknüpft  
 1 lame boutonnée  
 1 hoja botonada  
 1 lama bottonnta



Ophthalmic, Micro Scissors  
 Augen-, Mikro-Scheren  
 Ciseaux oculaires, micro-ciseaux  
 Tijeras oculares, microquirúrgicas  
 Forbici oculistiche, micro-chirurg.

**GRAND**  
 DEVICES  
 The Grand Instruments Company

upwards curved  
 aufgebogen  
 courbe vers le haut  
 curvada hacia arriba  
 curvato verso l'alto

upwards curved  
 abwärts gebogen  
 courbe en bas  
 curvada hacia abajo  
 curvato verso il basso



straight  
 gerade  
 droits  
 rectas  
 rette

**YASARGIL**

16.5 cm **GD04.250.16**  
 20.0 cm **GD04.250.20**  
 22.5 cm **GD04.250.22**

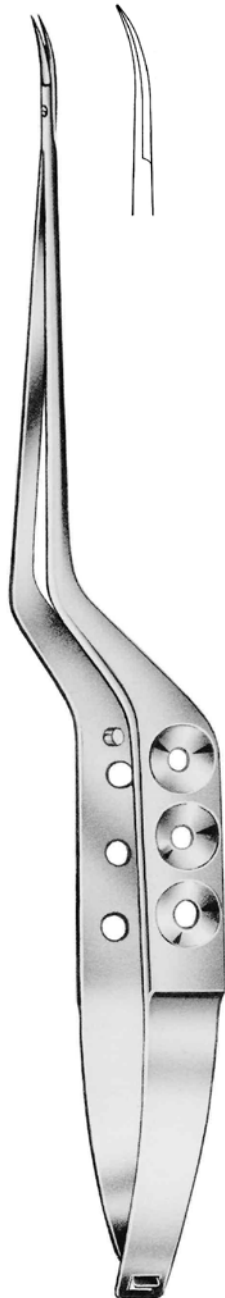

**YASARGIL**

16.5 cm **GD04.251.16**  
 20.0 cm **GD04.251.20**  
 22.5 cm **GD04.251.22**  
 24.5 cm **GD04.251.24**

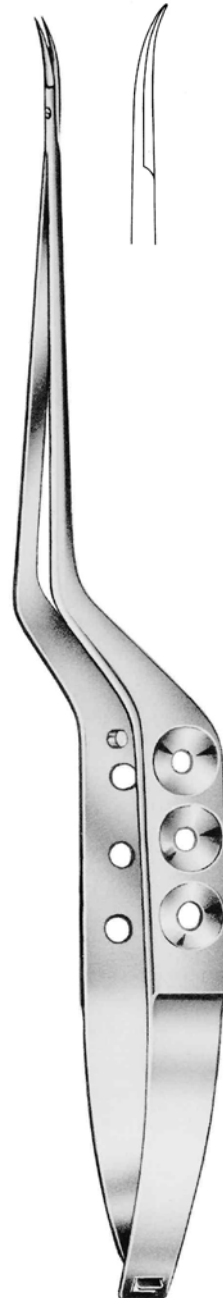

**YASARGIL**

20.0 cm **GD04.253.20**  
 22.5 cm **GD04.253.20**

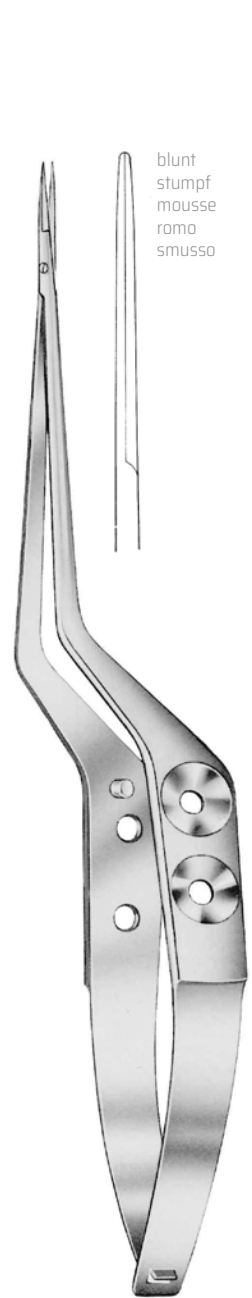

blunt  
 stumpf  
 mousse  
 romo  
 smusso

**YASARGIL**

20.0 cm **GD04.254.20**  
 22.5 cm **GD04.254.22**

Ophthalmic, Micro Scissors  
 Augen-, Mikro-Scheren  
 Ciseaux oculaires, micro-ciseaux  
 Tijeras oculares, microquirúrgicas  
 Forbici oculistiche, micro-chirurg.

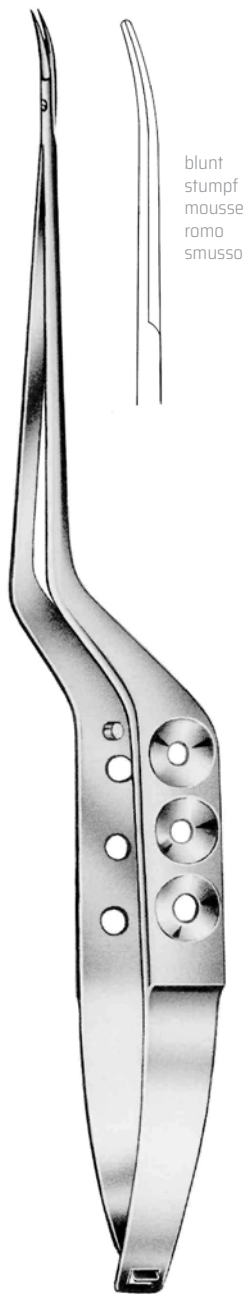

blunt  
 stumpf  
 mousse  
 romo  
 smusso

**YASARGIL**

20.0 cm **GD04.255.20**  
 22.5 cm **GD04.255.22**



curved geb-  
 ogen  
 courbes  
 curvas  
 curve

**JACOBSON**

19.0 cm **GD04.257.19**

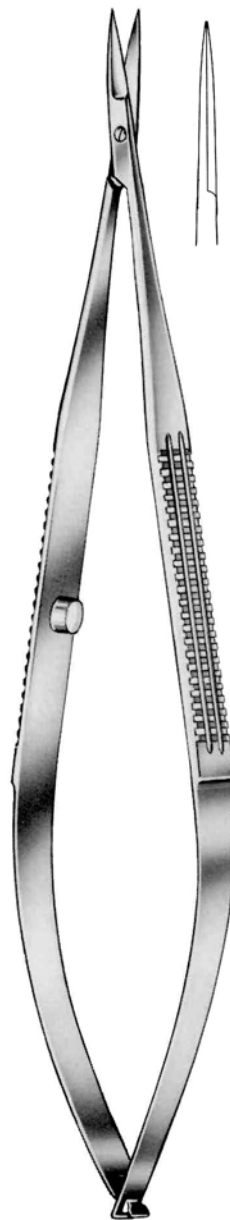

straight  
 gerade  
 droits  
 rectas  
 rette

**YASARGIL**

12.0 cm **GD04.260.12**  
 16.0 cm **GD04.260.16**  
 18.0 cm **GD04.260.18**

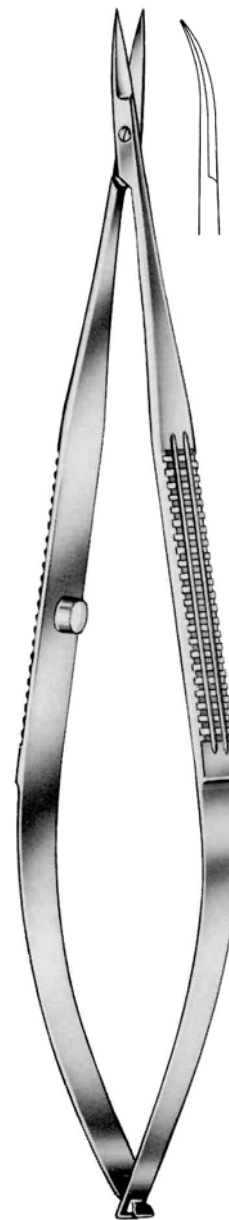

curved geb-  
 ogen  
 courbes  
 curvas  
 curve

**YASARGIL**

12.0 cm **GD04.261.12**  
 16.0 cm **GD04.261.16**  
 18.0 cm **GD04.261.18**





Ophthalmic, Micro Scissors  
Augen-, Mikro-Scheren  
Ciseaux oculaires, micro-ciseaux  
Tijeras oculares, microquirúrgicas  
Forbici oculistiche, micro-chirurg.

**GRAND**  
DEVICES  
*The Grand Instruments Company*

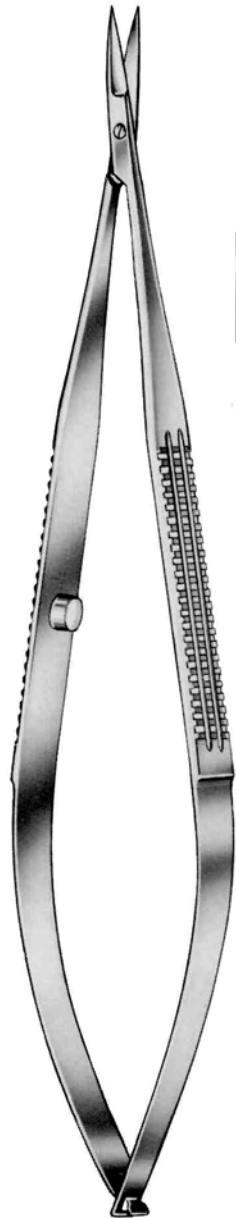

straight  
gerade  
droits  
rectas  
rette



**VANNAS**

12.0 cm **GD04.262.12**  
16.0 cm **GD04.262.16**

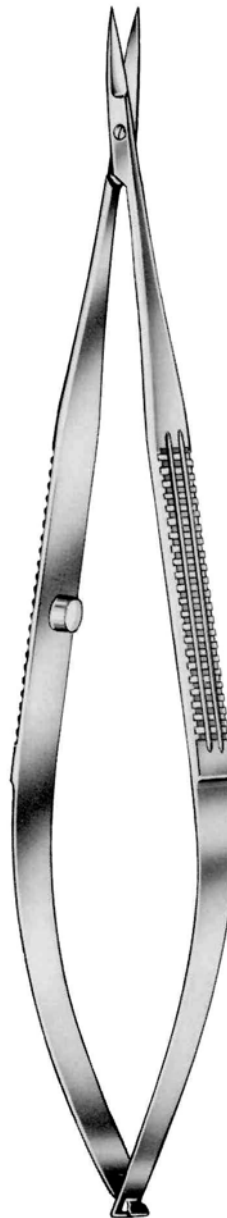

curved geb-  
ogen  
courbes  
curvas  
curve



**VANNAS**

12.0 cm **GD04.263.12**  
16.0 cm **GD04.263.16**

Ophthalmic, Micro Scissors  
 Augen-, Mikro-Scheren  
 Ciseaux oculaires, micro-ciseaux  
 Tijeras oculares, microquirúrgicas  
 Forbici oculistiche, micro-chirurg.



straight  
 gerade  
 droits  
 rectas  
 rette



18.5 cm **GD04.266.18**

curved geb-  
 ogen  
 courbes  
 curvas  
 curve



18.5 cm **GD04.267.18**

straight  
 gerade  
 droits  
 rectas  
 rette



**VANNAS**  
 18.5 cm **GD04.268.18**

curved geb-  
 ogen  
 courbes  
 curvas  
 curve



**VANNAS**  
 18.5 cm **GD04.269.18**



Suction Tubes  
Sauger  
Tubes d'aspiration  
Tubos de aspiración  
Tubi d'aspirazione  
吸管



**GD05**



Suction Tubes  
Sauger  
Tubes d'aspiration  
Tubos de aspiración  
Tubi d'aspirazione

**GRAND**  
DEVICES  
The Grand Instruments Company

**GD05.150.98**

Suction Tip  
Saugspitze  
Pointe de succion  
Cabezal para aspiración  
Punta per aspirazione



**POOLE**

ø 10 mm (30 Charr.)

**GD05.130.10**



**POOLE**

ø 6 mm (18 Charr.)  
ø 8 mm (23 Charr.)

**GD05.140.06**  
**GD05.140.08**

complete with suction tip and  
connector

komplett mit Saugspitze und  
Schlaucholive

complet avec pointe de succion et  
raccord

completo con punta de succión y  
conector

completi con punte d'aspirazione  
e raccordo



**GD05.150.99**

Olive  
Schlaucholive  
Olive  
Oliva  
Oliva

**YANKAUER**

27.0 cm **GD05.150.27**



**ANDREW-PYNCHON**  
ø 6 mm (18 Charr.) 23 cm

**GD05.153.24**

with stopcock and tube  
to be screwed off

mit Absperrventil und  
abschraubbarem Rohr

avec robinet et canule  
extérieure démontable

con interruptor y tubo  
desenroscable

con interruttore e tubo  
svitabile

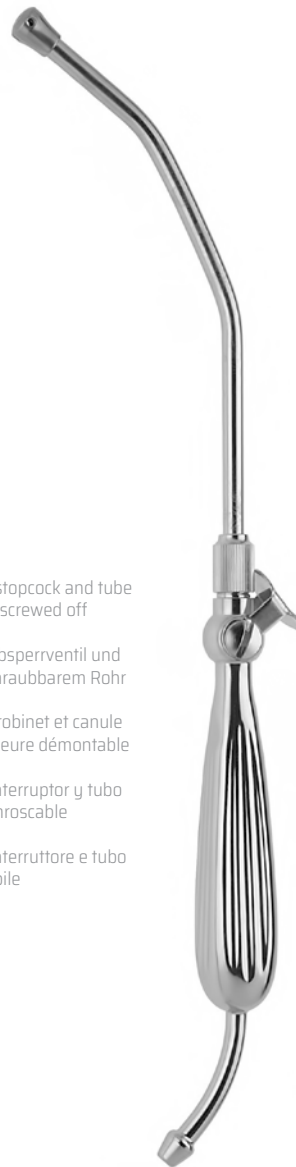

**WALTON YANKAUER**  
ø 10 mm (30 Charr.) 32 cm

**GD05.152.33**



Suction Tubes  
Sauger  
Tubes d'aspiration  
Tubos de aspiración  
Tubi d'aspirazione

**GRAND**  
DEVICES  
*The Grand Instruments Company*

Suction Tip  $\varnothing$  5 mm  
Saugspitze  $\varnothing$  5 mm  
Pointe de suction  $\varnothing$  5 mm  
Cabezal para aspiración  $\varnothing$  5 mm  
Punta per aspirazione  $\varnothing$  5 mm



**DE BAKEY**  
28.0 cm **GD05.154.27**



**DE BAKEY**  
16.0 cm **GD05.154.16**  
26.0 cm **GD05.154.26**

Suction Cannula with finger cut-off and stylet  
Saugkanülen mit Unterbrecher und Mandrin  
Canules d'aspiration avec interrupteur à doigt  
Cánulas para aspiración con interruptor y estilete  
Cannule per aspirazione con interruttore e stiletto



**GD05.155.99**  
Stylet  
Mandrin  
Doigt  
Esfilete  
Stiletto

**MAGILL**  
24.5 cm Fig. 1,  $\varnothing$  3,0 mm **GD05.155.30**  
24.5 cm Fig. 2,  $\varnothing$  3,5 mm **GD05.155.35**  
24.5 cm Fig. 3,  $\varnothing$  4,0 mm **GD05.155.40**

Suction Tubes  
 Sauger  
 Tubes d'aspiration  
 Tubos de aspiración  
 Tubi d'aspirazione



round opening  
 runde Öffnung  
 ouverture ronde  
 abertura redonda  
 apertura retonda

oval opening  
 ovale Öffnung  
 ouverture ovale  
 abertura ovalada  
 apertura ovale

ø 6 mm

ø 6 mm



**FINSTERER**  
 32.0 cm **GD05.158.00**



**NUBOER**  
 21.0 cm **GD05.160.21**



**NUBOER**  
 21.0 cm **GD05.161.21**

Suction and Irrigation Cannula  
 Saug- und Spülkanüle  
 Canules d'aspiration et d'irrigation  
 Cánulas para aspiración e irrigación  
 Cannule per aspirazione e irrigazione





**Catheter Introduction Forceps**  
**Kathetereinführzangen**  
**Pinces pour introduire les sondes**  
**Pinzas para catéteres**  
**Pinze per introdurre le sonde**



Suction Cannula with finger cut-off and stylet  
 Saugkanülen mit Unterbrecher und Mandrin  
 Canules d'aspiration avec interrupteur à doigt  
 Cánulas para aspiración con interruptor y estilete  
 Cannule per aspirazione con interruttore e stiletto

F.G. Charr.	Ø mm	30°	75°
6	2.0 mm	<b>GD05.295.06</b>	<b>GD05.297.06</b>
7	2.3 mm	<b>GD05.295.07</b>	<b>GD05.297.07</b>
8	2.7 mm	<b>GD05.295.08</b>	<b>GD05.297.08</b>
9	3.0 mm	<b>GD05.295.09</b>	<b>GD05.297.09</b>
10	3.3 mm	<b>GD05.295.10</b>	<b>GD05.297.10</b>
11	3.7 mm	<b>GD05.295.11</b>	<b>GD05.297.11</b>
12	4.0 mm	<b>GD05.295.12</b>	<b>GD05.297.12</b>
15	5.0 mm	<b>GD05.295.15</b>	<b>GD05.297.15</b>



**ADSON**  
 21.0 cm / 8¼" ø 4 mm **GD05.290.21**

**FRAZIER**  
 19.0 cm / 7½"



**MAGILL**  
 17.0 cm **GD05.190.17**  
 20.0 cm **GD05.190.20**  
 25.0 cm **GD05.190.25**



**GD05.190.17**  
 for babies  
 für Kleinkinder  
 pour nourrissons  
 para neonatales  
 per neonati



**GD05.190.20**  
 for children  
 für Kinder  
 pour enfants  
 para niños  
 per bambini

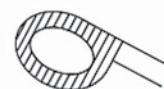

**GD05.190.25**  
 for adults  
 für Erwachsene  
 pour adultes  
 para adultos  
 per adulti

Thumb and Tissue Forceps

Pinzetten

Pinces à dissection

Pinzas de disección

Pinze per dissezione

拇指和组织钳



**GD**06-07



Thumb and Tissue Forceps  
 Pinzetten  
 Pincés à dissection  
 Pinzas de disección  
 Pinze per dissezione



narrow  
 schmal  
 étroite  
 estrecha  
 stretta



- 11.5 cm GD06.102.11
- 12.0 cm
- 13.0 cm GD06.102.13
- 14.5 cm GD06.102.14
- 15.0 cm
- 15.5 cm
- 16.0 cm GD06.102.16
- 18.0 cm GD06.102.18
- 20.0 cm GD06.102.20
- 21.0 cm
- 25.0 cm GD06.102.25
- 30.0 cm GD06.102.30

- USA
- GD06.104.12
  - GD06.104.13
  - GD06.104.14
  - GD06.104.15
  - GD06.104.18
  - GD06.104.21
  - GD06.104.25

- STILLE
- GD06.106.13
  - GD06.100.14
  - GD06.106.15
  - GD06.106.20

- GD06.110.11
- GD06.110.13
- GD06.110.14 GD06.114.14
- GD06.110.16 GD06.114.16
- GD06.110.18
- GD06.110.20
- GD06.110.25
- GD06.110.30

- POTTS-SMITH POTTS-SMITH
- GD06.112.18 GD06.116.18 GD06.126.18
  - GD06.112.21 GD06.116.21 GD06.126.21
  - GD06.112.25 GD06.116.25 GD06.126.25
  - GD06.112.30



1:2



1:2



narrow  
 schmal  
 étroite  
 estrecha  
 stretta

1:2



1:2



2:3



3:4



4:5

- 11.5 cm GD06.120.11
- 12.0 cm
- 13.0 cm GD06.120.13
- 14.5 cm GD06.120.14
- 15.0 cm
- 15.5 cm
- 16.0 cm GD06.120.16
- 18.0 cm GD06.120.18
- 20.0 cm GD06.120.20
- 21.0 cm
- 25.0 cm GD06.120.25
- 30.0 cm GD06.120.30

- USA
- GD06.122.12
  - GD06.122.13
  - GD06.122.14
  - GD06.122.15
  - GD06.122.18
  - GD06.122.21
  - GD06.122.25

- STILLE
- GD06.124.15
  - GD06.124.21

- GD06.130.11
- GD06.130.13
- GD06.134.14
- GD06.130.16
- GD06.130.18
- GD06.130.20
- GD06.130.25
- GD06.130.30
- GD06.140.11
- GD06.140.13
- GD06.140.14
- GD06.140.16
- GD06.140.18
- GD06.140.20
- GD06.140.25

- GD06.150.13
- GD06.150.14
- GD06.150.16
- GD06.150.20
- GD06.160.13
- GD06.160.14
- GD06.160.16
- GD06.160.20

Thumb and Tissue Forceps  
 Pinzetten  
 Pincès à dissection  
 Pinzas de disección  
 Pinze per dissezione

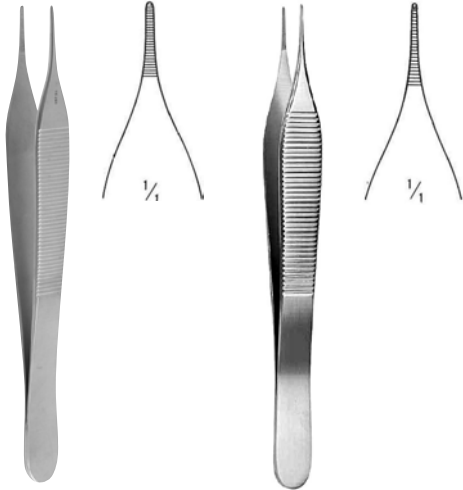

ADSON

12.0 cm **GD06.170.12**  
 12.0 cm **GD06.174.12**  
 15.0 cm **GD06.170.15**  
 15.0 cm **GD06.174.15**

ADSON micro

12.0 cm **GD06.176.12**  
 15.0 cm **GD06.176.15**



cushing

17.0 cm **GD06.220.17**  
**GD06.224.17**

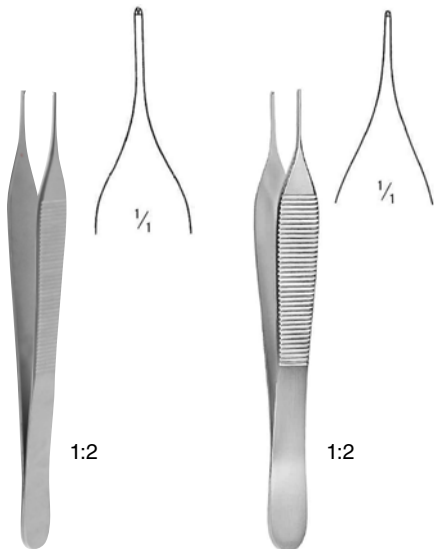

ADSON

10.0 cm  
 12.0 cm **GD06.180.12**  
 15.0 cm **GD06.180.15**  
 16.0 cm  
 20.0 cm  
 25.0 cm

ADSON micro

**GD06.186.12**  
**GD06.186.15**



ADSON-BROWN

7:7 **GD06.188.12**



BROWN

9:9 **GD06.189.12**



GRAEFE  
**D06.190.10**

**GD06.189.16**  
**GD06.189.20**  
**GD06.189.25**



cushing

17.0 cm  
**GD06.230.17**



Thumb and Tissue Forceps  
 Pinzetten  
 Pincas à dissection  
 Pinzas de disección  
 Pinze per dissezione

**GRAND**  
 DEVICES  
 The Grand Instruments Company

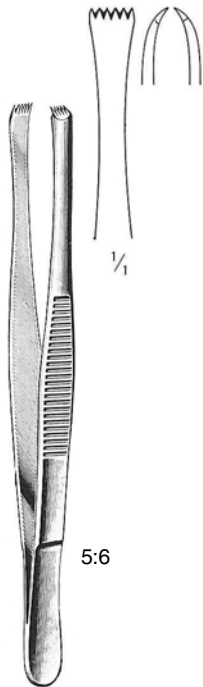

5:6

**LERICHE**

14.5 cm  
 15.0 cm **GD06.232.15**  
 18.0 cm  
 20.0 cm



4:5

**ADLERKREUTZ**

**GD06.236.15**  
**GD06.236.20**



1:2

**LANE**

**GD06.240.14**  
**GD06.240.18**  
**GD06.240.20**



2:3

**LANE**

**GD06.242.14**  
**GD06.242.18**



**FERRIS-SMITH**

**GD06.2GD06.18**



**FERRIS-SMITH**

**GD06.248.18**



**DUVAL**

14.5 cm **GD06.250.14**  
 15.0 cm  
 20.0 cm  
 25.0 cm

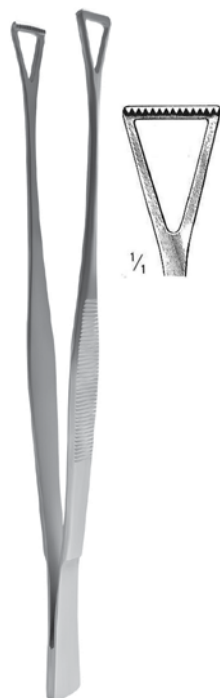

**COLLIN-DUVAL**

**GD06.252.14**



**RUSS. MOD.**

**GD06.256.15**  
**GD06.256.18**  
**GD06.256.25**



**McINDOE**

**GD06.258.15**

Thumb and Tissue Forceps  
 Pinzetten  
 Pincés à dissection  
 Pinzas de disección  
 Pinze per dissezione

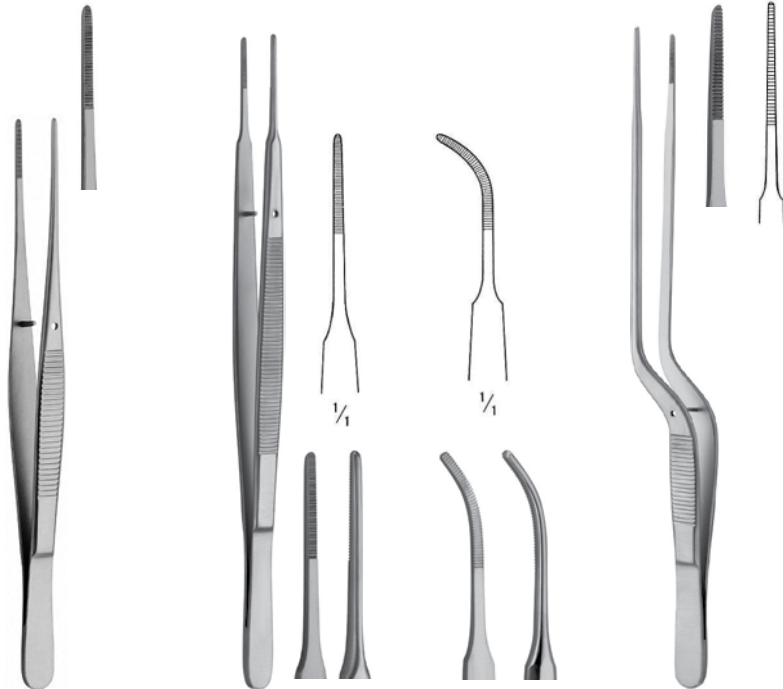

<b>SEMKEN</b>	<b>GERALD</b>	<b>GERALD</b>	<b>GERALD</b>
12.5 cm <b>GD06.260.12</b>			
15.5 cm <b>GD06.260.15</b>			
18.0 cm	<b>GD06.302.18</b>	<b>GD06.303.18</b>	<b>GD06.305.18</b>



<b>SEMKEN</b>	<b>GILLIES</b>	<b>GERALD</b>	<b>GERALD</b>	<b>SINGLEY</b>	<b>NELSON</b>	<b>WANGENSTEEN</b>
12.5 cm <b>GD06.270.12</b>						
15.5 cm <b>GD06.270.15</b>	<b>GD06.272.15</b>					
18.0 cm		<b>GD06.311.18</b>	<b>GD06.313.18</b>	<b>GD06.313.18</b>	<b>GD06.322.15</b>	<b>GD06.322.18</b>
23.0 cm		<b>GD06.311.23</b>		<b>GD06.320.18</b>	<b>GD06.322.23</b>	<b>GD06.324.23</b>



Splinter Forceps  
 Splitterpinzetten, -zangen  
 Pincès à échardes  
 Pinzas para espinas  
 Pinze per schegge

**GRAND**  
 DEVICES  
 The Grand Instruments Company



SPLINTER



feilchenfeld



HUNTER

HUNTER



WATCH MAKER

12.0 cm  
**GD06.330.12**  
 Fig. 3



12.0 cm  
**GD06.331.12**  
 Fig. 7



SPLINTER



CARMALT



CARMALT

07.5 cm		<b>GD06.810.07</b>					
09.5 cm	<b>GD06.802.09</b>	<b>GD06.810.09</b>					
10.5 cm	<b>GD06.802.10</b>		<b>GD06.812.10</b>	<b>GD06.813.10</b>		<b>GD06.816.10</b>	<b>GD06.817.10</b>
11.5 cm	<b>GD06.802.11</b>	<b>GD06.810.11</b>					
12.5 cm					<b>GD06.815.12</b>		



PEET  
 11.5 cm  
**GD06.821.11**



Peitz  
**GD06.822.13** 13.5 cm  
**GD06.823.13**

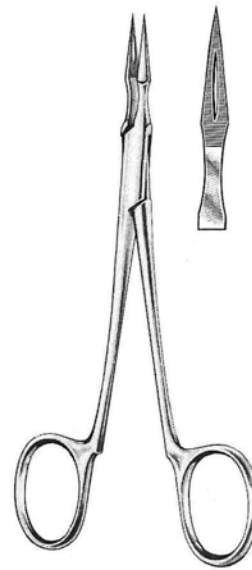

Peier  
**GD06.824.14** 14.0 cm  
**GD06.825.14**



virtus (Peier)  
 15.0 cm  
**GD06.828.15**



Microsurgery Forceps  
Mikrochirurgie-Pinzetten  
Pinces à microchirurgie  
Pinzas para microcirugía  
Pinze per microchirurgia



GD07.102.12 12.0 cm GD07.103.12



GD07.104.15 15.0 cm GD07.105.15



GD07.108.18 18.0 cm GD07.109.18  
GD07.108.23 23.0 cm





Atraumatic Tissue Forceps  
 Atraumatische Pinzetten  
 Pinces atrumatiques  
 Pinzas atraumáticas  
 Pinze atraumatiche

**GRAND**  
 DEVICES  
 The Grand Instruments Company

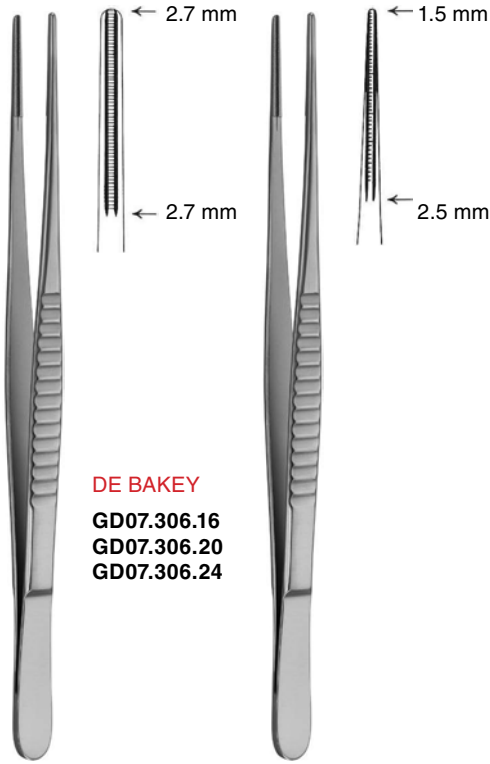

**DE BAKEY**

16.0 cm **GD07.304.16**  
 20.0 cm **GD07.304.20**  
 24.0 cm **GD07.304.24**  
 30.0 cm **GD07.304.30**

**DE BAKEY**

**GD07.306.16**  
**GD07.306.20**  
**GD07.306.24**

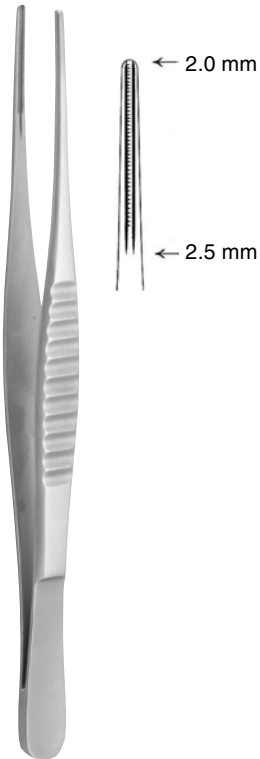

**DE BAKEY**

16.0 cm **GD07.308.16**  
 20.0 cm **GD07.308.20**  
 24.0 cm **GD07.308.24**  
 30.0 cm **GD07.308.30**

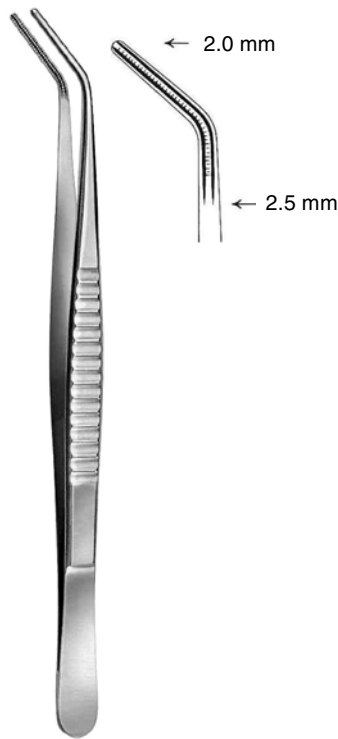

**DE BAKEY**

**GD07.309.16**  
**GD07.309.20**  
**GD07.309.24**  
**GD07.309.30**

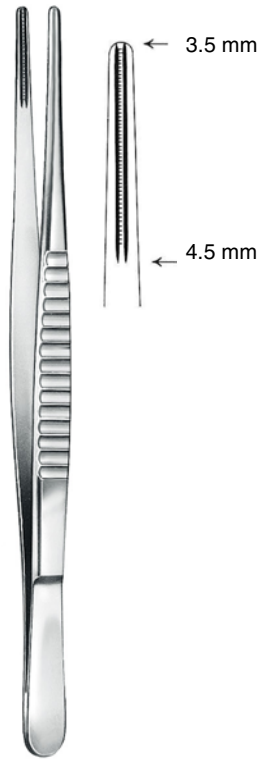

**DE BAKEY**

**GD07.310.16**  
**GD07.310.20**  
**GD07.310.24**  
**GD07.310.30**

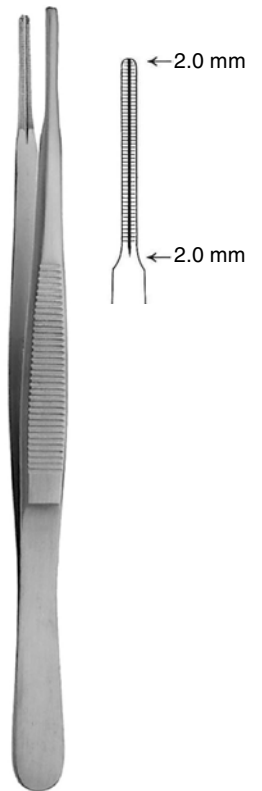

**COOLEY**

**GD07.314.16**  
**GD07.314.20**  
**GD07.314.24**

Polypus and Dressing Forceps  
Tupfer-Kornzangen  
Pinces à pansements et à polypes  
Pinzas para pólipos y esponjas  
Pinze per polipi e per tamponi  
息肉和敷料钳

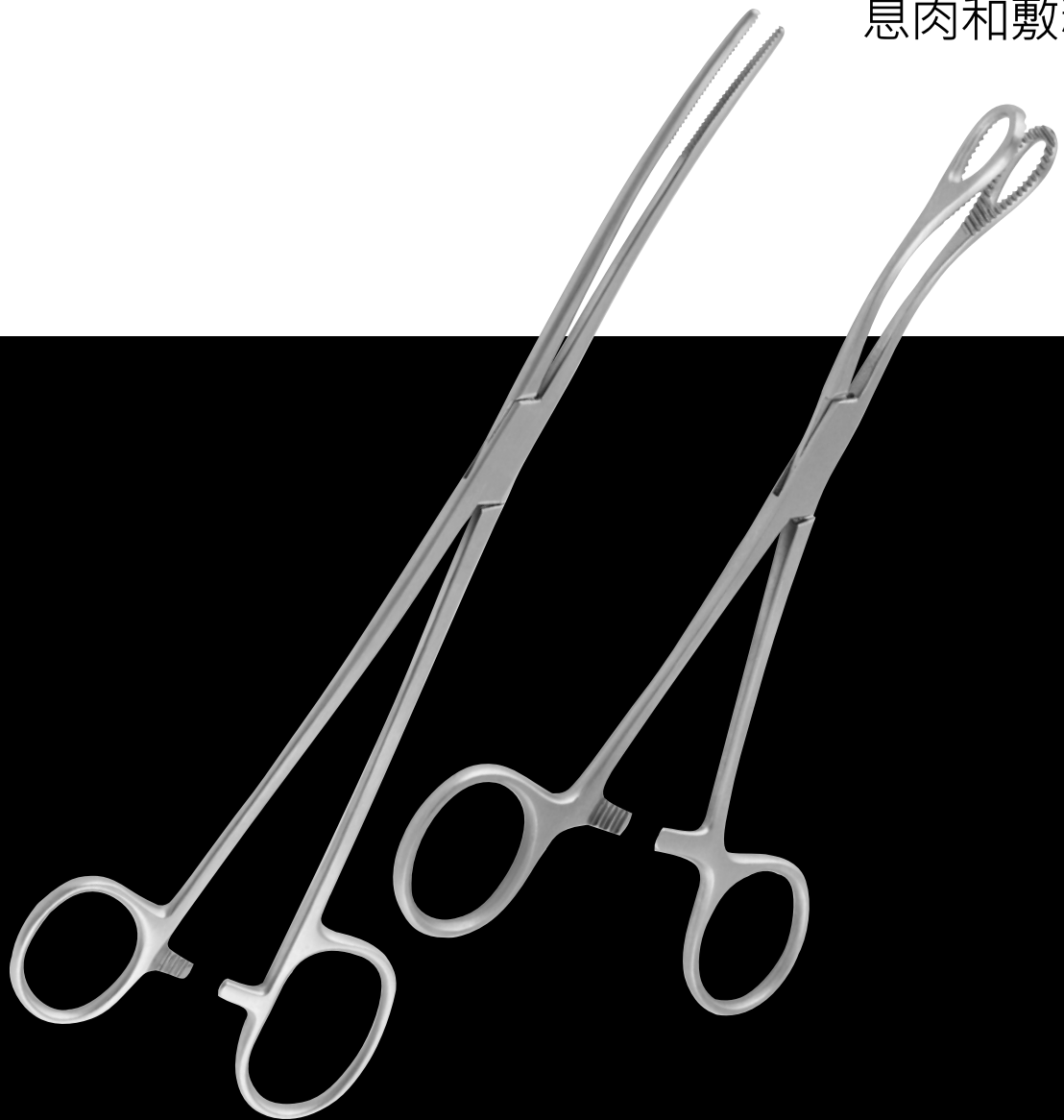



**GD08**



Dressing Forceps  
Tupferzangen  
Pincas à pansements  
Pinzas para tapones  
Pinzper medicatura

**GRAND**  
DEVICES  
*The Grand Instruments Company*

	
straight	curved
gerade	gebogen
droites	courbes
rectas	curvas
rette	curve



with ratchet  
mit Sperre  
avec crémaillère  
con cremallera  
con cremagliera

 **MARTIN**   
GD08.100.25 25.5 cm GD08.101.25





without ratchet  
ohne Sperre  
sans crémaillère  
sin cremallera  
senza cremagliera

 **GROSS-MAIER**   
GD08.104.18 18.0 cm GD08.105.18  
GD08.104.20 20.0 cm GD08.105.20  
GD08.104.25 25.0 cm GD08.105.25

Dressing Forceps  
Tupferzangen  
Pincès à pansements  
Pinzas para tapones  
Pinzeper medicatura





	
straight	curved
gerade	gebogen
droites	courbes
rectas	curvas
rette	curve



with ratchet  
mit Sperre  
avec crémaillère  
con cremallera  
con cremagliera



**GROSS-MAIER**

		
<b>GD08.106.18</b>	18.0 cm	<b>GD08.107.18</b>
<b>GD08.106.20</b>	20.0 cm	<b>GD08.107.20</b>
<b>GD08.106.25</b>	25.0 cm	<b>GD08.107.25</b>



without ratchet  
ohne Sperre  
sans crémaillère  
sin cremallera  
senza cremagliera



**GROSS-MAIER**

		
<b>GD08.108.13</b>	13.0 cm	<b>GD08.109.13</b>
<b>GD08.108.14</b>	14.0 cm	<b>GD08.109.14</b>



Dressing Forceps  
 Tupferzangen  
 Pinces à pansements  
 Pinzas para tapones  
 Pinzper medicatura



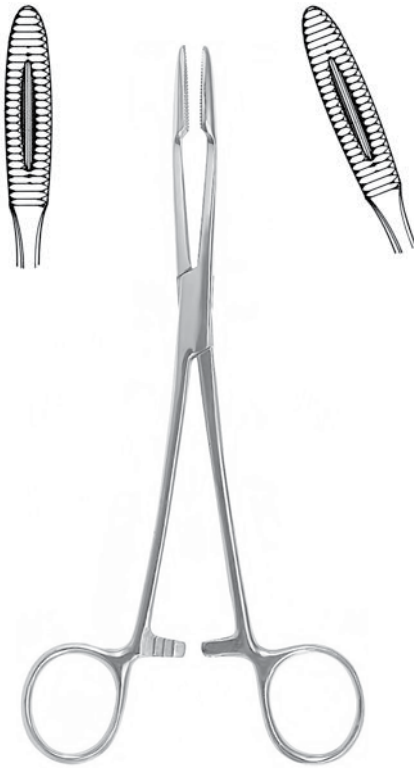

	
straight	curved
gerade	gebogen
droites	courbes
rectas	curvas
rette	curve

with ratchet  
 mit Sperre  
 avec crémaillère  
 con cremallera  
 con cremagliera





**GROSS-MAIER**

		
<b>GD08.110.14</b>	14.0 cm	<b>GD08.111.14</b>
<b>GD08.110.18</b>	18.0 cm	<b>GD08.111.18</b>
<b>GD08.110.20</b>	20.0 cm	<b>GD08.111.20</b>
<b>GD08.110.22</b>	22.0 cm	<b>GD08.111.22</b>
<b>GD08.110.25</b>	25.0 cm	<b>GD08.111.25</b>
<b>GD08.110.27</b>	27.0 cm	<b>GD08.111.27</b>
<b>GD08.110.36</b>	36.0 cm	<b>GD08.111.36</b>
<b>GD08.110.40</b>	40.0 cm	<b>GD08.111.40</b>

without ratchet  
 ohne Sperre  
 sans crémaillère  
 sin cremallera  
 senza cremagliera





**GROSS-MAIER**

		
<b>GD08.112.20</b>	20.0 cm	<b>GD08.113.20</b>
<b>GD08.112.25</b>	25.0 cm	<b>GD08.113.25</b>

Dressing Forceps  
 Tupferzangen  
 Pincas à pansements  
 Pinzas para tapones  
 Pinzper medicatura



	
straight	curved
gerade	gebogen
droites	courbes
rectas	curvas
rette	curve





with ratchet  
 mit Sperre  
 avec crémaillère  
 con cremallera  
 con cremagliera

 **GROSS**   
 GD08.114.18 18.0 cm GD08.115.18





with ratchet  
 mit Sperre  
 avec crémaillère  
 con cremallera  
 con cremagliera

 **SIMS-MAIER**   
 GD08.120.28 28.0 cm GD08.121.28



Sponge Holding Forceps  
Schwammzangen  
Pincés porte-éponges  
Pinzas porta esponjas  
Pinze per tamponi e spugne

**GRAND**  
DEVICES  
*The Grand Instruments Company*

	
straight	curved
gerade	gebogen
droites	courbes
rectas	curvas
rette	curve

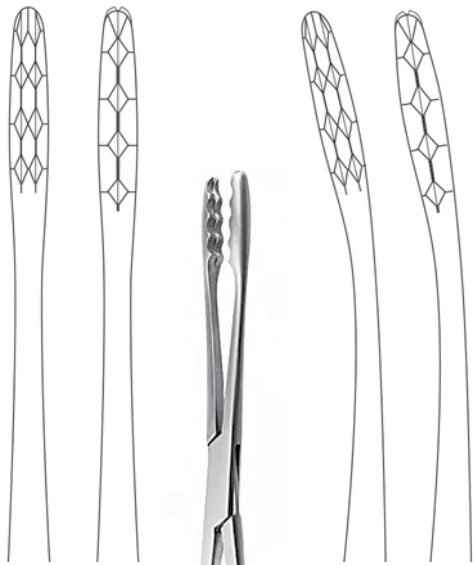



with ratchet  
mit Sperre  
avec crémaillère  
con cremallera  
con cremagliera



	ULRICH	
GD08.160.22	22.0 cm	GD08.161.22
GD08.160.25	25.0 cm	GD08.161.25
GD08.160.27	27.0 cm	GD08.161.27

Sponge Holding Forceps  
 Schwammzangen  
 Pinces porte-éponges  
 Pinzas porta esponjas  
 Pinze per tamponi e spugne



	
straight	curved
gerade	gebogen
droites	courbes
rectas	curvas
rette	curve

with ratchet  
 mit Sperre  
 avec crémaillère  
 con cremallera  
 con cremagliera

with ratchet  
 mit Sperre  
 avec crémaillère  
 con cremallera  
 con cremagliera



	<b>FOERSTER</b>	
<b>GD08.170.18</b>	18.0 cm	<b>GD08.171.18</b>
<b>GD08.170.20</b>	20.0 cm	<b>GD08.171.20</b>
<b>GD08.170.25</b>	25.0 cm	<b>GD08.171.25</b>
<b>GD08.170.30</b>	30.0 cm	<b>GD08.171.30</b>



	<b>FOERSTER</b>	
<b>GD08.172.18</b>	18.0 cm	<b>GD08.173.18</b>
<b>GD08.172.20</b>	20.0 cm	<b>GD08.173.20</b>
<b>GD08.172.25</b>	25.0 cm	<b>GD08.173.25</b>
<b>GD08.172.30</b>	30.0 cm	<b>GD08.173.30</b>





Sponge Holding Forceps  
Schwammzangen  
Pincés porte-éponges  
Pinzas porta esponjas  
Pinze per tamponi e spugne

**GRAND**  
DEVICES  
*The Grand Instruments Company*

	
straight gerade droites rectas rette	curved gebogen courbes curvas curve

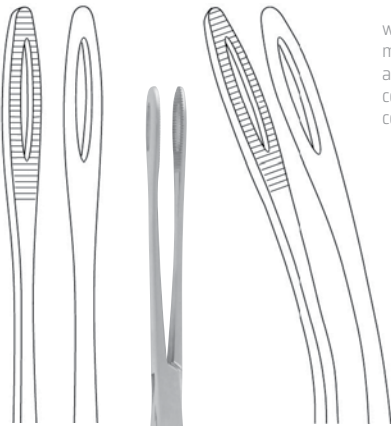

with ratchet  
mit Sperre  
avec crémaillère  
con cremallera  
con cremagliera

with ratchet  
mit Sperre  
avec crémaillère  
con cremallera  
con cremagliera





 **FORESTER**   
GD08.174.25 25.0 cm GD08.175.25



**BONNEY**  
24.0 cm GD08.176.24

Sponge Holding Forceps  
 Schwammzangen  
 Pinces porte-éponges  
 Pinzas porta esponjas  
 Pinze per tamponi e spugne



	
straight	curved
gerade	gebogen
droites	courbes
rectas	curvas
rette	curve



with ratchet  
 mit Sperre  
 avec crémaillère  
 con cremallera  
 con cremagliera

**RAMPLEY**

18.0 cm **GD08.178.18**  
 25.0 cm **GD08.178.25**



with ratchet  
 mit Sperre  
 avec crémaillère  
 con cremallera  
 con cremagliera



**RAMPLEY**

25.0 cm **GD08.180.25**





Sponge Holding Forceps  
Schwammzangen  
Pincés porte-éponges  
Pinzas porta esponjas  
Pinze per tamponi e spugne

**GRAND**<sup>®</sup>  
DEVICES  
*The Grand Instruments Company*

	
straight gerade droites rectas rette	curved gebogen courbes curvas curve





with ratchet  
mit Sperre  
avec crémaillère  
con cremallera  
con cremagliera

 **FLETCHER JAVERS**   
GD08.182.25    25.0 cm    GD08.183.25



with ratchet  
mit Sperre  
avec crémaillère  
con cremallera  
con cremagliera

 **BERGMANN FOERSTER**   
GD08.186.24    24.0 cm    GD08.187.24

Dressing Forceps  
Tupferzangen  
Pinces à pansements  
Pinzas para tapones  
Pinze per medicatura



without ratchet  
ohne Sperre  
sans crémaillère  
sin cremallera  
senza cremagliera

**BRYANT**

13.0 cm **GD08.207.13**



Sinus forceps  
Sinusklemme  
Pinces à sinus  
Pinzas para seno  
Pinze sinus

without ratchet  
ohne Sperre  
sans crémaillère  
sin cremallera  
senza cremagliera

**LISTER**

13.0 cm **GD08.210.13**  
16.0 cm **GD08.210.16**  
18.0 cm **GD08.210.18**

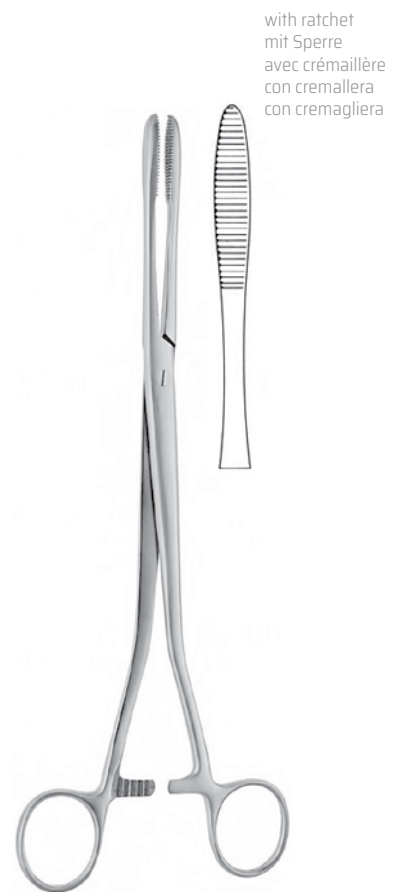

with ratchet  
mit Sperre  
avec crémaillère  
con cremallera  
con cremagliera



**COLLIN**

25.0 cm **GD08.220.25**



Dressing Forceps  
Tupferzangen  
Pinces à pansements  
Pinzas para tapones  
Pinze per medicatura

**GRAND**  
DEVICES  
The Grand Instruments Company

	
straight	curved
gerade	gebogen
droites	courbes
rectas	curvas
rette	curve

with ratchet  
mit Sperre  
avec crémaillère  
con cremallera  
con cremagliera



 **PELKMANN**   
GD08.226.25 25.0 cm GD08.227.25





**CHERON**  
25.0 cm GD08.229.25



**MAIER**  
25.0 cm GD08.230.25

Dressing Forceps  
 Tupferzangen  
 Pincès à pansements  
 Pinzas para taponos  
 Pinze per medicatura





	
straight	curved
gerade	gebogen
droites	courbes
rectas	curvas
rette	curve

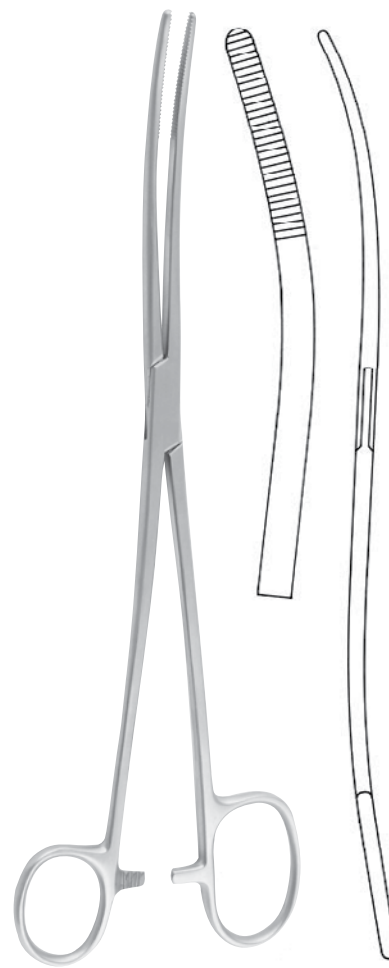

with ratchet  
 mit Sperre  
 avec crémaillère  
 con cremallera  
 con cremagliera



with ratchet  
 mit Sperre  
 avec crémaillère  
 con cremallera  
 con cremagliera



 **BOZEMANN**  
 GD08.230.26 26.0 cm  GD08.231.26

**BOZEMANN-DOUGLAS**  
 26.0 cm GD08.233.26



Dressing Forceps  
Tupferzangen  
Pincès à pansements  
Pinzas para tapones  
Pinze per medicatura

**GRAND**  
DEVICES  
*The Grand Instruments Company*

	
straight	curved
gerade	gebogen
droites	courbes
rectas	curvas
rette	curve



with ratchet  
mit Sperre  
avec crémaillère  
con cremallera  
con cremagliera



 **MARTIN**   
GD08.244.17 17.0 cm GD08.245.17

with ratchet  
mit Sperre  
avec crémaillère  
con cremallera  
con cremagliera



 **DUPLAY**   
GD08.246.20 20.0 cm GD08.247.20

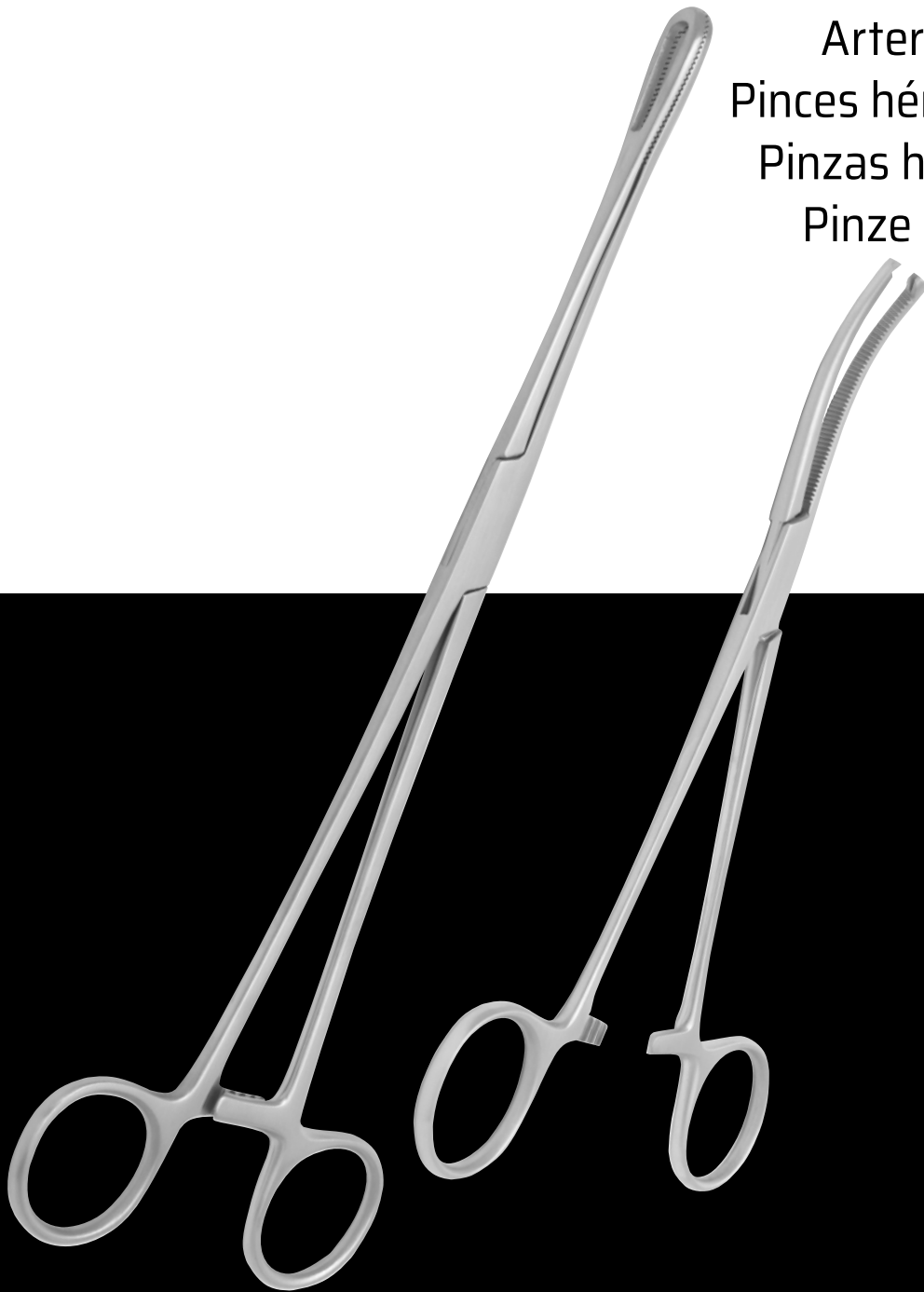

Hemostatic Forceps  
Arterienklemmen  
Pincès hémostatiques  
Pinzas hemostáticas  
Pinze emostatiche  
止血钳

**GD09**





Atrauma Bulldog Clamps  
 Atrauma-Bulldogklemmen  
 Clamps Bulldog Atrauma  
 Clamps Atrauma Bulldog  
 Pinze Atrauma Bulldog

**GRAND**  
 DEVICES  
*The Grand Instruments Company*

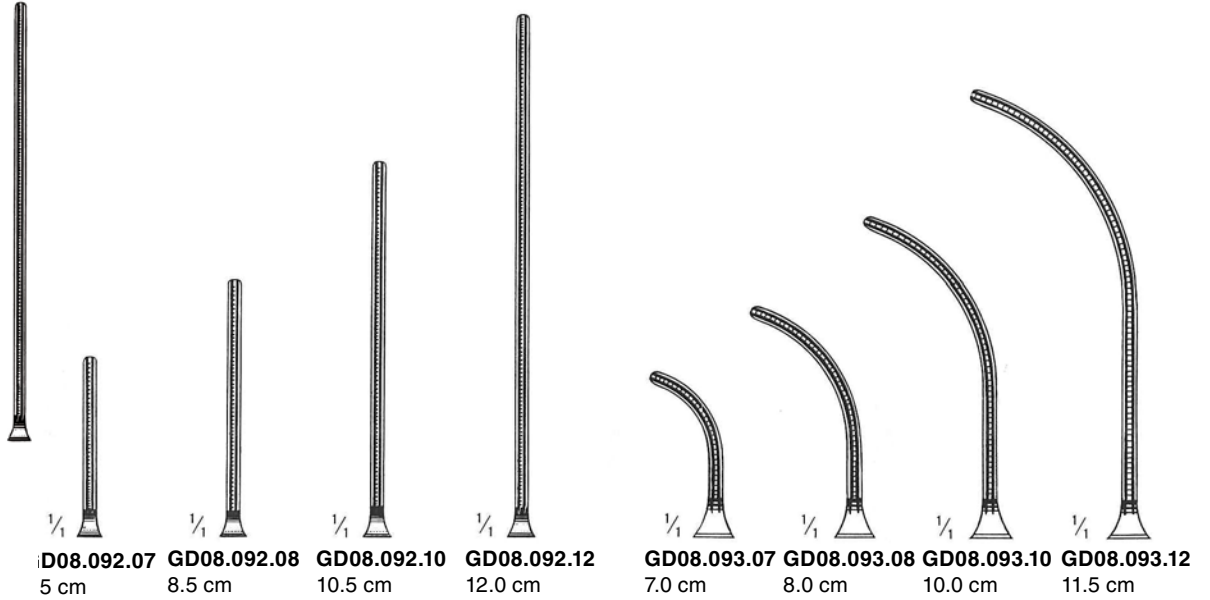

DE BAKEY

GD08.092.07 GD08.093.12

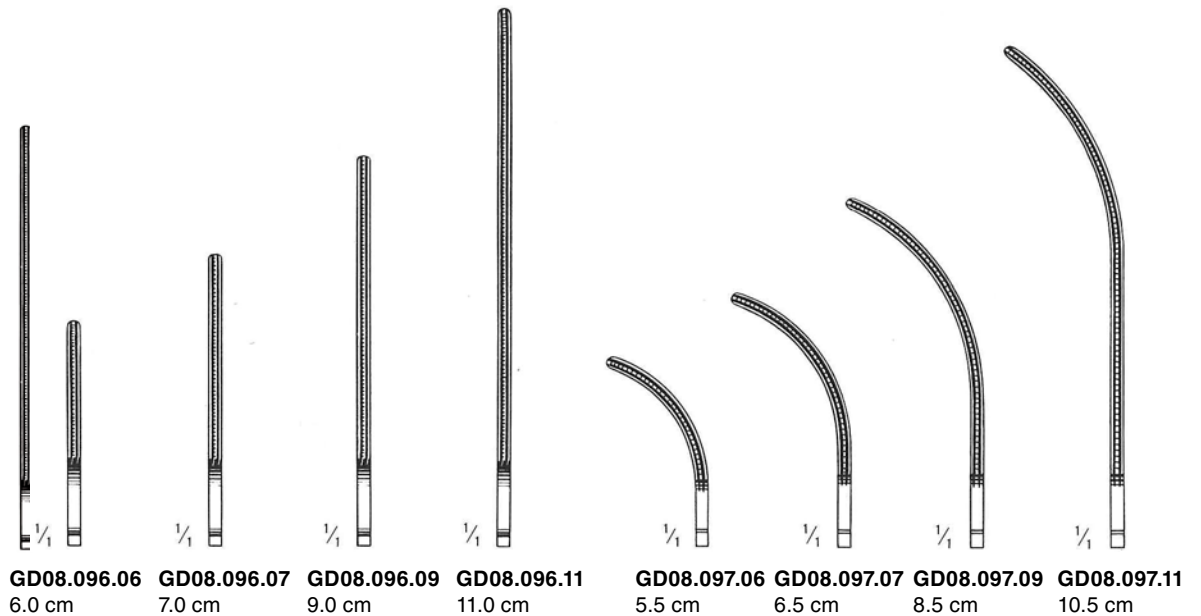

GLOVER

GD08.096.06 GD08.097.11

Hemostatic Forceps  
 Arterienklemmen  
 Pinces hémostatiques  
 Pinzas hemostáticas  
 Pinze emostatiche



Serrefines  
 Gefäßklemmen  
 Serre-fines  
 Serra-finas  
 Serrefine



**DIEFFENBACH**

**GD09.102.04**  
**GD09.102.05**

**GD09.103.04**  
**GD09.103.05**

3.0 cm  
 5.0 cm  
 5.5 cm  
 6.5 cm  
 7.0 cm  
 7.5 cm  
 9.0 cm



**JOHNS-HOPKINS**

**GD09.110.50**  
**GD09.110.55**

**GD09.111.50**  
**GD09.111.55**

**GD09.110.65**  
**GD09.110.70**  
**GD09.110.75**  
**GD09.110.90**

**GD09.111.65**  
**GD09.111.70**  
**GD09.111.75**  
**GD09.111.90**

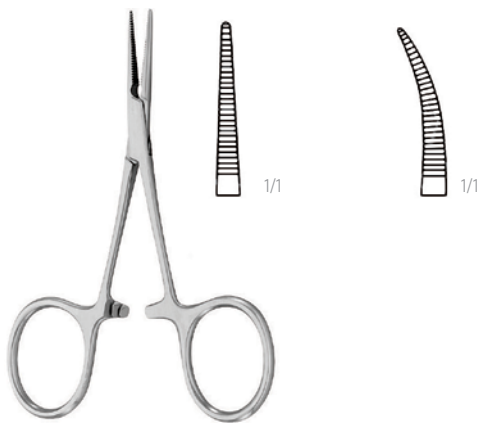

**HARTMANN**

**GD09.210.10** 10.0 cm **GD09.211.10**

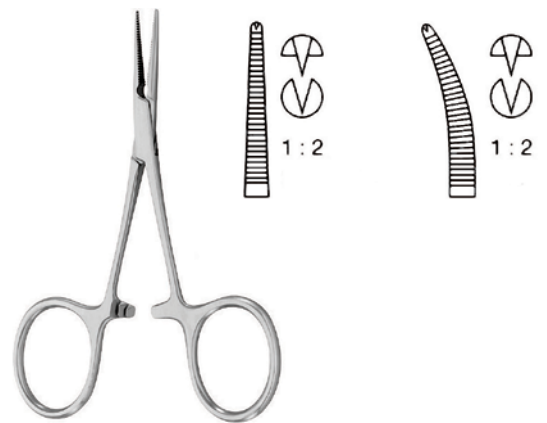

**HARTMANN**

**GD09.212.10** 10.0 cm **GD09.213.10**



Hemostatic Forceps  
 Arterienklemmen  
 Pincas hémostatiques  
 Pinzas hemostáticas  
 Pinze emostatiche



Titanium  
 Titan  
 Titane  
 Titanio

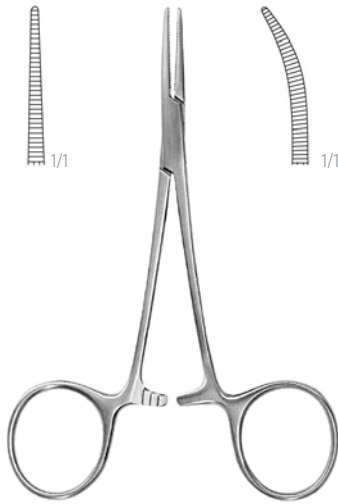

HALSTED-MOSQUITO

12.5 cm  
 14.0 cm  
 18.0 cm  
 21.0 cm

**GD09.224.12**

GD09.220.12  
 GD09.220.14  
 GD09.220.18  
 GD09.220.21

GD09.221.12  
 GD09.221.14  
 GD09.221.18  
 GD09.221.21

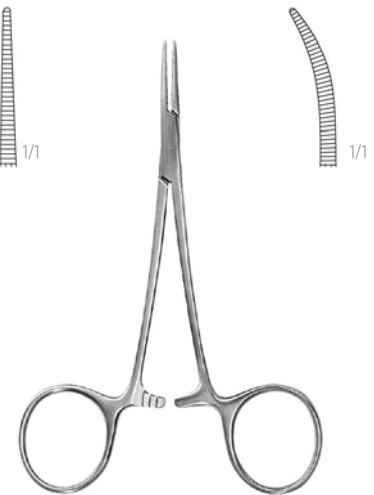

HALSTED-MOSQUITO micro

**GD09.225.12**

GD09.222.12 10.0 cm GD09.223.12

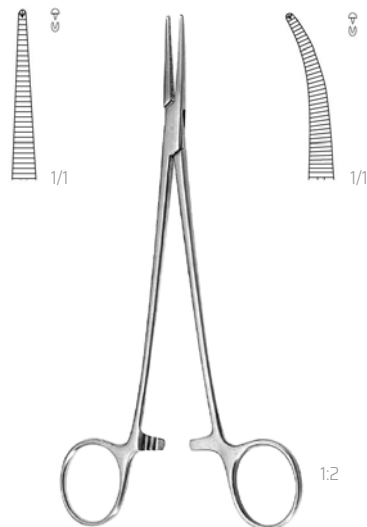

HALSTED-MOSQUITO

12.5 cm  
 14.0 cm  
 18.0 cm  
 21.0 cm

**GD09.234.12**

GD09.230.12  
 GD09.230.14  
 GD09.230.18  
 GD09.230.21

GD09.231.12  
 GD09.231.14  
 GD09.231.18  
 GD09.231.21

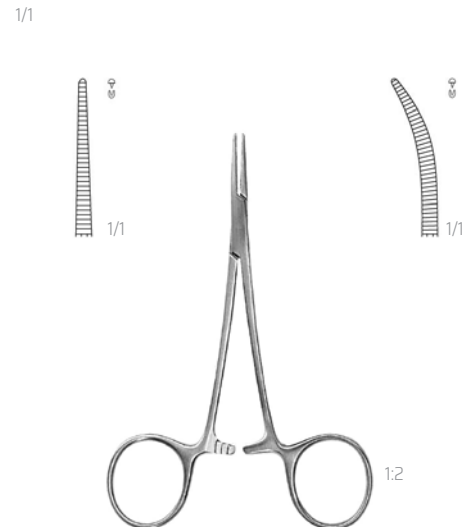

HALSTED-MOSQUITO micro

**GD09.235.12**

GD09.232.12 GD09.233.12

Hemostatic Forceps  
 Arterienklemmen  
 Pinces hémostatiques  
 Pinzas hemostáticas  
 Pinze emostatiche



Titanium  
 Titan  
 Titane  
 Titanio

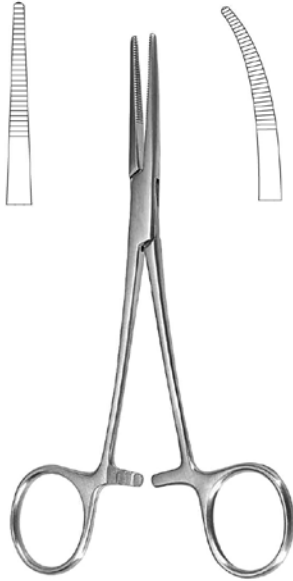

KELLY

14.0 cm **GD09.240.14 GD09.241.14**  
 14.0 cm **GD09.244.14 GD09.245.14**  
 16.0 cm

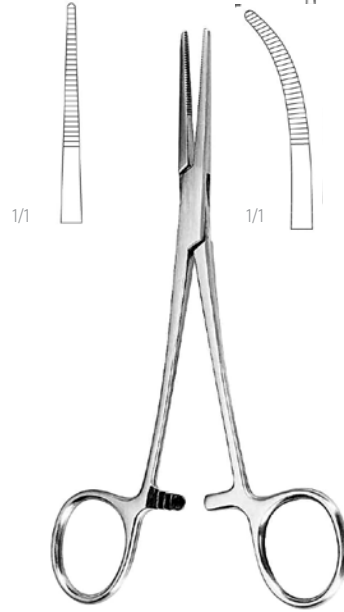

KELLY-RANKIN

GD09.242.16 GD09.243.16

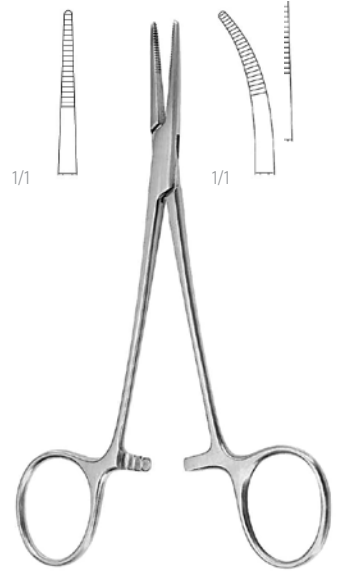

PROVIDENCE-HOSPITAL

GD09.270.14 GD09.271.14

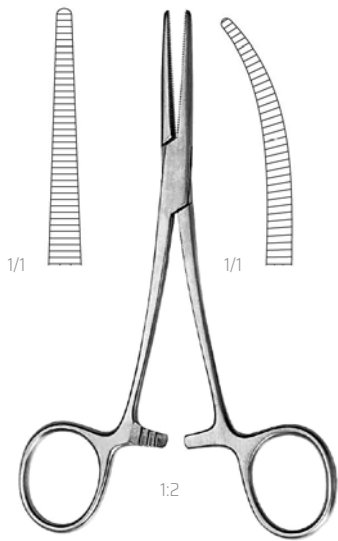

CRILLE

14.0 cm **GD09.250.14 GD09.251.14 GD09.260.14 GD09.261.14**  
 14.0 cm **GD09.254.14 GD09.255.14**  
 16.0 cm

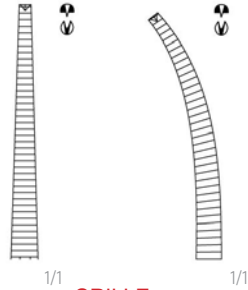

CRILLE

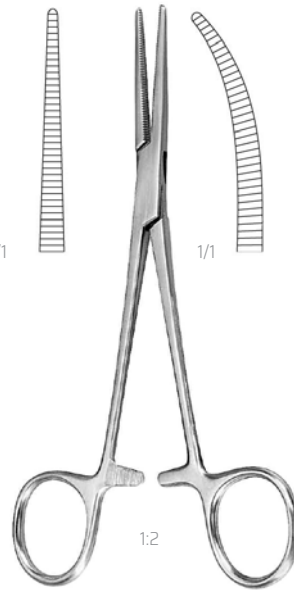

CRILE-RANKIN

GD09.262.16 GD09.263.16

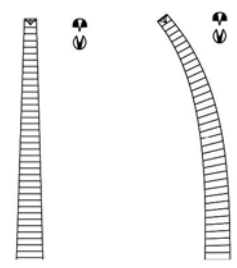

CRILE-RANKIN

GD09.264.16 GD09.265.16



Hemostatic Forceps  
 Arterienklemmen  
 Pinces hémostatiques  
 Pinzas hemostáticas  
 Pinze emostatiche

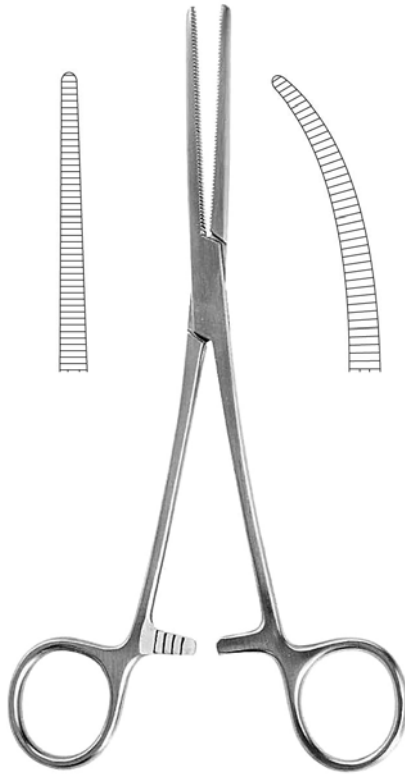

**ROCHESTER-PEAN**

13.0 cm	<b>GD09.310.13</b>	<b>GD09.311.13</b>
14.0 cm	<b>GD09.310.14</b>	<b>GD09.311.14</b>
16.0 cm	<b>GD09.310.16</b>	<b>GD09.311.16</b>
18.0 cm	<b>GD09.310.18</b>	<b>GD09.311.18</b>
20.0 cm	<b>GD09.310.20</b>	<b>GD09.311.20</b>
22.0 cm	<b>GD09.310.22</b>	<b>GD09.311.22</b>
24.0 cm	<b>GD09.310.24</b>	<b>GD09.311.24</b>
26.0 cm	<b>GD09.310.26</b>	<b>GD09.311.26</b>
30.0 cm	<b>GD09.310.30</b>	<b>GD09.311.30</b>

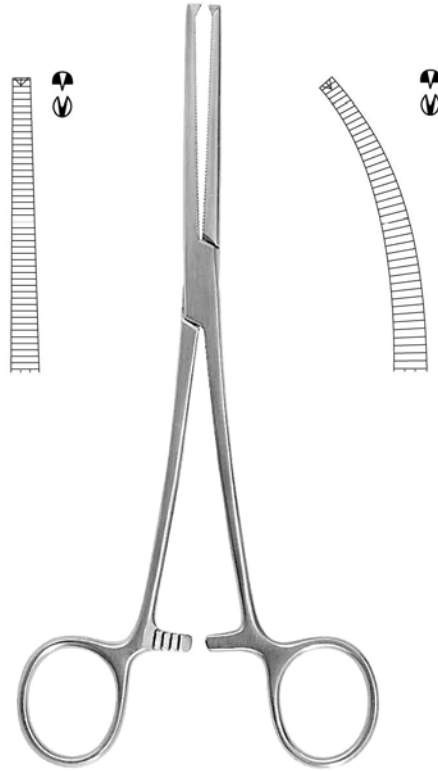

**ROCHESTER-OCHSNER**

<b>GD09.320.13</b>	<b>GD09.321.13</b>
<b>GD09.320.14</b>	<b>GD09.321.14</b>
<b>GD09.320.16</b>	<b>GD09.321.16</b>
<b>GD09.320.18</b>	<b>GD09.321.18</b>
<b>GD09.320.20</b>	<b>GD09.321.20</b>
<b>GD09.320.22</b>	<b>GD09.321.22</b>
<b>GD09.320.24</b>	<b>GD09.321.24</b>
<b>GD09.320.26</b>	<b>GD09.321.26</b>
<b>GD09.320.30</b>	<b>GD09.321.30</b>

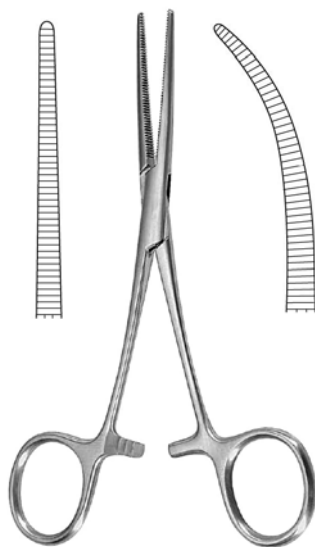

**PEAN**

<b>GD09.312.14</b>	14.0 cm	<b>GD09.313.14</b>
<b>GD09.312.16</b>	16.0 cm	<b>GD09.313.16</b>

Delicate Model  
 Graziles Modell  
 Modèle délicat  
 Modelo delgado  
 Modello delicato

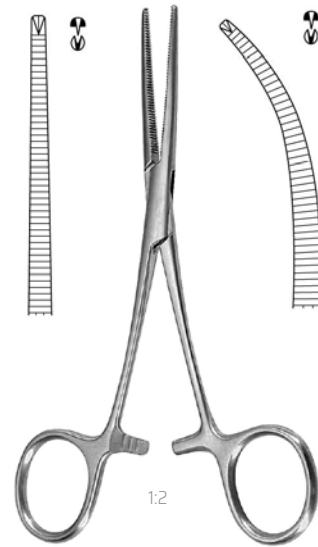

**KOCHER**

<b>GD09.322.14</b>	14.0 cm	<b>GD09.323.14</b>
<b>GD09.322.16</b>	16.0 cm	<b>GD09.323.16</b>

1:2

Hemostatic Forceps  
 Arterienklemmen  
 Pincas hémostatiques  
 Pinzas hemostáticas  
 Pinze emostatiche

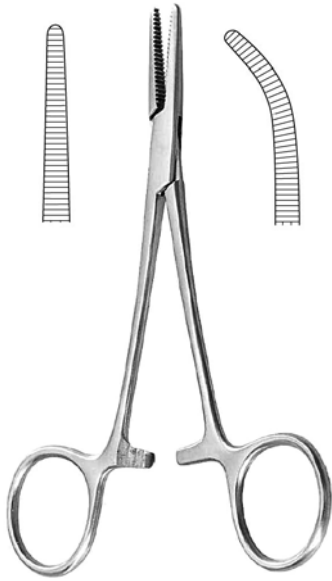

**SPENCER-WELLS**

- |                    |         |                    |
|--------------------|---------|--------------------|
| <b>GD09.330.13</b> | 13.0 cm | <b>GD09.331.13</b> |
| <b>GD09.330.15</b> | 15.0 cm | <b>GD09.331.15</b> |
| <b>GD09.330.18</b> | 18.0 cm | <b>GD09.331.18</b> |
| <b>GD09.330.20</b> | 20.0 cm | <b>GD09.331.20</b> |

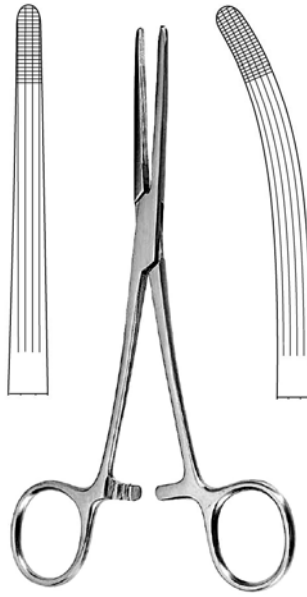

**ROCHESTER-CARMALT**

- |                    |         |                    |
|--------------------|---------|--------------------|
| <b>GD09.340.16</b> | 16.0 cm | <b>GD09.341.16</b> |
| <b>GD09.340.20</b> | 20.0 cm | <b>GD09.341.20</b> |

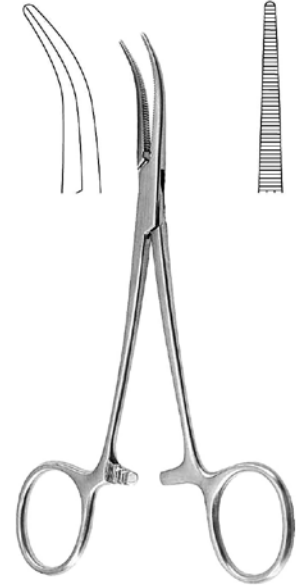

**DANY**

- |         |                    |
|---------|--------------------|
| 14.0 cm | <b>GD09.345.14</b> |
|---------|--------------------|

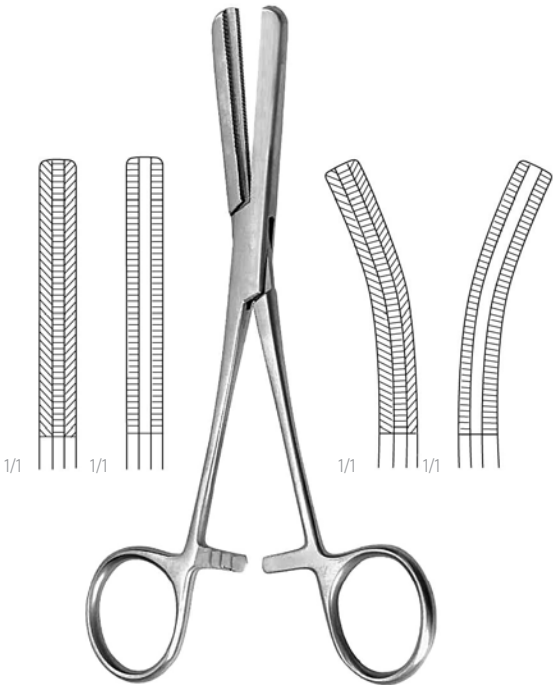

**FERGUSSON**

- |                    |         |                    |
|--------------------|---------|--------------------|
| <b>GD09.350.16</b> | 16.0 cm | <b>GD09.351.16</b> |
| <b>GD09.350.20</b> | 20.0 cm | <b>GD09.351.20</b> |



**LOVELACE**

- |         |                    |
|---------|--------------------|
| 15.5 cm | <b>GD09.356.15</b> |
|---------|--------------------|



**PENNINGTON**

- |         |                    |
|---------|--------------------|
| 15.5 cm | <b>GD09.358.15</b> |
| 20.0 cm | <b>GD09.358.20</b> |



Hemostatic Forceps  
Arterienklemmen  
Pinces hémostatiques  
Pinzas hemostáticas  
Pinze emostatiche

**GRAND**  
DEVICES  
*The Grand Instruments Company*



**PRATT**

15.0 cm **GD09.360.15**

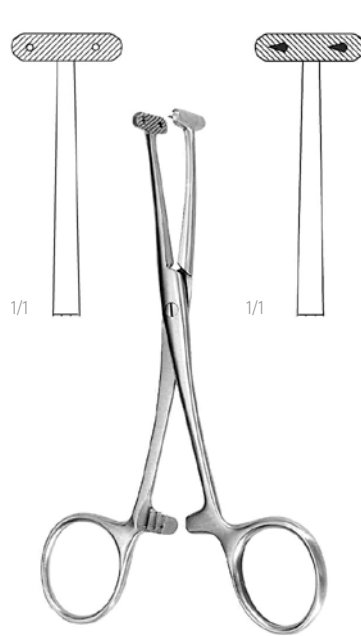

**MARTEL**

14.0 cm **GD09.364.14**

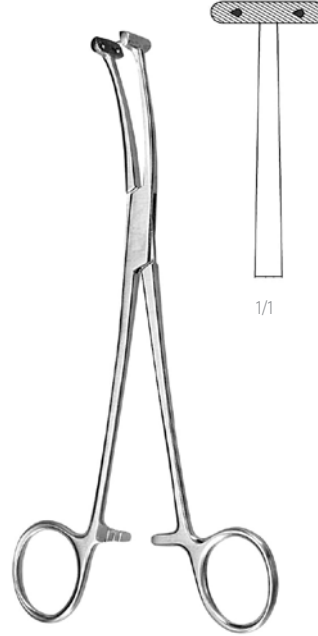

**WILLET-MARTEL**

19.0 cm **GD09.366.19**

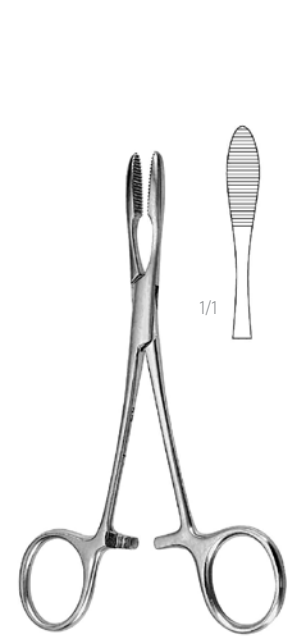

**PEAN**

14.0 cm **GD09.368.14**  
16.0 cm **GD09.368.16**

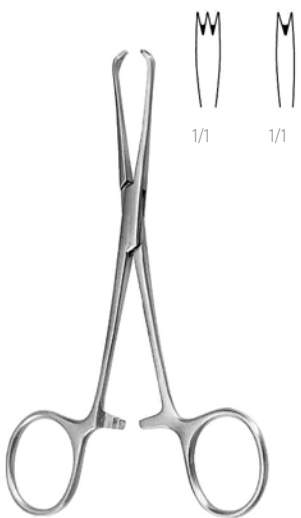

**CHAPUT**

13.0 cm **GD09.370.13**



**TUFFIER**

13.0 cm **GD09.372.13**



**COLLIN**

14.0 cm **GD09.374.14**



**COLLIN**

16.0 cm **GD09.376.16**



Hemostatic Forceps  
 Arterienklemmen  
 Pinces hémostatiques  
 Pinzas hemostáticas  
 Pinze emostatiche

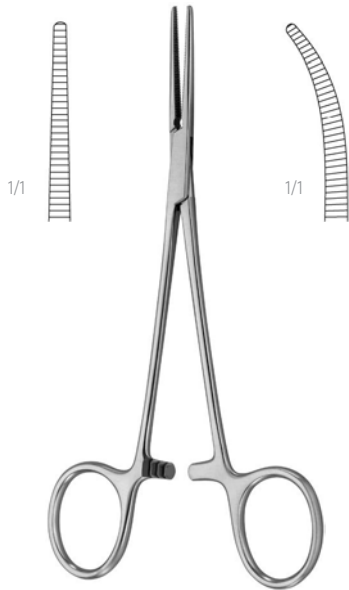

**LERICHE**

**GD09.380.15** 15.0 cm

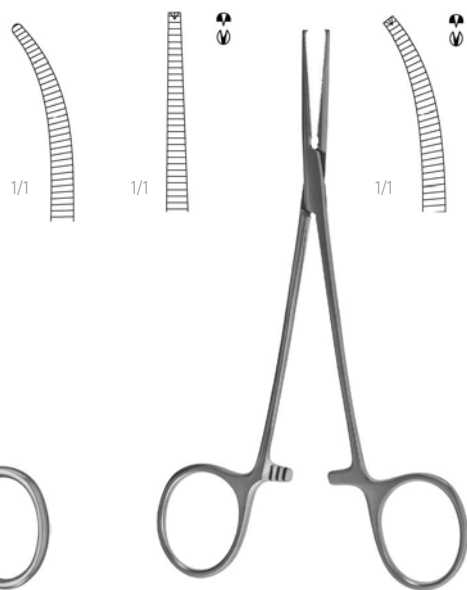

**LERICHE**

**GD09.381.15** 15.0 cm

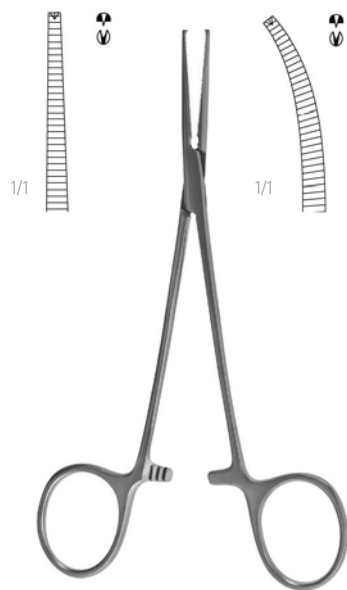

**GD09.382.15** 15.0 cm

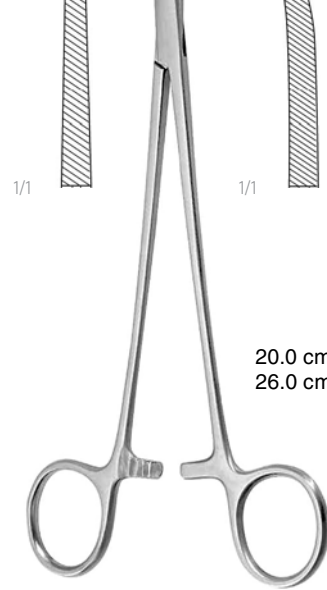

**BENGOLEA**

**GD09.384.20** 20.0 cm

**GD09.385.20** 20.0 cm

**GD09.384.26** 26.0 cm

**GD09.385.26** 26.0 cm

**BENGOLEA**

20.0 cm

26.0 cm

**GD09.386.20** **GD09.387.20**

**GD09.386.26** **GD09.387.26**

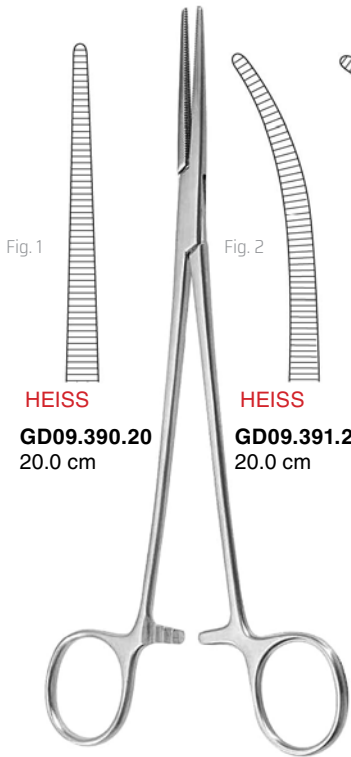

**HEISS**

**GD09.390.20**  
20.0 cm

**HEISS**

**GD09.391.20**  
20.0 cm

**HEISS**

**GD09.393.20**  
20.0 cm

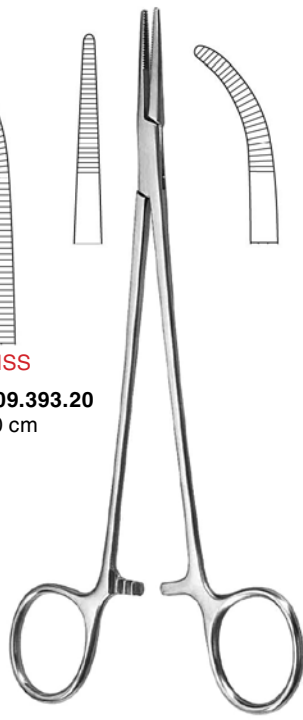

**ADSON**

**GD09.410.18** 18.5 cm

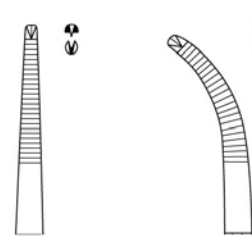

**ADSON**

**GD09.411.18** **GD09.412.18** 18.5 cm

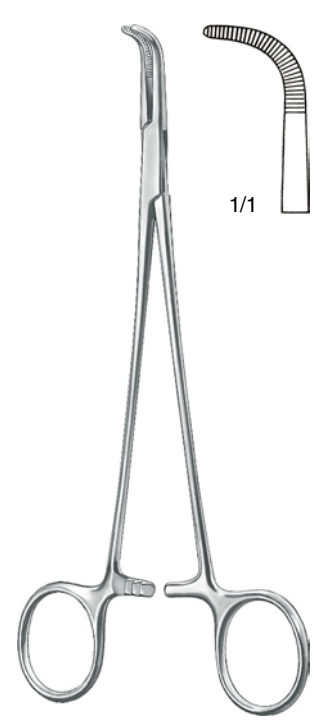

**ADSON Baby**

**GD09.413.18** **GD09.415.18**





**Hemostatic Forceps**  
**Arterienklemmen**  
**Pinces hémostatiques**  
**Pinzas hemostáticas**  
**Pinze emostatiche**



Dissecting and Ligature Forceps  
 Präparier- und Ligaturklemmen  
 Pincès à dissection et à ligatures  
 Pinzas para disección y ligaduras  
 Pinze per dissezione e per legature (Passafil)

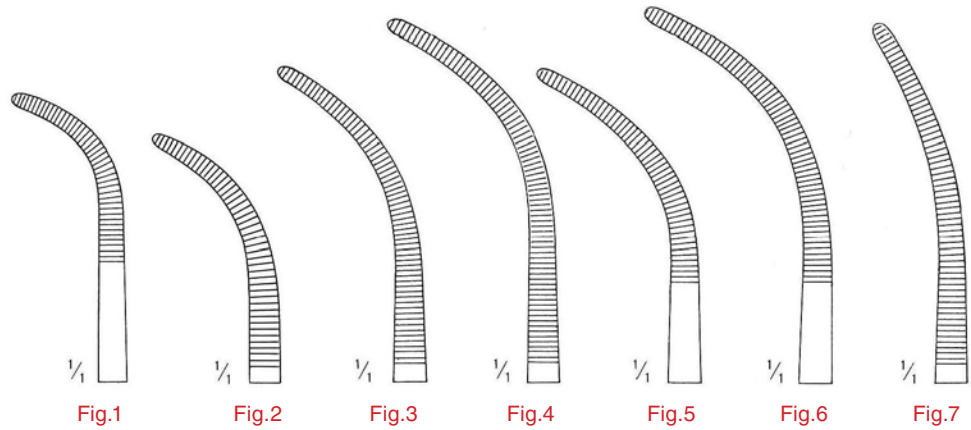
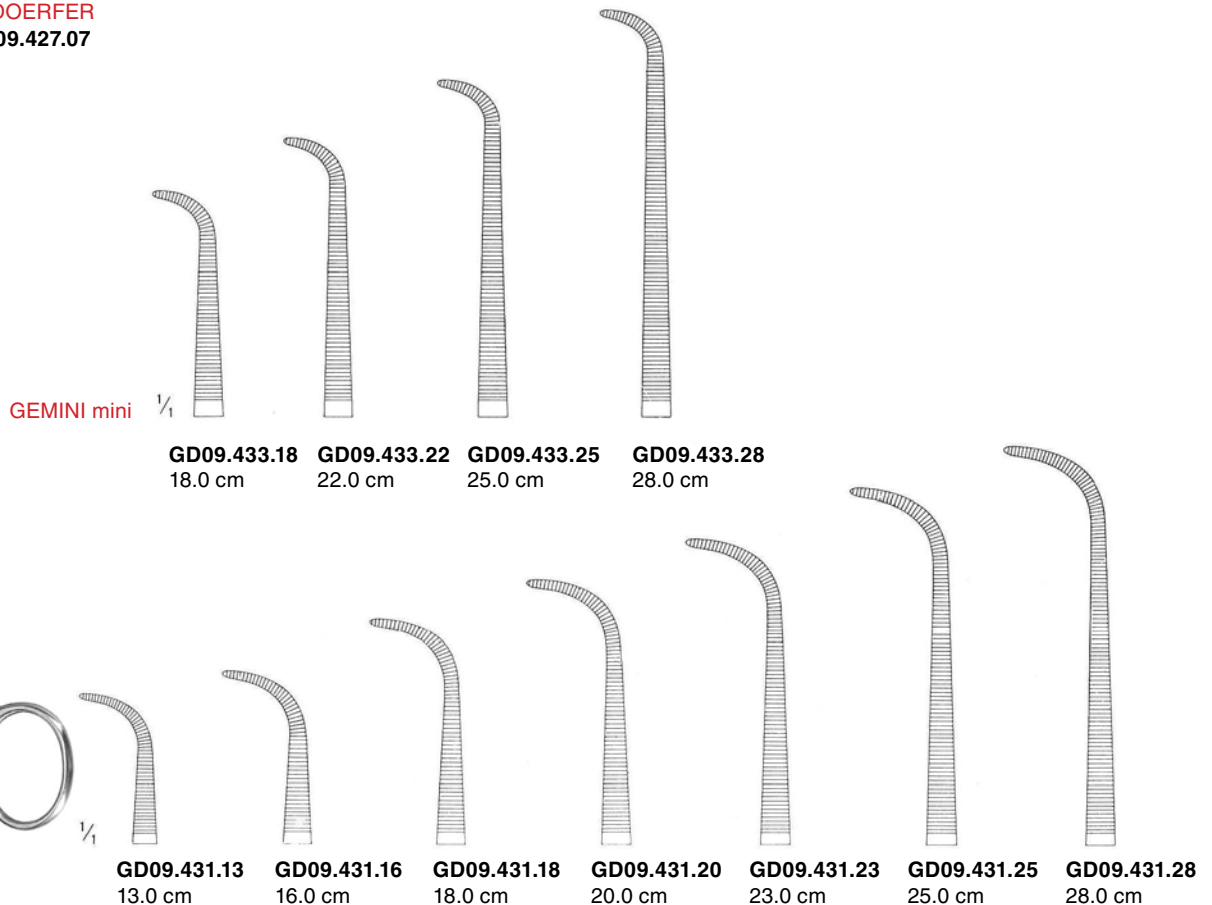

Fig.1 21.0 cm **GD09.421.01** Fig.2 **GD09.421.02** Fig.3 **GD09.421.03** Fig.4 **GD09.421.04** Fig.5 **GD09.421.05** Fig.6 **GD09.421.06** Fig.7 **GD09.421.07**  
 27.0 cm **GD09.427.01** **GD09.427.02** **GD09.427.03** **GD09.427.04** **GD09.427.05** **GD09.427.06** **GD09.427.07**

**OVERHOLT-GEISSENDOERFER**  
**GD09.421.01 - GD09.427.07**



**GEMINI mini**  $\frac{1}{4}$  **GD09.433.18** **GD09.433.22** **GD09.433.25** **GD09.433.28**  
 18.0 cm 22.0 cm 25.0 cm 28.0 cm

**GEMINI**  $\frac{1}{4}$  **GD09.431.13** **GD09.431.16** **GD09.431.18** **GD09.431.20** **GD09.431.23** **GD09.431.25** **GD09.431.28**  
 13.0 cm 16.0 cm 18.0 cm 20.0 cm 23.0 cm 25.0 cm 28.0 cm

Hemostatic Forceps  
 Arterienklemmen  
 Pinces hémostatiques  
 Pinzas hemostáticas  
 Pinze emostatiche

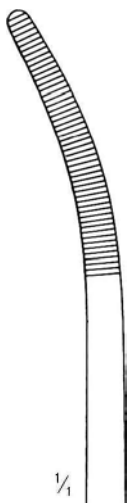

**GD09.441.00**  
 24 cm / 9½"



**GD09.441.01**  
 24 cm / 9½"

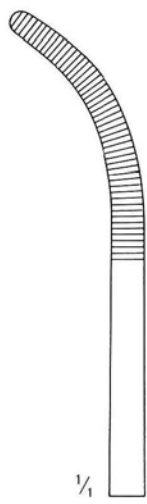

**GD09.441.02**  
 23.5 cm / 9¼"

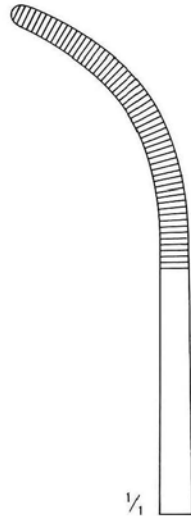

**GD09.441.03**  
 24 cm / 9½"

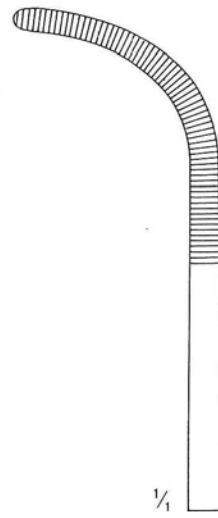

**GD09.441.04**  
 24 cm / 9½"



**RUMEL**



21.0 cm **GD09.442.21**  
 26.0 cm **GD09.442.26**

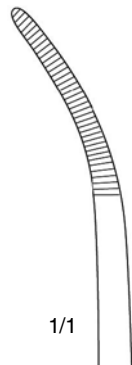

21.0 cm **GD09.443.21**  
 26.0 cm **GD09.443.26**



21.0 cm **GD09.444.21**  
 26.0 cm **GD09.444.26**

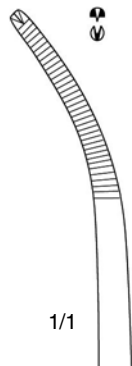

21.0 cm **GD09.445.21**  
 26.0 cm **GD09.445.26**

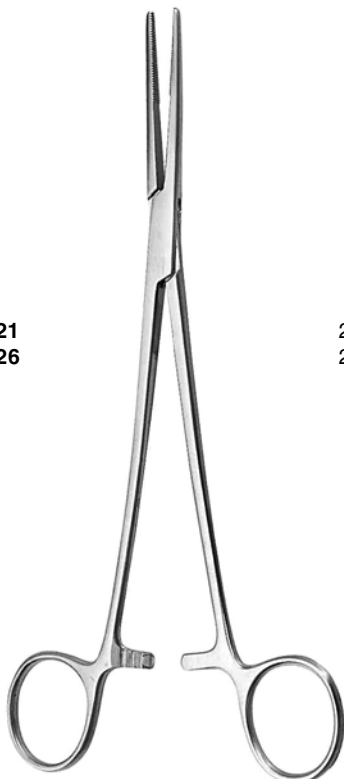

**TOENNIS**

21.0 cm **GD09.442.21** 26.0 cm **GD09.445.26**

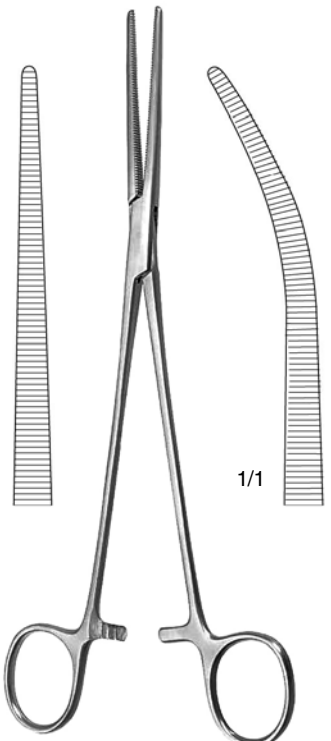

**ROBERTS**

**GD09.4GD09.22** 22.0 cm **GD09.449.22**



Hemostatic Forceps  
Arterienklemmen  
Pinces hémostatiques  
Pinzas hemostáticas  
Pinze emostatiche

**GRAND**  
DEVICES  
The Grand Instruments Company

Bronchus Forceps  
Bronchusklemmen  
Pinces-Clamps à Bronches  
Pinzas clamps bronquiales  
Pinze per bronchi

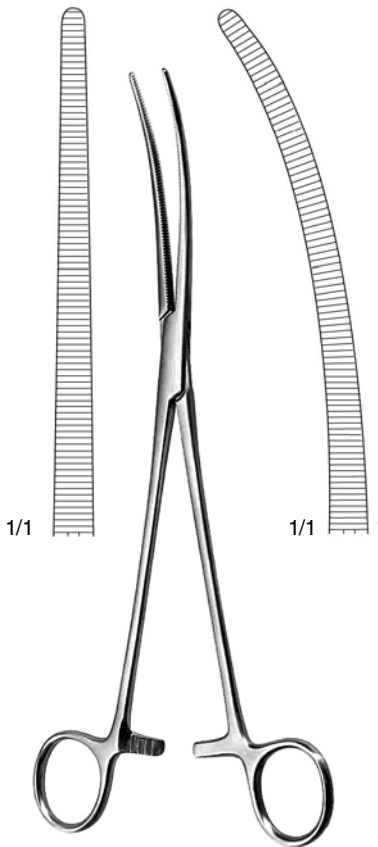

**SAROT**  
GD09.450.24 24 cm GD09.451.24

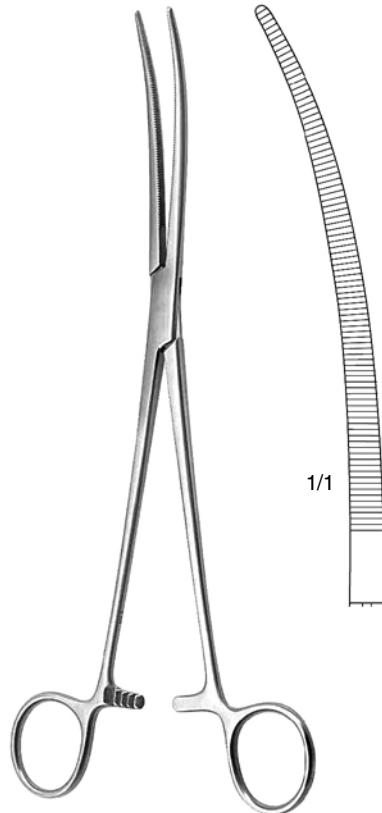

**CRAFOORD**  
24.0 cm GD09.453.24

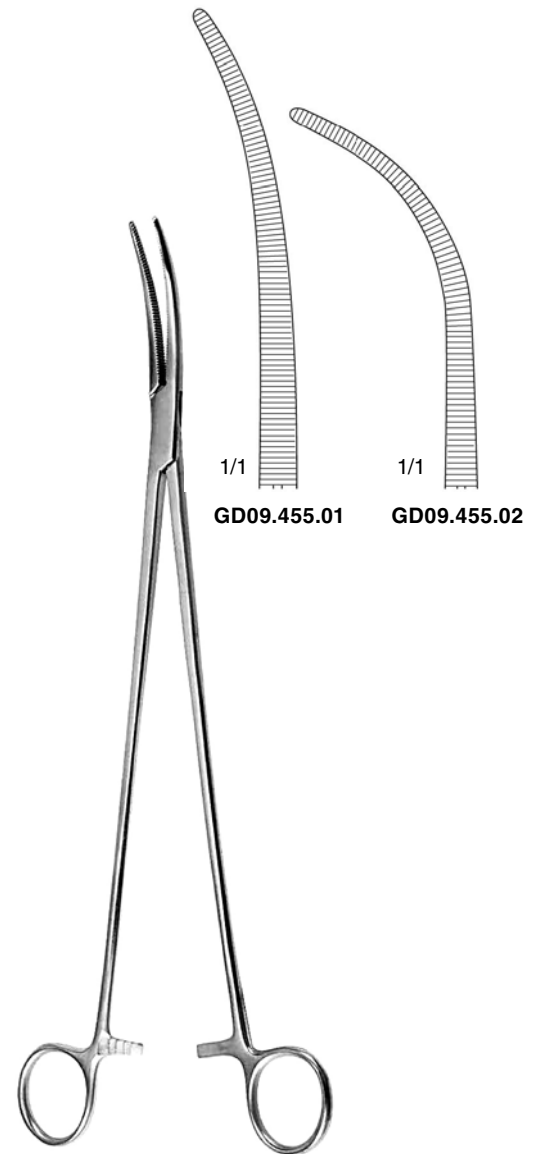

**ZENKER**  
29.5 cm GD09.455.01 GD09.455.02

Hemostatic Forceps  
 Arterienklemmen  
 Pinces hémostatiques  
 Pinzas hemostáticas  
 Pinze emostatiche

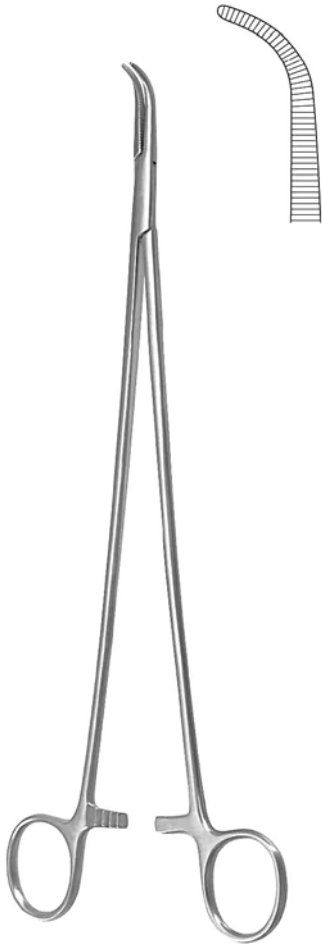

**LAWRENCE**  
 28.0 cm **GD09.457.28**



**MEEKER**  
 28.0 cm **GD09.459.28**

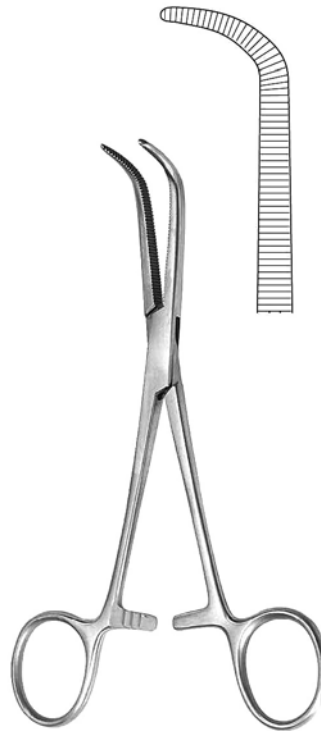

**MIXTER**  
 14.0 cm **GD09.471.14**  
 16.0 cm **GD09.471.16**  
 18.0 cm **GD09.471.18**  
 23.0 cm **GD09.471.23**

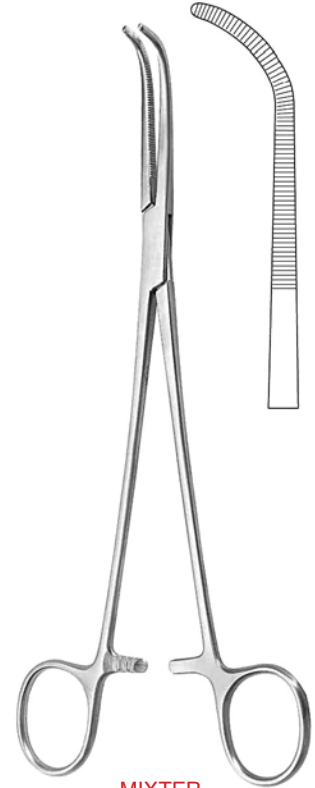

**MIXTER**  
 22.0 cm **GD09.473.22**

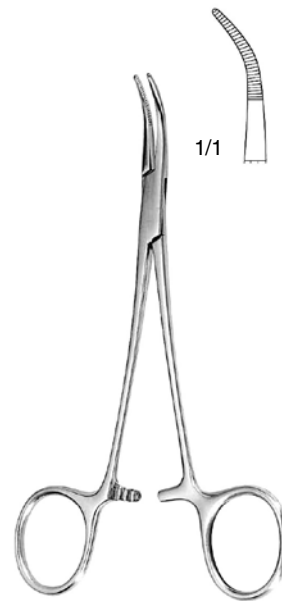

**MIXTER Baby**  
 14.0 cm **GD09.475.14**



**MIXTER Baby**  
 18.0 cm **GD09.475.18**



**Hemostatic Forceps**  
**Arterienklemmen**  
**Pinces hémostatiques**  
**Pinzas hemostáticas**  
**Pinze emostatiche**



Hemostatic, Gall Duct, and Kidney Pedicle  
 Arterien, Gallenkanal, Nierenstiel  
 Hémostatiques, pédicule rénal et voies biliaires  
 Hemstáticas, pedículo renal y vías biliares  
 Emostatiche, pedunculo renale e vie biliari

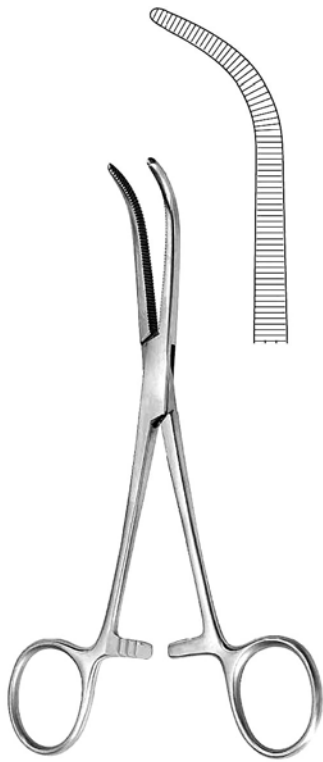

**MIXTER-O'SHAUGHNESSY**

15.5 cm **GD09.477.15**  
 19.0 cm **GD09.477.19**



**MIXTER**

**GD09.479.22 -**  
**GD09.479.28**

1/1

**GD09.479.22** **GD09.479.25** **GD09.479.28**  
 22.0 cm 25.0 cm 28.0 cm



**BAINBRIDGE**

**GD09.480.15** 15.0 cm **GD09.481.15**  
**GD09.480.18** 18.5 cm **GD09.481.18**

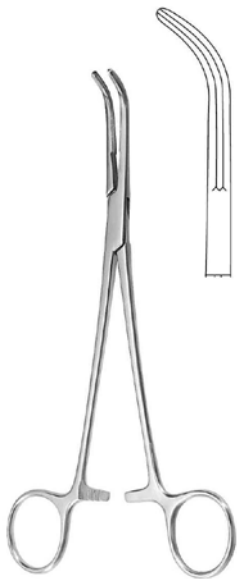

**LAHEY**

19.0 cm **GD09.491.19**



**LAHEY**

23.0 cm **GD09.493.23**



**LOWER**

18.0 cm **GD09.495.18**

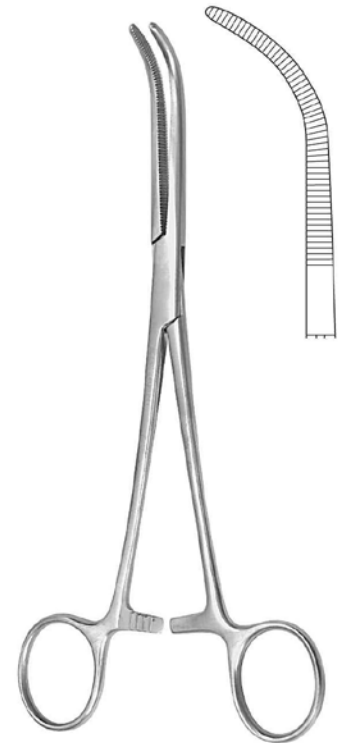

**JOHNS-HOPKINS**

20.0 cm **GD09.497.20**

Hemostatic Forceps  
 Arterienklemmen  
 Pinces hémostatiques  
 Pinzas hemostáticas  
 Pinze emostatiche



Gall Duct • Gallenkanal •  
 Voies biliaires • Vias  
 biliaires • Vie biliari

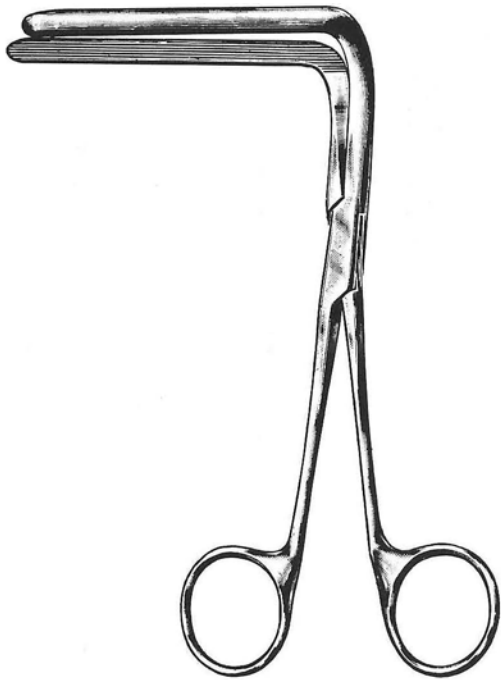

**MIXTER**  
 16.5 cm **GD09.499.16**

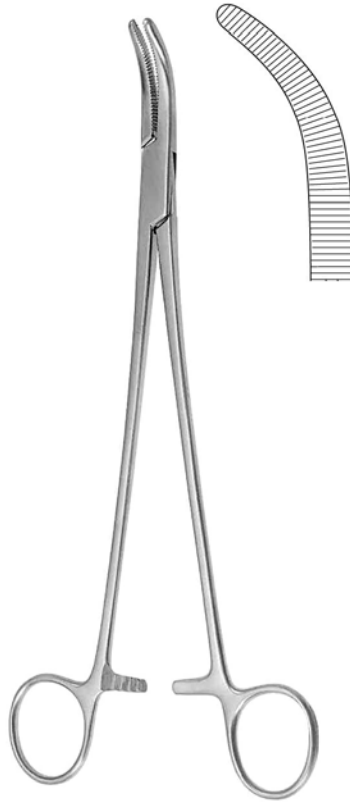

**MOYNIHAN**  
 23.0 cm **GD09.501.23**

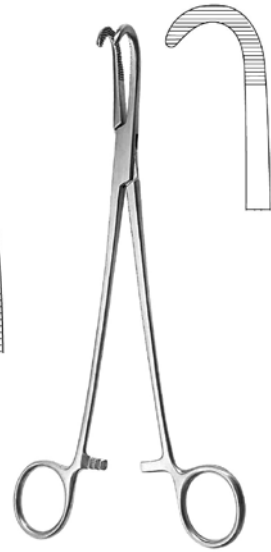

**DESJARDINS**  
 21.0 cm **GD09.503.21**  
 (Cysticus)

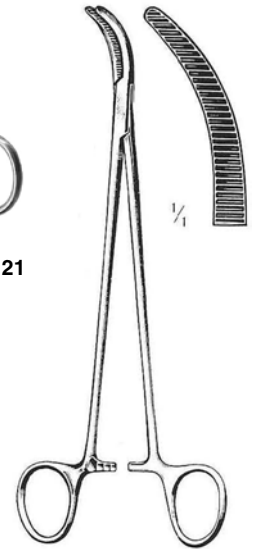

**DESJARDINS**  
 21.0 cm **GD09.505.21**

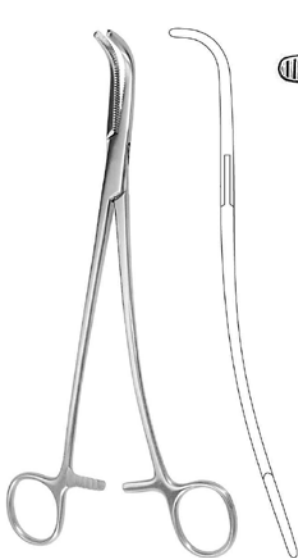

**GRAY**  
 Cholecystectomie

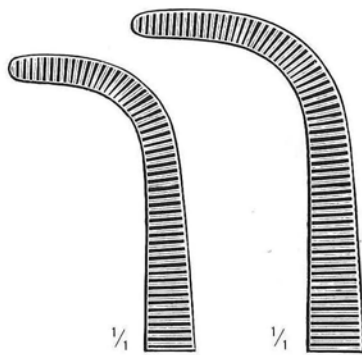

**GD09.507.22** 22.0 cm  
**GD09.507.23** 23.0 cm

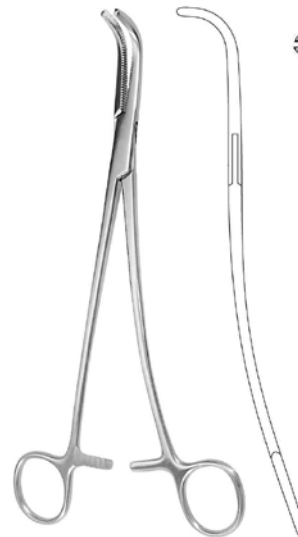

**GRAY**

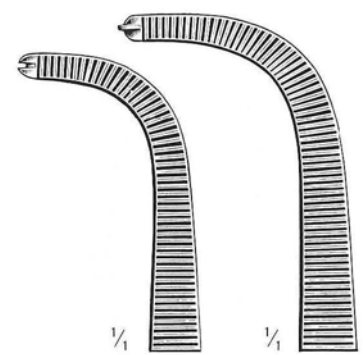

**GD09.509.22** 22.0 cm  
**GD09.509.23** 23.0 cm

1:2





Hemostatic Forceps  
 Arterienklemmen  
 Pinces hémostatiques  
 Pinzas hemostáticas  
 Pinze emostatiche

**GRAND**  
 DEVICES  
 The Grand Instruments Company

Kidney Pedicle, Gall Duct  
 Nierenstiel, Gallenkanal  
 Pédicule rénal, conduit biliaire  
 Pediculo renal, vías biliares  
 Pedunculo renale, vie biliari



**STILLE**

23.0 cm **GD09.513.23**



**MAYO-GUYON**

23.0 cm **GD09.515.23**

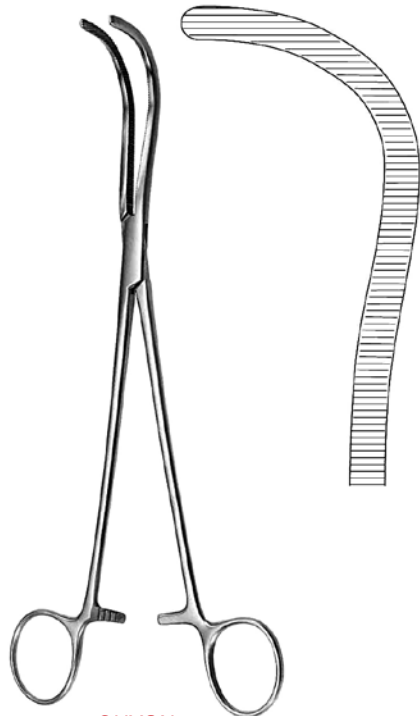

**GUYON**

23.0 cm **GD09.517.23**



**GUYON**

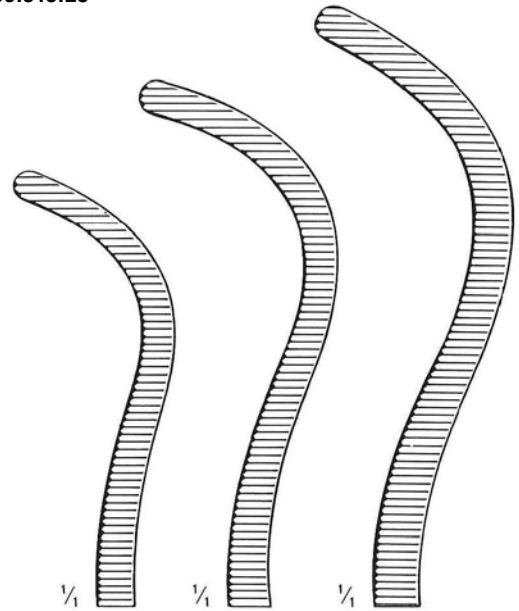

**GD09.519.20** **GD09.519.22** **GD09.479.22**  
 20.0 cm 22.0 cm 24.0 cm

Hemostatic Forceps  
 Arterienklemmen  
 Pincas hémostatiques  
 Pinzas hemostáticas  
 Pinze emostatiche



Kidney Pedicle  
 Nierenstiel  
 Pédicule rénal  
 Pediculo renal  
 Peduncolo renale

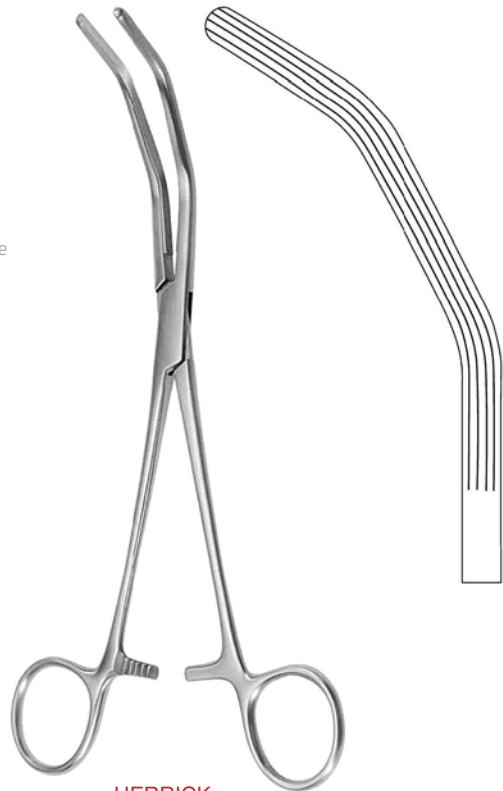

**HERRICK**

23.0 cm **GD09.523.23**

Peritoneum Forceps  
 Peritoneum-Klemmen  
 Pincas à péritoine  
 Pinzas para peritoneo  
 Pinze peritoneali

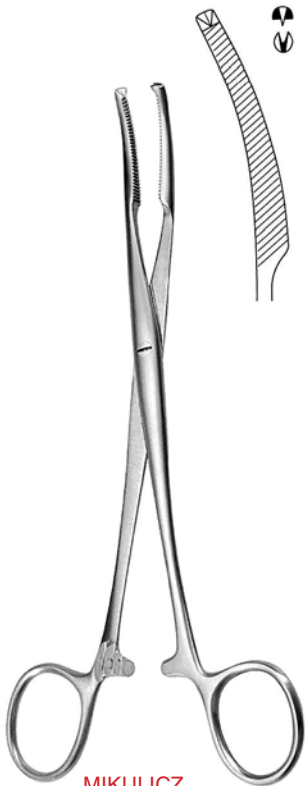

**MIKULICZ**

20.0 cm **GD09.551.20**

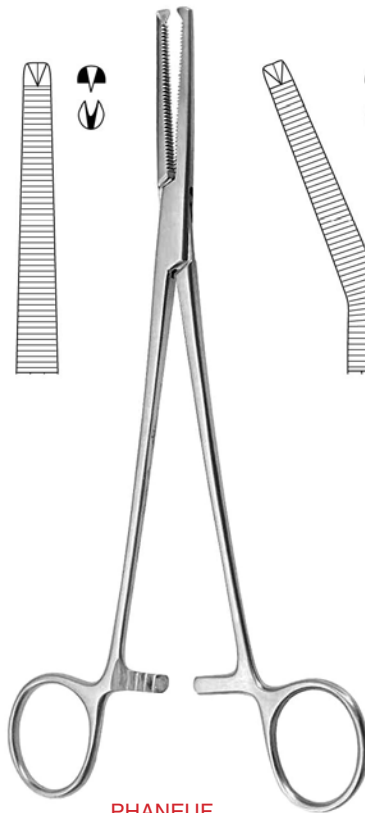

**PHANEUF**

**GD09.554.21** 21.0 cm **GD09.555.21**

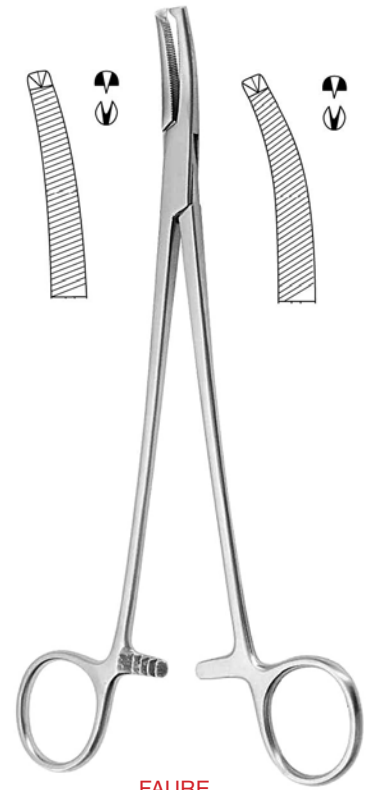

**FAURE**

**GD09.561.20** 20.0 cm **GD09.563.20**





Hysterectomy Forceps  
Hysterektomie-Klemmen  
Pinces à hysterectomie  
Pinzas para hysterectomía  
Pinze per isterectomia

**GRAND**  
DEVICES  
The Grand Instruments Company

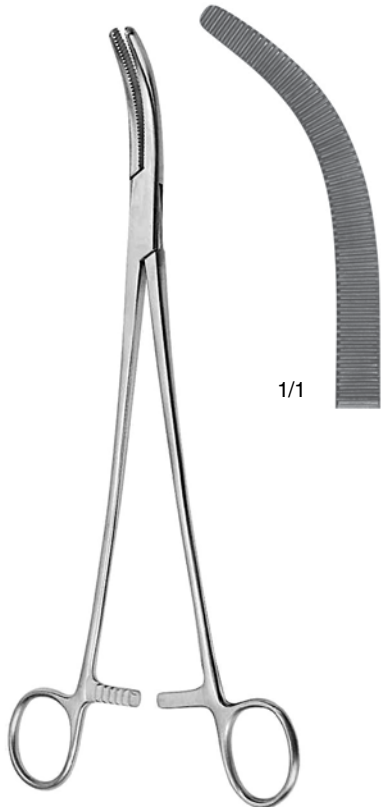

**WERTHEM**  
25.0 cm **GD09.571.25**

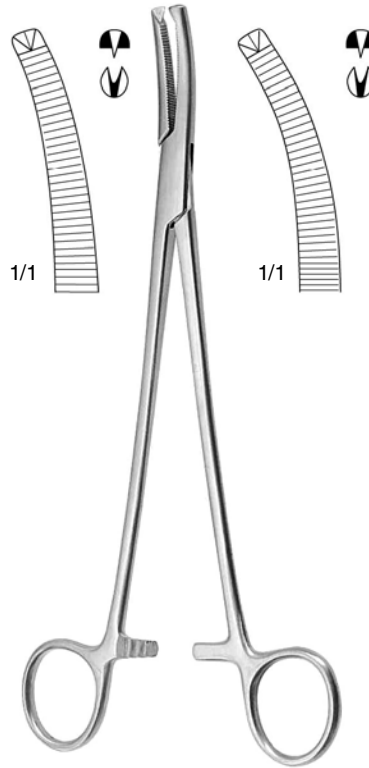

**WERTHEM**  
**GD09.573.22** 22.0 cm  
23.0 cm **GD09.575.23**

1/1



**HEANEY**

1/1  
**GD09.591.20**  
21.5 cm

1/1  
**GD09.593.20**  
21.5 cm



**WERTHEM-CULLEN**  
21.5 cm **GD09.579.21**

Tubing Clamps  
Schlauchklemmen  
Pinces serre-tubes  
Pinzas cierra-tubos  
Pinze serretubi

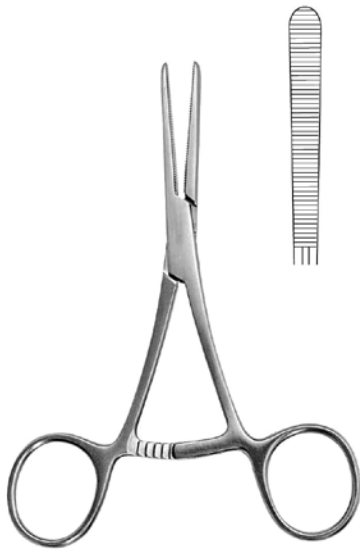

**WEISS**

14.5 cm **GD09.702.14**



**MURPHY**

**GD09.710.15 - GD09.710.20**



**GD09.710.15**  
15.0 cm



**GD09.710.18**  
18.0 cm



**GD09.710.20**  
20.0 cm



**PRESBYTERIAN HOSPITAL**

16.0 cm **GD09.704.16**  
18.0 cm **GD09.704.18**



**GD09.712.15 - GD09.712.20**



**GD09.712.15**  
15.0 cm

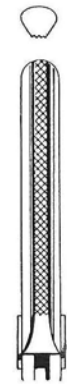

**GD09.712.18**  
18.0 cm



**GD09.712.20**  
20.0 cm



Tube milking rollers  
Rollenklemmen  
Pince à rouleaux  
Pinzas con rodillo  
Pinze con rotoli

**GRAND**  
DEVICES  
*The Grand Instruments Company*



**GUNNER-HEY**  
18.5 cm **GD09.722.18**



**BROMPTON**  
15 cm **GD09.724.15**

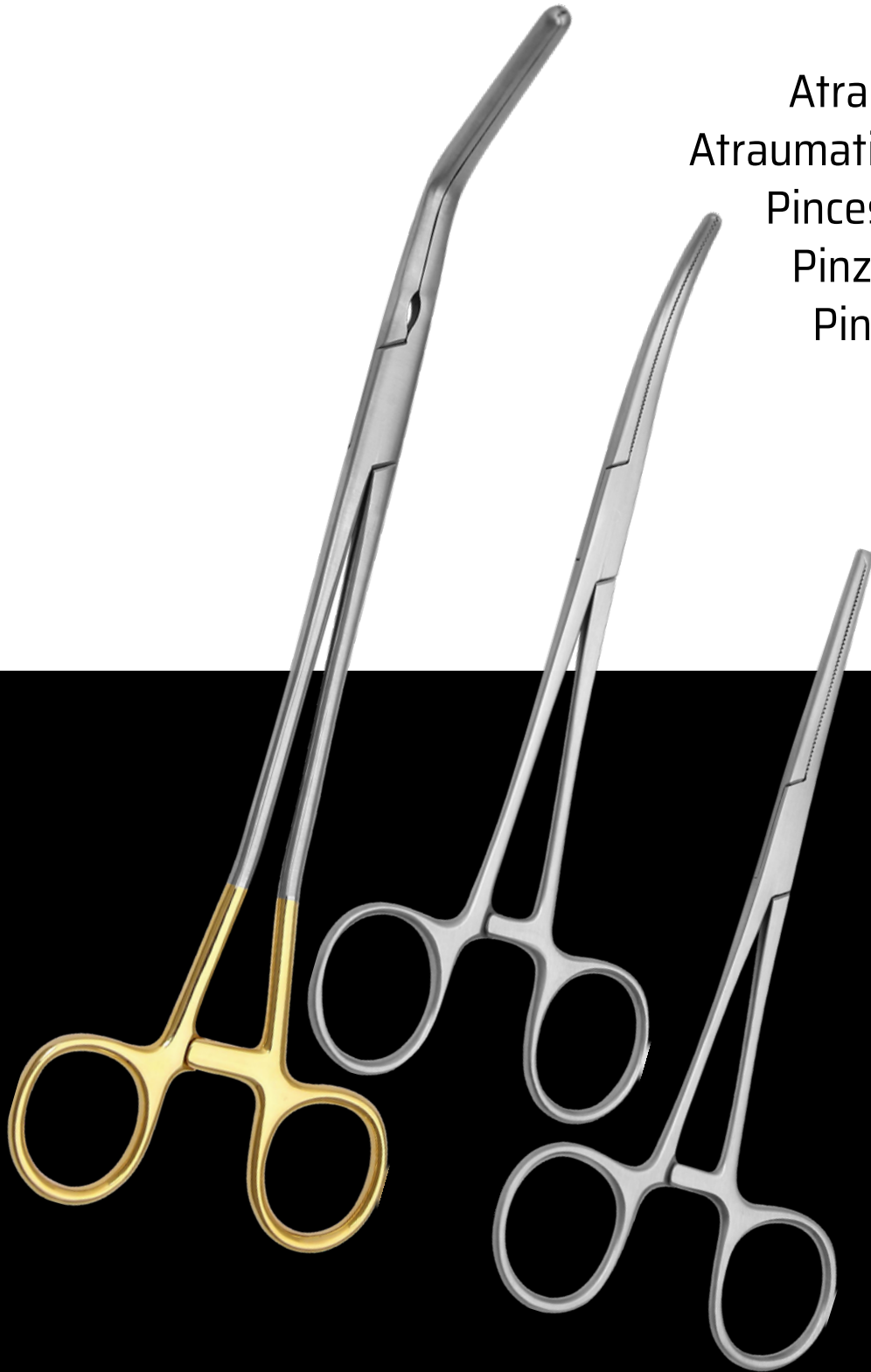

Atraumatic Forceps  
Atraumatische Klemmen  
Pinces atraumatique  
Pinzas atraumático  
Pinze atraumatico  
无创钳

**GD10**



Atraumatic Hemostatic Forceps  
 Atraumatische Gefäßklemmen  
 Pinces hémostatiques atraumatiques  
 Pinzas hemostáticas atraumáticas  
 Pinze emostatiche atraumatiche

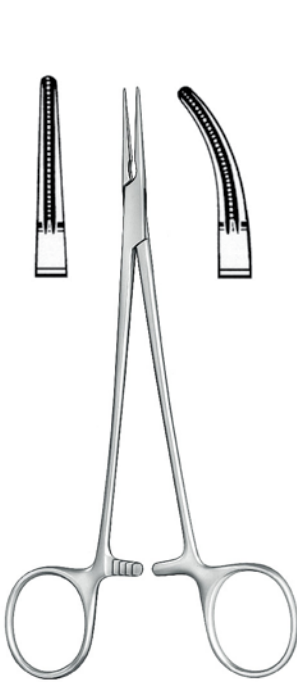

**HALSTEAD-MOSQUITO**

GD10.080.12 12.0 cm    GD10.081.12  
 GD10.080.15 15.0 cm    GD10.081.15

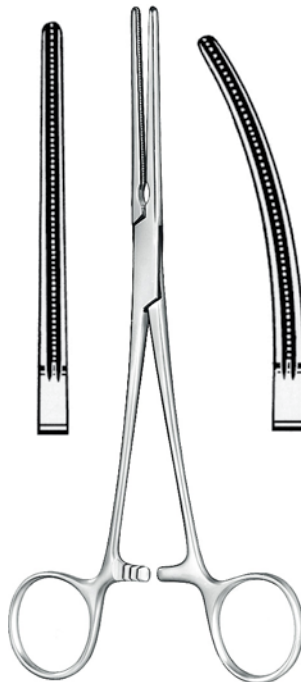

**PEAN**

GD10.082.14 14.0 cm    GD10.083.14  
 GD10.082.16 16.0 cm    GD10.083.16  
 GD10.082.18 18.0 cm    GD10.083.18  
 GD10.082.20 20.0 cm    GD10.083.20

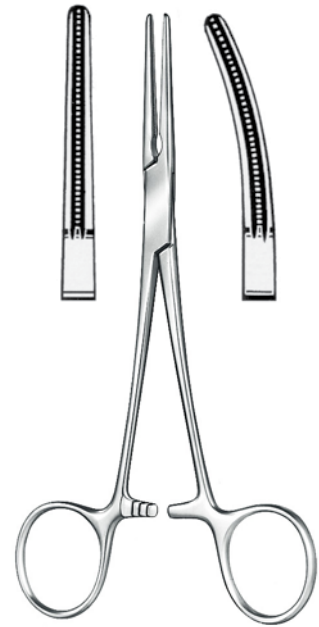

**RANKIN**

GD10.084.16 16.0 cm    GD10.085.16

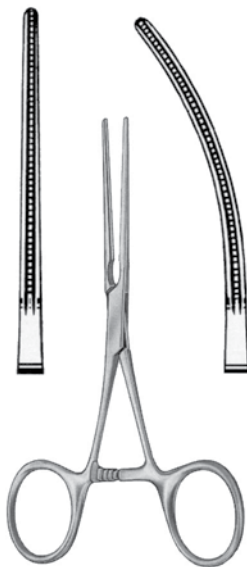

**DE BAKEY**

GD10.102.12 12.0 cm    GD10.103.12



**DE BAKEY**

12.0 cm    GD10.111.12



**DE BAKEY**

12.0 cm    GD10.113.12



**DE BAKEY**

12.0 cm    GD10.121.12

Atraumatic Hemostatic Forceps  
Atraumatische Gefäßklemmen  
Pinces hémostatiques atraumatiques  
Pinzas hemostáticas atraumáticas  
Pinze emostatiche atraumatiche



LEES

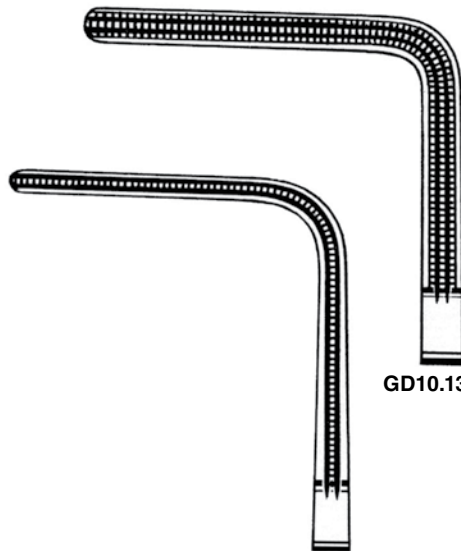

GD10.131.25

GD10.131.23

Bronchus Forceps  
Bronchusklemmen  
Pinces-Clamps à Bronches  
Pinzas clamps bronquiales  
Pinze per bronchi



LEES

25.0 cm GD10.133.25



Atraumatic Hemostatic Forceps  
Atraumatische Gefäßklemmen  
Pinces hémostatiques atraumatiques  
Pinzas hemostáticas atraumáticas  
Pinze emostatiche atraumatiche

**GRAND**  
DEVICES  
The Grand Instruments Company

Coarctation Clamps  
Coarctationsklemmen  
Pinces pour coarctation  
Pinzas para coarctación  
Pinze per coarctazione

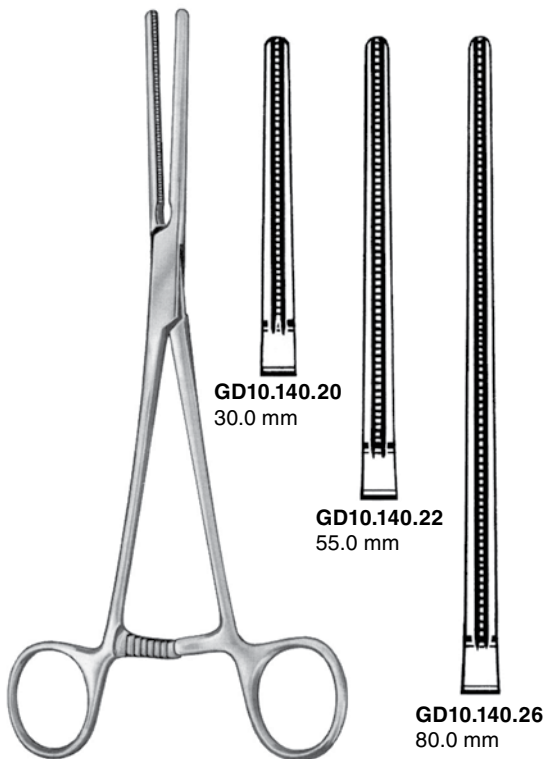

**POTTS**

20.0 cm **GD10.140.20**  
22.5 cm **GD10.140.22**  
26.0 cm **GD10.140.26**

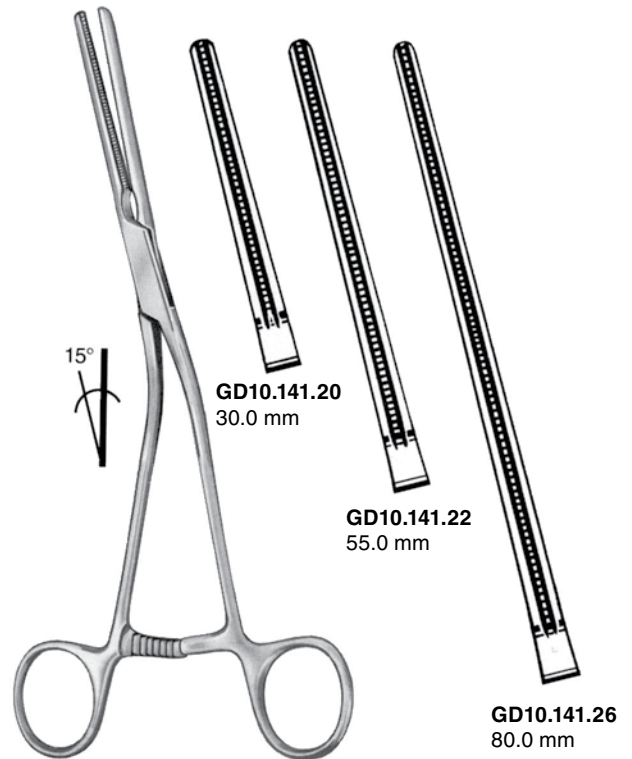

**GLOVER**

20.0 cm **GD10.141.20**  
22.5 cm **GD10.141.22**  
26.0 cm **GD10.141.26**

Atraumatic Hemostatic Forceps  
 Atraumatische Gefäßklemmen  
 Pincés hémostatiques atraumatiques  
 Pinzas hemostáticas atraumáticas  
 Pinze emostatiche atraumatiche



**POTTS / GLOVER**

21.0 cm **GD10.151.21**  
 24.0 cm **GD10.151.24**

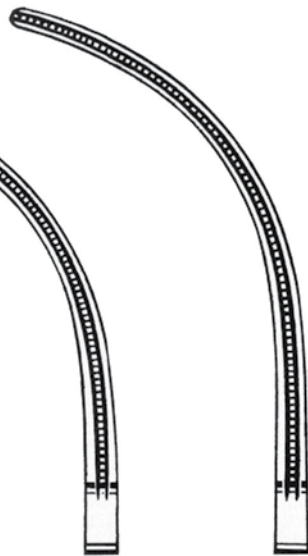

**GD10.151.21**

**GD10.151.24**

Anastomosis Clamps  
 Anastomosenklemmen  
 Pincés à anastomose  
 Pinzas para anastomosis  
 Pinze per anastomosi



**GLOVER**

18.0 cm **GD10.153.18**  
 22.0 cm **GD10.153.22**

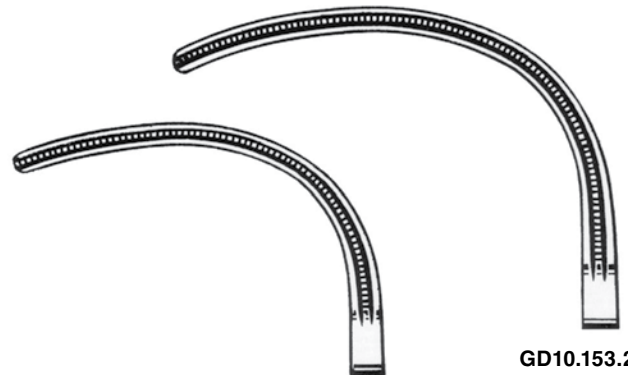

**GD10.153.18**

**GD10.153.22**





Atraumatic Hemostatic Forceps  
 Atraumatische Gefäßklemmen  
 Pincés hémostatiques atraumatiques  
 Pinzas hemostáticas atraumáticas  
 Pinze emostatiche atraumatiche

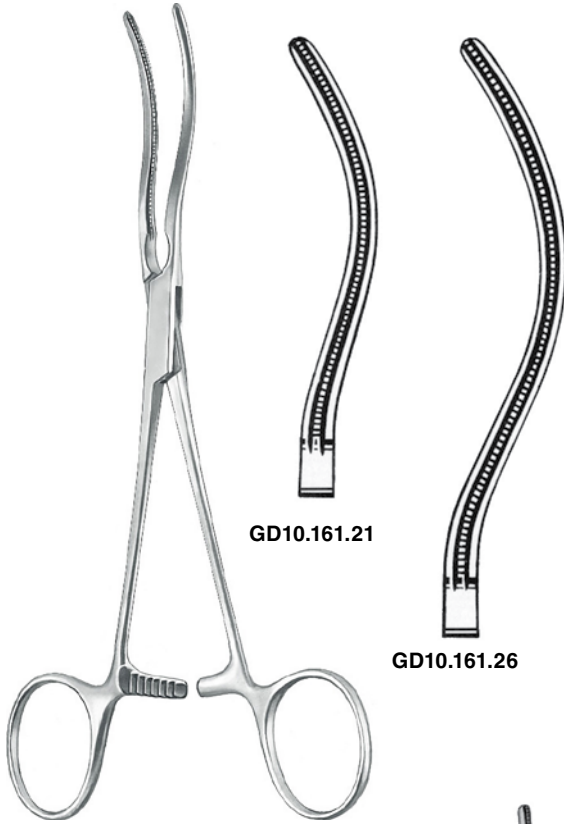

Vascular Clamps Spoon Shaped  
 Vascularklemme löffelförmig  
 Pince vasculaire forme cuiller  
 Pinza vascular forma cuchara  
 Pinza vascolare forma cucchiaino

**GLOVER**  
 21.0 cm **GD10.161.21**  
 26.0 cm **GD10.161.26**

Peripheral Vascular Forceps  
 Peripher-Vascularklemmen  
 Pincés vasculaires périph.  
 Pinzas vasculares perif.  
 Pinze vascolari perif.

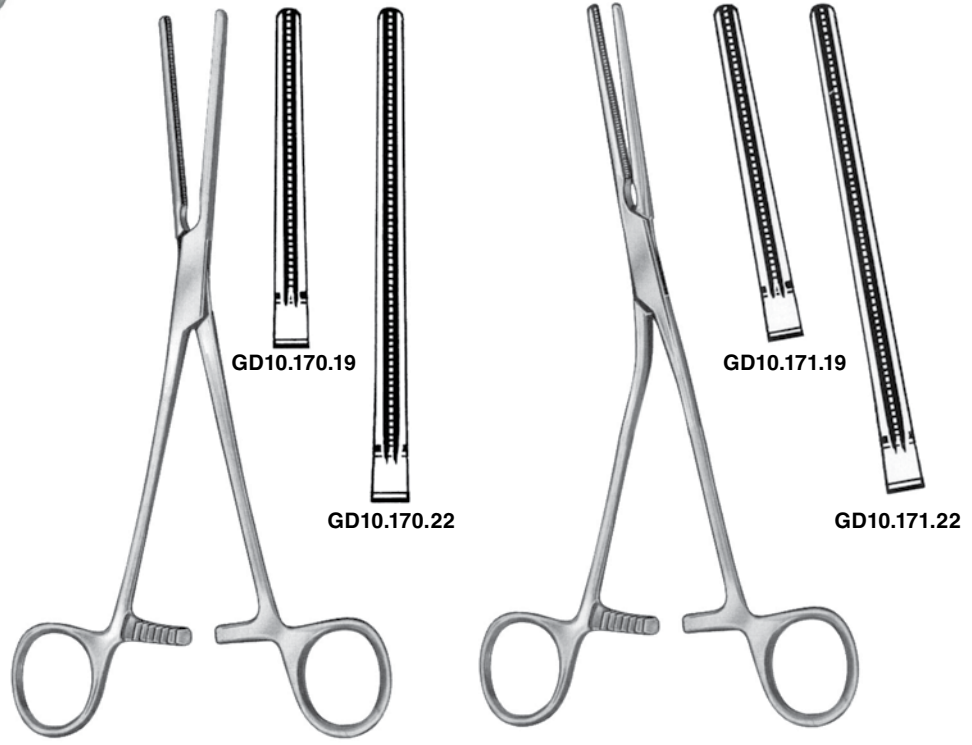

**DE BAKEY**  
 18.0 cm **GD10.170.19**  
 22.0 cm **GD10.170.22**

**DE BAKEY**  
 18.0 cm **GD10.171.19**  
 22.0 cm **GD10.171.22**

Atraumatic Hemostatic Forceps  
 Atraumatische Gefäßklemmen  
 Pinces hémostatiques atraumatiques  
 Pinzas hemostáticas atraumáticas  
 Pinze emostatiche atraumatiche



Atraumatic Multi-Purpose Clamps  
 Atraumatische Mehrzweckklemmen  
 Pinces-clamps polyvalentes  
 Pinzas clamps para usos varios  
 Pinze atraumatiche per diversi usi

DARDIK

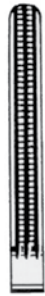

0°

14.0 cm --  
 15.0 cm **GD10.172.00**

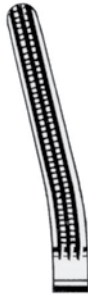

15°

--  
**GD10.172.15**



30°

--  
**GD10.172.30**



45°

--  
**GD10.172.45**

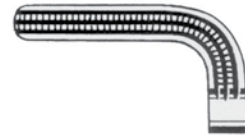

90°

**GD10.172.90**  
 --

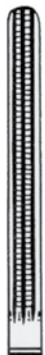

0°

16.0 cm --  
 17.0 cm **GD10.174.00**

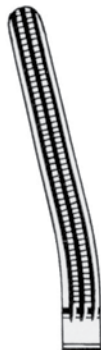

15°

--  
**GD10.174.15**

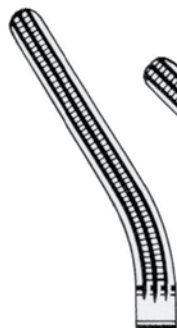

30°

--  
**GD10.174.30**

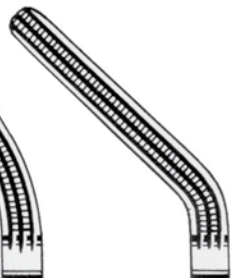

45°

--  
**GD10.174.45**



90°

**GD10.174.90**  
 --



Atraumatic Hemostatic Forceps  
 Atraumatische Gefäßklemmen  
 Pincés hémostatiques atraumatiques  
 Pinzas hemostáticas atraumáticas  
 Pinze emostatiche atraumatiche

**GRAND**  
 DEVICES  
 The Grand Instruments Company

Peripheral Vascular Forceps  
 Peripher-Vascularklemmen  
 Pincés vasculaires périph.  
 Pinzas vasculares perif.  
 Pinze vascolari perif.



**LELAND-JONES**

19.0 cm **GD10.181.19**



**DE BAKEY**

26.0 cm **GD10.181.26**

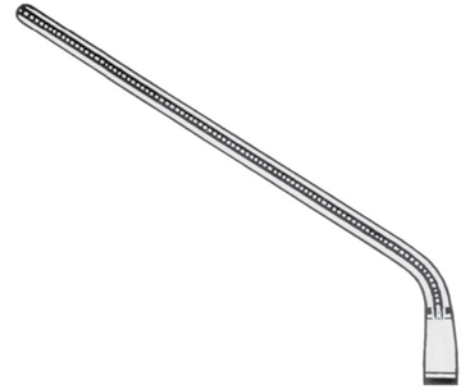

**DE BAKEY**

19.0 cm **GD10.183.19**  
 20.0 cm **GD10.183.20**

**GD10.183.19**  
 19.0 cm

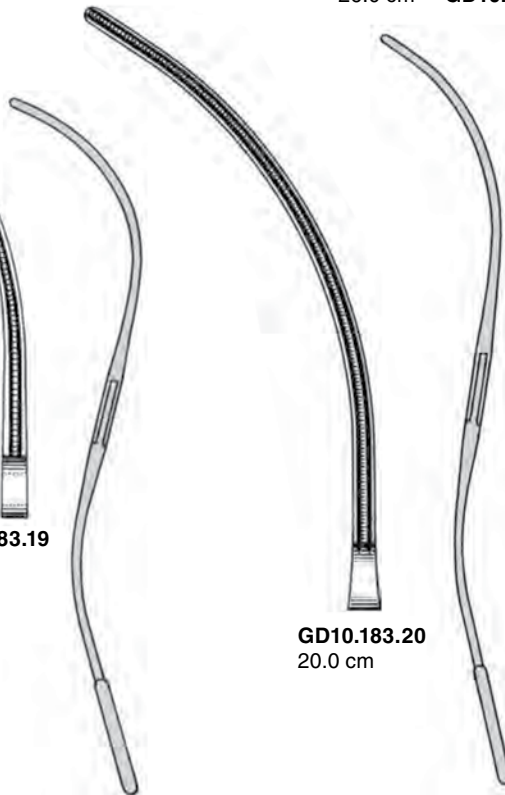

**GD10.183.20**  
 20.0 cm



**DE BAKEY**

16.0 cm **GD10.191.16**

Atraumatic Hemostatic Forceps  
 Atraumatische Gefäßklemmen  
 Pincés hémostatiques atraumatiques  
 Pinzas hemostáticas atraumáticas  
 Pinze emostatiche atraumatiche



**GD10.196.15**  
15.0 cm



**GD10.196.18**  
18.0 cm



**BAINBRIDGE**



**GD10.197.15**  
15.0 cm



**GD10.197.18**  
18.0 cm

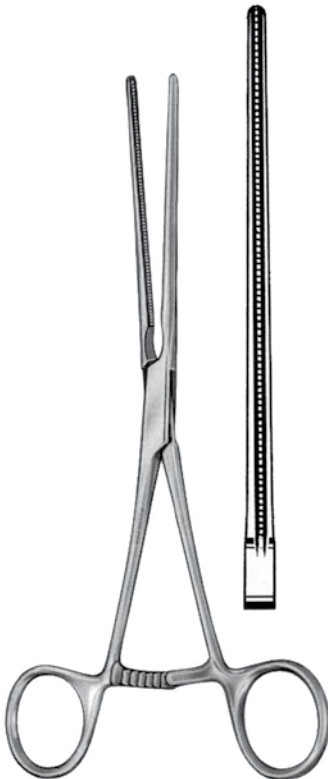

**LELAND-JONES**  
19.0 cm **GD10.202.19**

Peripheral Vascular Forceps  
 Peripher-Vascularklemmen  
 Pincés vasculaires périph.  
 Pinzas vasculares perif.  
 Pinze vascolari perif.



**GD10.203.19**  
19.0 cm

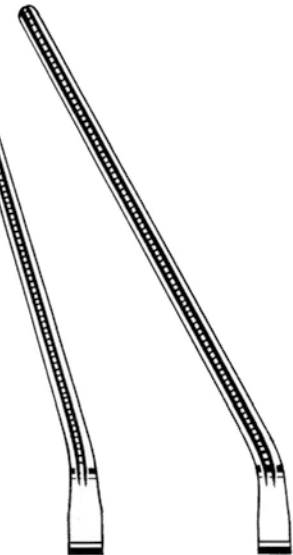

**GD10.205.19**  
19.0 cm

**LELAND-JONES**



Atraumatic Hemostatic Forceps  
Atraumatische Gefäßklemmen  
Pinces hémostatiques atraumatiques  
Pinzas hemostáticas atraumáticas  
Pinze emostatiche atraumatiche

**GRAND**  
DEVICES  
The Grand Instruments Company

Aortic Clamp  
Aortaklemmen  
Pince-clamp à aorte  
Pinza clamp para aorta  
Pinza per aorta



LIDDLE

27.0 cm **GD10.209.27**

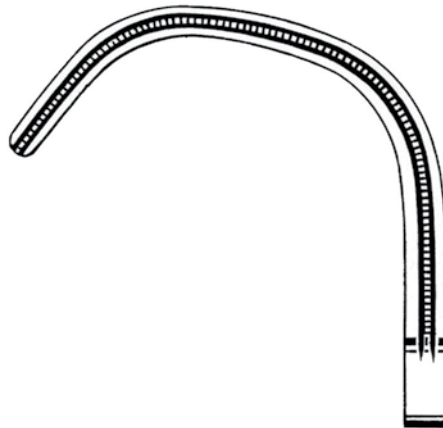

Aorta-Anastomosis Clamps  
Aorta-Anastomosenklemmen  
Pinces-clamps pour anastomoses d'aorte  
Pinzas clamps para anastomosis de aorta  
Pinze aortiche

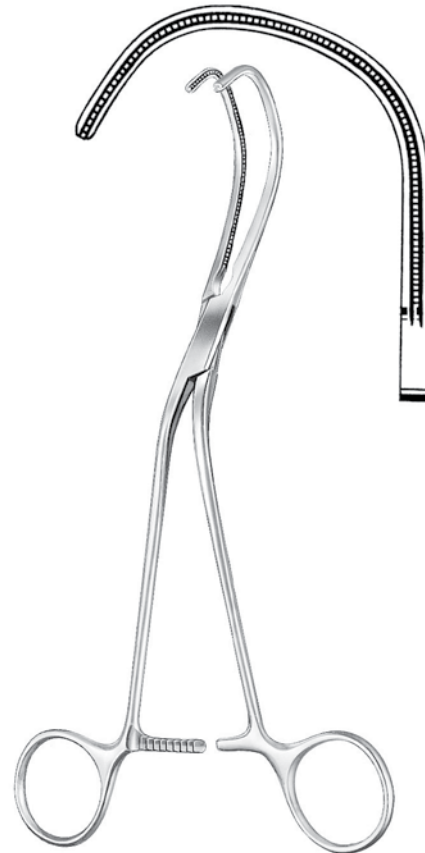

LAMBERT KAY

20.0 cm **GD10.211.20**

Atraumatic Hemostatic Forceps  
Atraumatische Gefäßklemmen  
Pinces hémostatiques atraumatiques  
Pinzas hemostáticas atraumáticas  
Pinze emostatiche atraumatiche



Iliac Clamp  
Iliaca-Klemme  
Pince-clamp à iliaque  
Pinza clamp para iliaca  
Pinza per iliaca



LAMBERT KAY

20.0 cm **GD10.213.20**

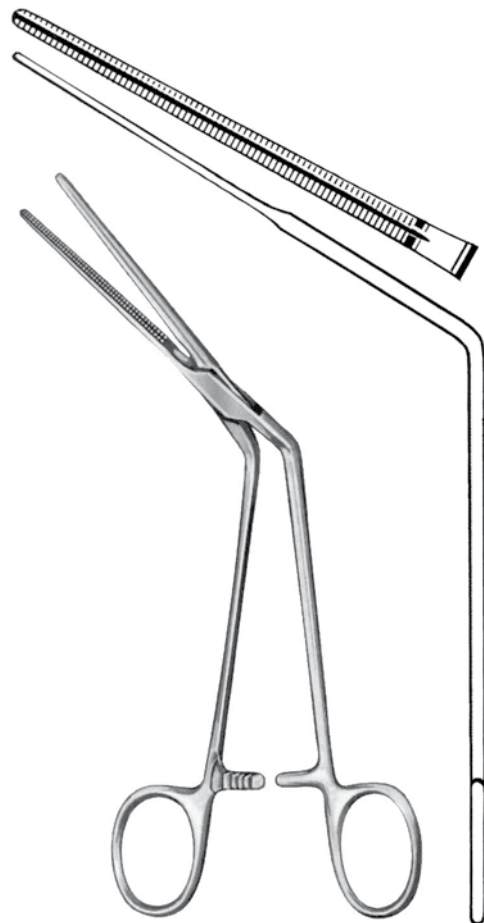

DE BAKEY

20.0 cm **GD10.215.20**



Atraumatic Hemostatic Forceps  
Atraumatische Gefäßklemmen  
Pinces hémostatiques atraumatiques  
Pinzas hemostáticas atraumáticas  
Pinze emostatiche atraumatiche

**GRAND**  
DEVICES  
*The Grand Instruments Company*

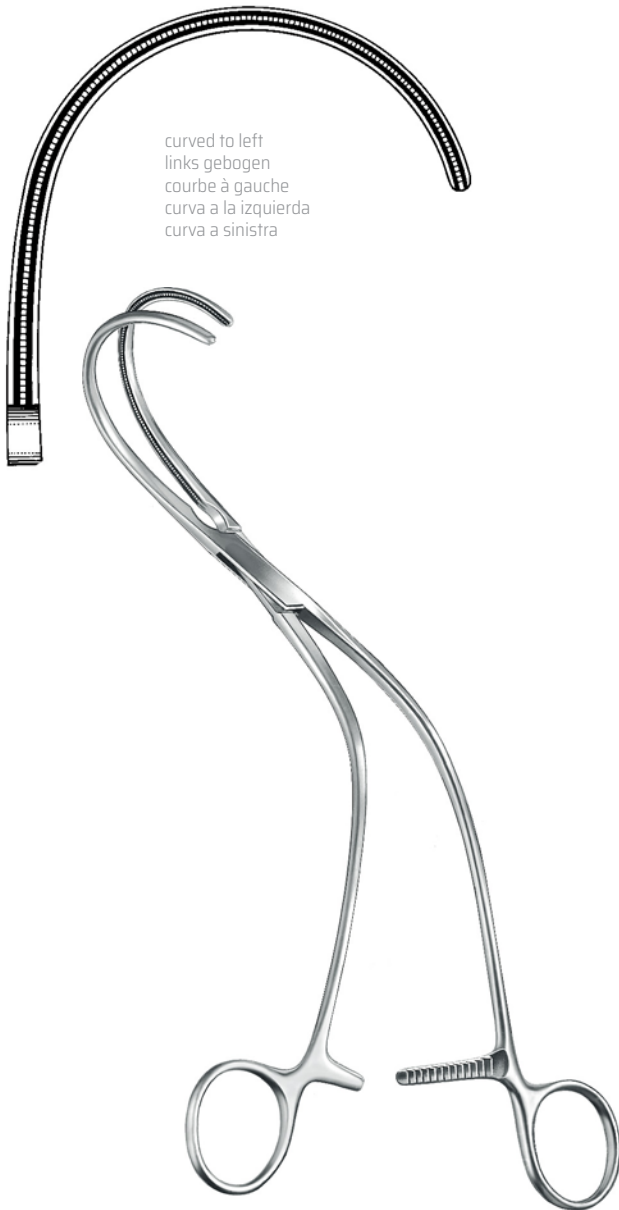

curved to left  
links gebogen  
courbe à gauche  
curva a la izquierda  
curva a sinistra

**WEBER**

26.0 cm **GD10.217.26**

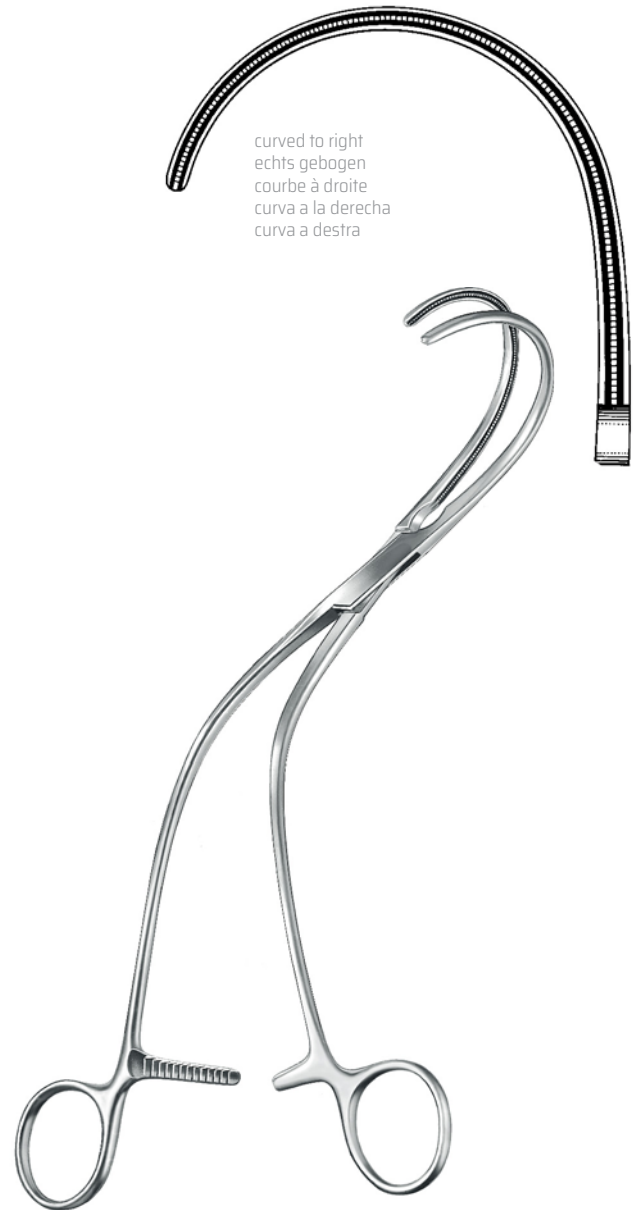

curved to right  
rechts gebogen  
courbe à droite  
curva a la derecha  
curva a destra

**WEBER**

26.0 cm **GD10.219.26**



Atraumatic Hemostatic Forceps  
Atraumatische Gefäßklemmen  
Pinces hémostatiques atraumatiques  
Pinzas hemostáticas atraumáticas  
Pinze emostatiche atraumatiche



Aorta-Aneurysm Clamps  
Aorta-Aneurysma-Klemmen  
Pinces-clamps pour aneurysme d'aorte  
Pinzas clamps para aneurisma de aorta  
Pinze per aneurisma di aorta

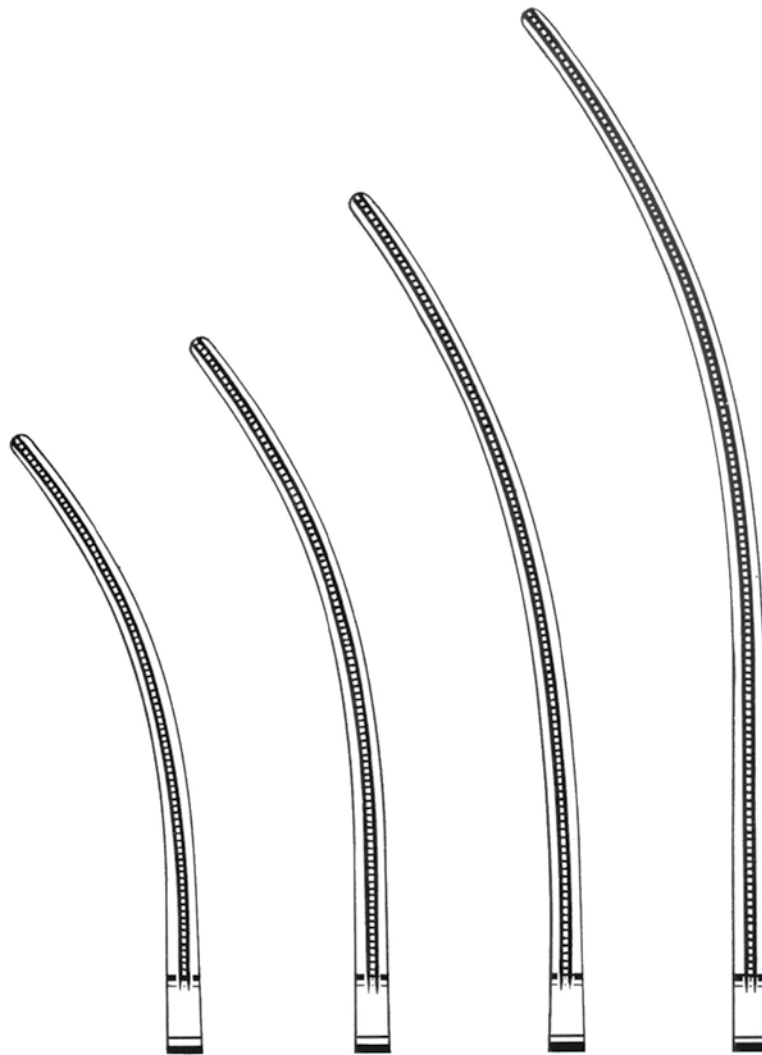

DE BAKEY

GD10.221.24  
24.0 cm

GD10.221.27  
27.0 cm

GD10.221.31  
31.0 cm

GD10.221.35  
35.0 cm





Atraumatic Hemostatic Forceps  
Atraumatische Gefäßklemmen  
Pinces hémostatiques atraumatiques  
Pinzas hemostáticas atraumáticas  
Pinze emostatiche atraumatiche



Aorta-Aneurysm Clamps  
Aorta-Aneurysma-Klemmen  
Pinces-clamps pour aneurysme d'aorte  
Pinzas clamps para aneurisma de aorta  
Pinze per aneurisma di aorta



DE BAKEY BAHNSON



GD10.223.24  
24.0 cm

GD10.223.25  
25.0 cm

GD10.223.26  
26.0 cm

Atraumatic Hemostatic Forceps  
Atraumatische Gefäßklemmen  
Pinces hémostatiques atraumatiques  
Pinzas hemostáticas atraumáticas  
Pinze emostatiche atraumatiche



Aorta-Aneurysm Clamps  
Aorta-Aneurysma-Klemmen  
Pinces-clamps pour aneurysme d'aorte  
Pinzas clamps para aneurisma de aorta  
Pinze per aneurisma di aorta

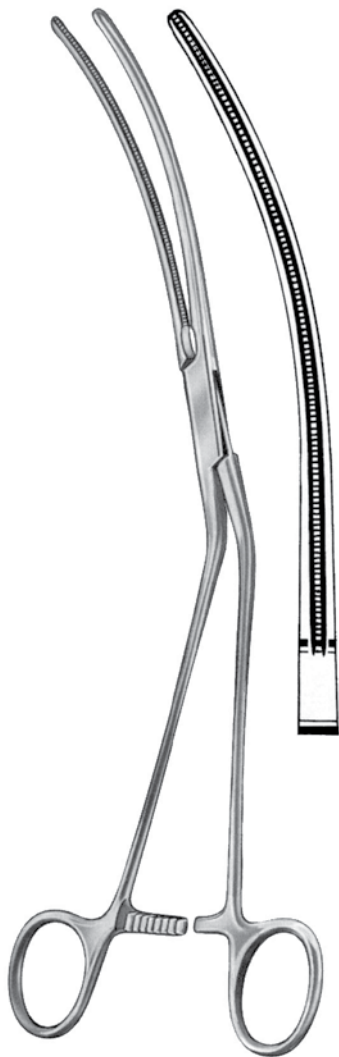

DE BAKEY  
28.0 cm **GD10.225.28**

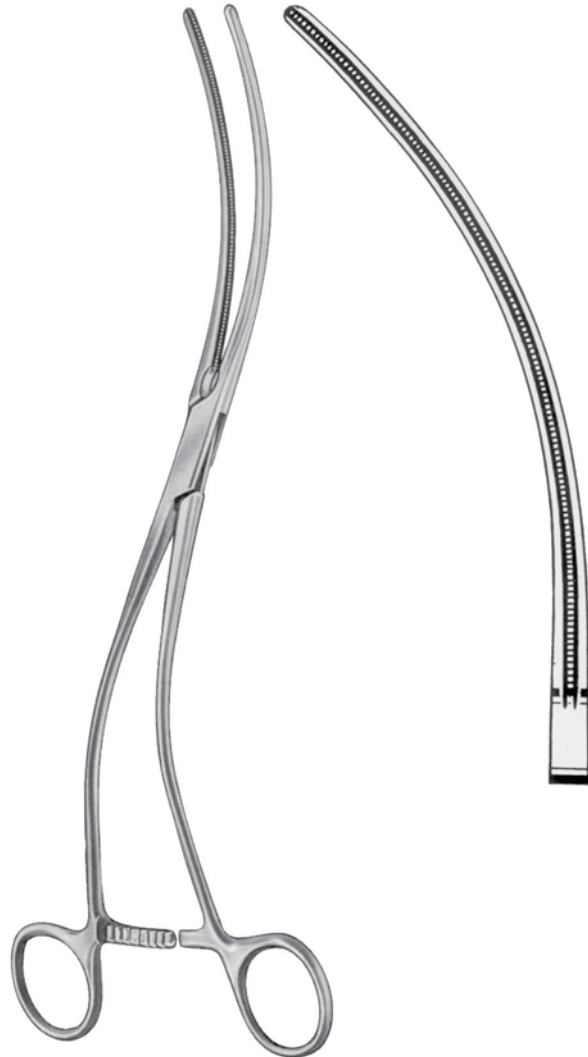

DE BAKEY  
28.0 cm **GD10.227.28**



Atraumatic Hemostatic Forceps  
Atraumatische Gefäßklemmen  
Pinces hémostatiques atraumatiques  
Pinzas hemostáticas atraumáticas  
Pinze emostatiche atraumatiche

**GRAND**  
DEVICES  
*The Grand Instruments Company*

Atraumatic Multi-Purpose Clamps  
Atraumatische Mehrzweckklemmen  
Pinces-clamps polyvalentes  
Pinzas clamps para usos varios  
Pinze atraumatiche per diversi usi



DE BAKEY MORRIS

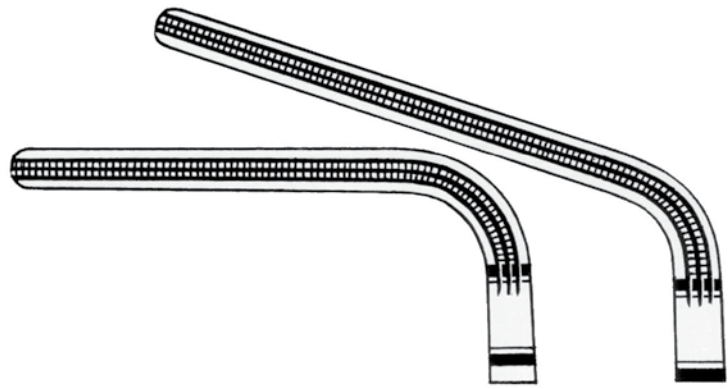

GD10.229.18  
18.0 cm

GD10.229.20  
20.0 cm

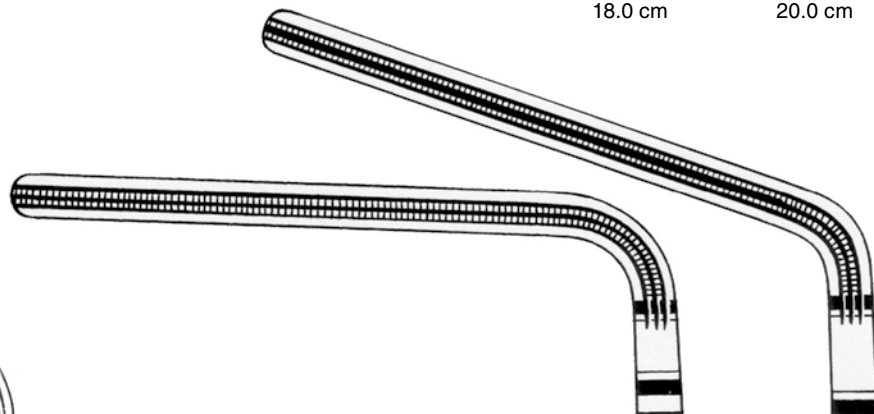

GD10.229.23  
23.0 cm

GD10.229.25  
25.0 cm

Atraumatic Hemostatic Forceps  
Atraumatische Gefäßklemmen  
Pinces hémostatiques atraumatiques  
Pinzas hemostáticas atraumáticas  
Pinze emostatiche atraumatiche



Atraumatic Multi-Purpose Clamps  
Atraumatische Mehrzweckklemmen  
Pinces-clamps polyvalentes  
Pinzas clamps para usos varios  
Pinze atraumatiche per diversi usi



**GD10.231.18**  
18.0 cm



**GD10.231.21**  
21.0 cm

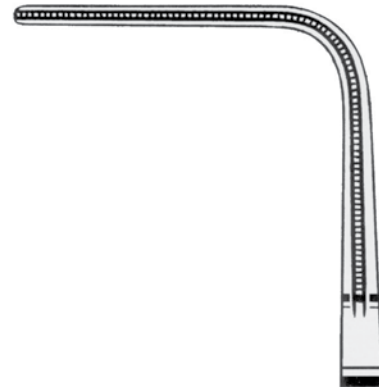

**GD10.231.23**  
23.0 cm



**GD10.231.27**  
27.0 cm



**DE BAKEY**



Atraumatic Hemostatic Forceps  
Atraumatische Gefäßklemmen  
Pinces hémostatiques atraumatiques  
Pinzas hemostáticas atraumáticas  
Pinze emostatiche atraumatiche

**GRAND**<sup>®</sup>  
DEVICES  
*The Grand Instruments Company*

Aorta-Aneurysm Clamps  
Aorta-Aneurysma-Klemmen  
Pinces-clamps pour aneurysme d'aorte  
Pinzas clamps para aneurisma de aorta  
Pinze per aneurisma di aorta



DE BAKEY

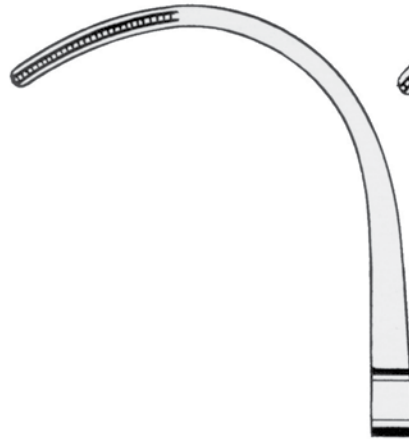

**GD10.241.25**  
25.0 cm

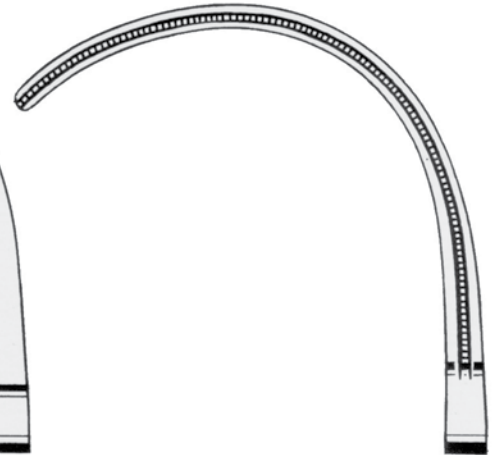

**GD10.241.26**  
26.0 cm

Atraumatic Hemostatic Forceps  
Atraumatische Gefäßklemmen  
Pinces hémostatiques atraumatiques  
Pinzas hemostáticas atraumáticas  
Pinze emostatiche atraumatiche



Bronchus Clamps  
Bronchus-Klemmen  
Pinces pour les bronches  
Pinzas bronquiales  
Pinze per bronchi

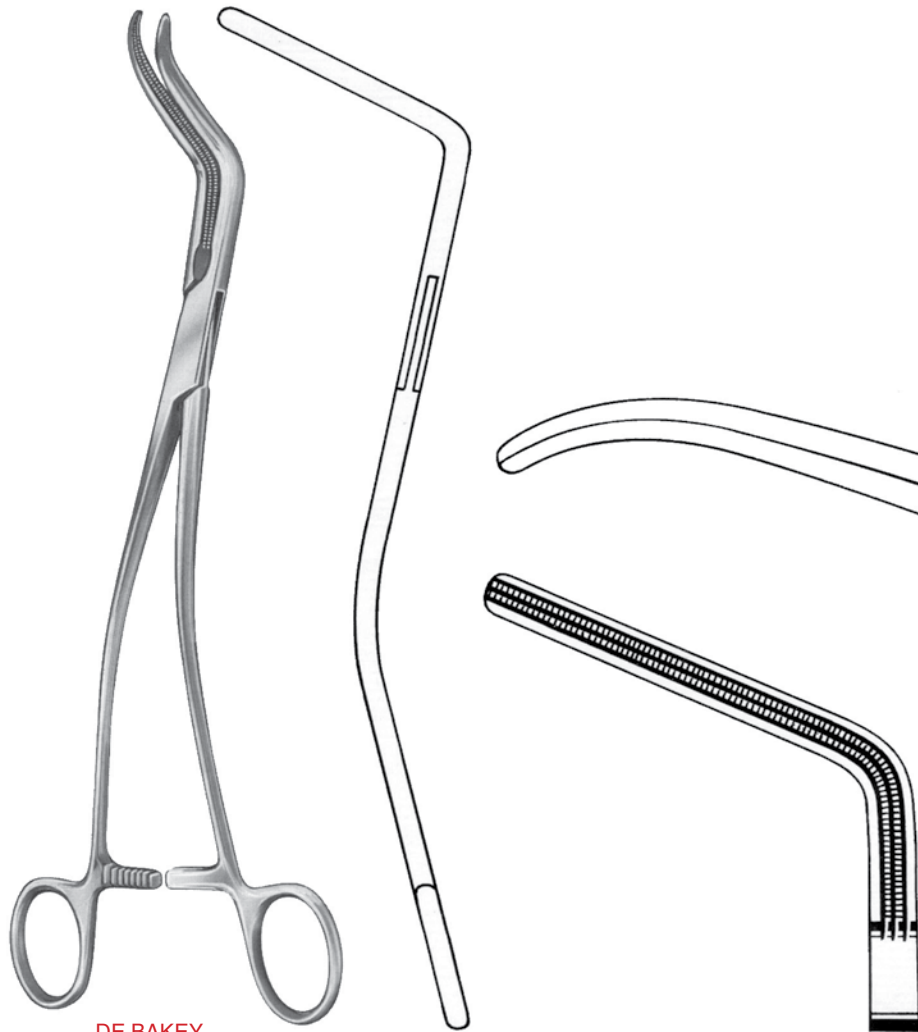

DE BAKEY

27.0 cm GD10.247.27



Atraumatic Hemostatic Forceps  
Atraumatische Gefäßklemmen  
Pinces hémostatiques atraumatiques  
Pinzas hemostáticas atraumáticas  
Pinze emostatiche atraumatiche

**GRAND**  
DEVICES  
*The Grand Instruments Company*



DE BAKEY

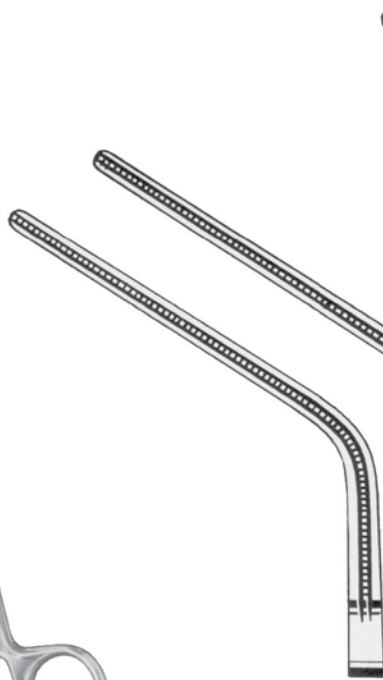

GD10.251.20  
20.0 cm



GD10.251.24  
24.0 cm



GD10.251.25  
25.0 cm

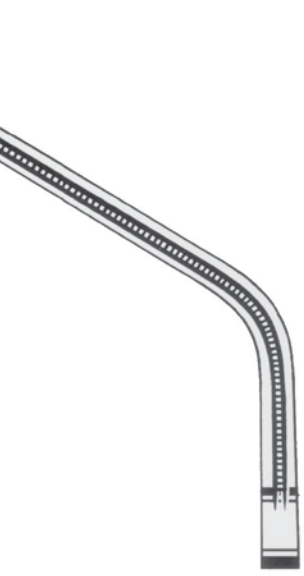

GD10.251.30  
30.0 cm



SATINSKY



GD10.253.20  
20.0 cm

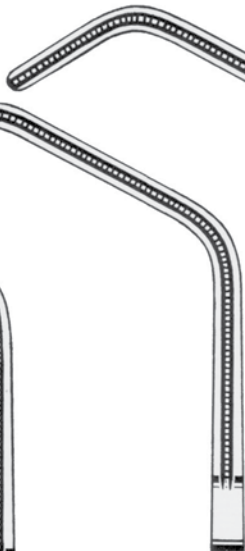

GD10.253.24  
24.0 cm



GD10.253.25  
25.0 cm



GD10.253.26  
26.0 cm

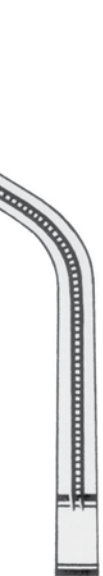

GD10.253.27  
27.0 cm

Atraumatic Hemostatic Forceps  
 Atraumatische Gefäßklemmen  
 Pinces hémostatiques atraumatiques  
 Pinzas hemostáticas atraumáticas  
 Pinze emostatiche atraumatiche



Applying for Clips  
 Anlegezange für Clips  
 Applicateur pour clips  
 Pinza para aplicar clips  
 Applicatore per clips

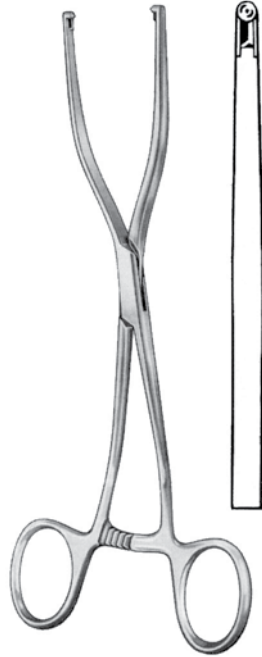

**EDWARDS**  
**GD10.258.00**

Clips  
 Clips  
 Clips  
 Clips  
 Clips



**EDWARDS**  
 06.0 mm **GD10.258.06**  
 12.0 mm **GD10.258.12**



**WYLIE**

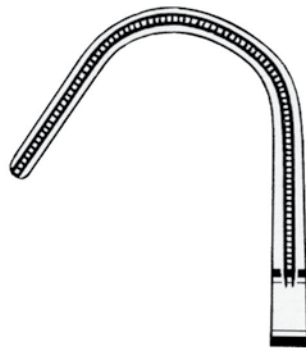

**GD10.259.01**  
 21.0 cm  
 Fig.1

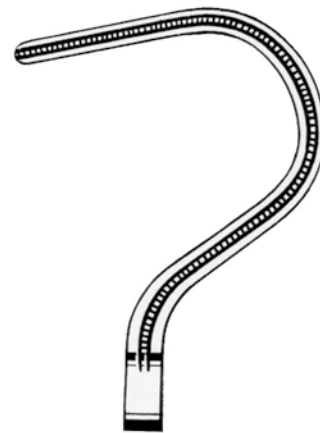

**GD10.259.02**  
 22.0 cm  
 Fig.2





Atraumatic Hemostatic Forceps  
Atraumatische Gefäßklemmen  
Pinces hémostatiques atraumatiques  
Pinzas hemostáticas atraumáticas  
Pinze emostatiche atraumatiche

**GRAND**<sup>®</sup>  
DEVICES  
*The Grand Instruments Company*



DE BAKEY SATINSKY

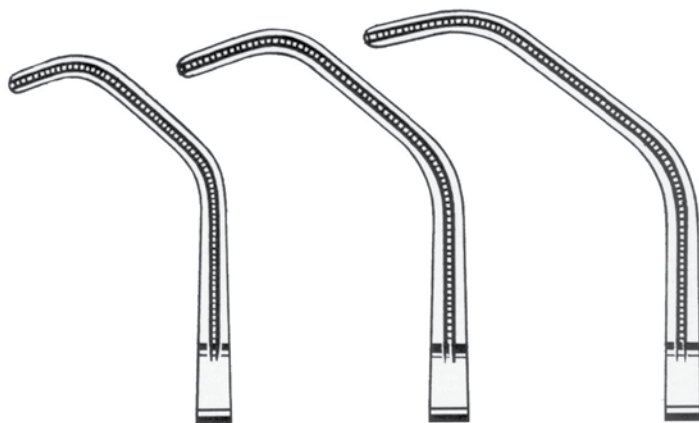

**GD10.261.23**  
23.0 cm  
Fig.1

**GD10.261.24**  
24.0 cm  
Fig.2

**GD10.261.25**  
25.0 cm  
Fig.3

Atraumatic Hemostatic Forceps  
Atraumatische Gefäßklemmen  
Pinces hémostatiques atraumatiques  
Pinzas hemostáticas atraumáticas  
Pinze emostatiche atraumatiche



Auricle Clamps  
Aurikelklemmen  
Pinces auriculaires  
Pinzas para aurícula  
Pinze ventricolari



HARKEN

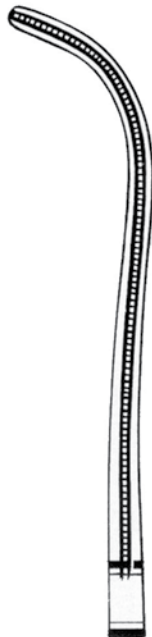

GD10.263.25  
25.0 cm  
Fig.1



GD10.265.24  
24.0 cm  
Fig.2

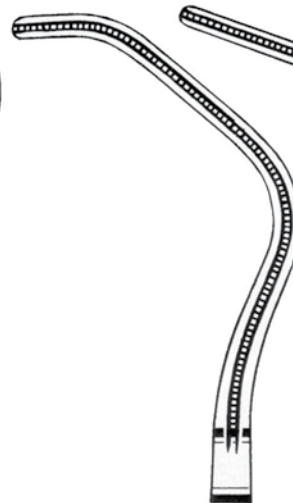

GD10.267.24  
24.0 cm  
Fig.3

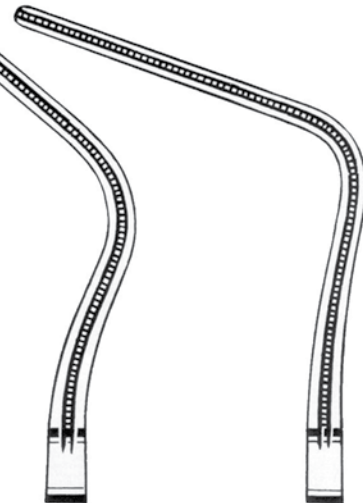

GD10.269.24  
24.0 cm  
Fig.4



Atraumatic Hemostatic Forceps  
Atraumatische Gefäßklemmen  
Pinces hémostatiques atraumatiques  
Pinzas hemostáticas atraumáticas  
Pinze emostatiche atraumatiche

**GRAND**  
DEVICES  
*The Grand Instruments Company*

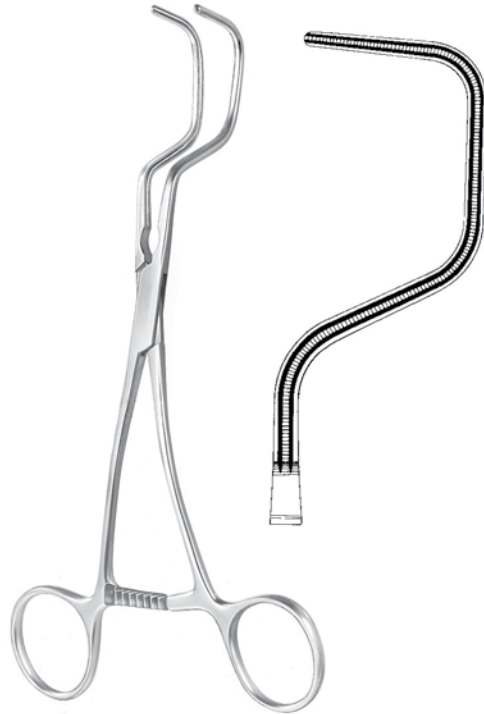

Peripheal Vascular Clamps  
Peripheal-Gefäßklemmen  
Pinces-clamps, vasculaires périphériques  
Pinzas para vasos periféricos  
Pinze vascolari periferali

**DALE**

18.0 cm **GD10.271.18**

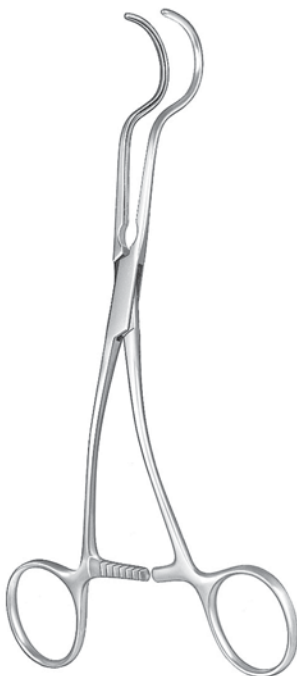

**DALE**



**GD10.273.17**  
17.0 cm



**GD10.273.18**  
18.0 cm



**GD10.273.19**  
19.0 cm

Atraumatic Hemostatic Forceps  
 Atraumatische Gefäßklemmen  
 Pincers hémostatiques atraumatiques  
 Pinzas hemostáticas atraumáticas  
 Pinze emostatiche atraumatiche

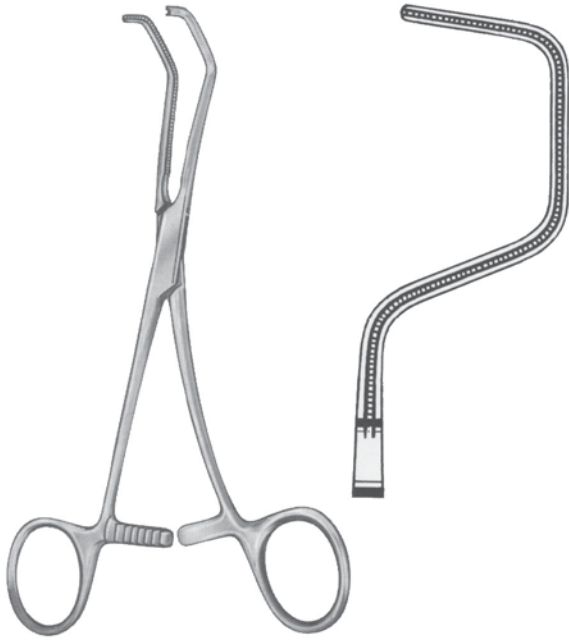

**DE BAKEY**  
 17.0 cm **GD10.281.17**



**BECK**  
 17.0 cm **GD10.283.17**

Dissecting and Ligature Clamps  
 Präparier- und Ligaturklemmen  
 Pincers à dissection et passe-fil  
 Pinzas de disección y para ligaduras  
 Pinze per dissezione e per legature

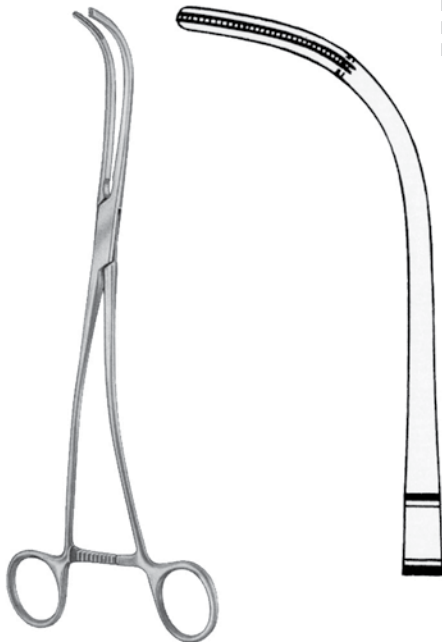

**DE BAKEY**  
 24.0 cm **GD10.285.24**

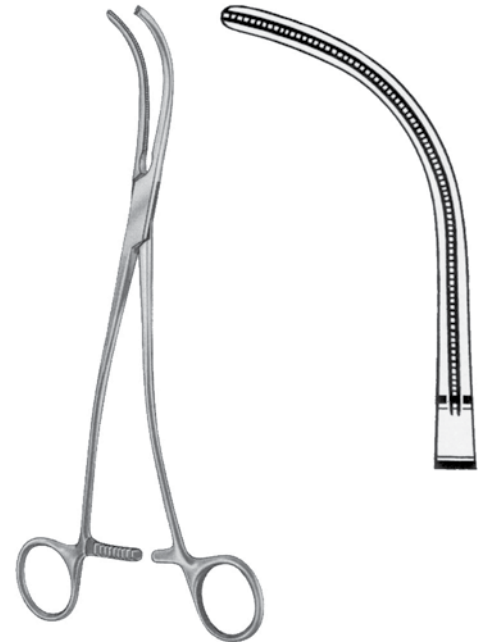

**DE BAKEY**  
 24.0 cm **GD10.287.24**



Atraumatic Hemostatic Forceps  
Atraumatische Gefäßklemmen  
Pinces hémostatiques atraumatiques  
Pinzas hemostáticas atraumáticas  
Pinze emostatiche atraumatiche

**GRAND**  
DEVICES  
*The Grand Instruments Company*

Atraumatic Multi-Purpose Clamps  
Atraumatische Mehrzweckklemmen  
Pinces-clamps polyvalentes  
Pinzas clamps para usos varios  
Pinze atraumatiche per diversi usi



POTTS



GD10.288.21  
21.0 cm



GD10.288.23  
23.0 cm



GD10.288.27  
27.0 cm



GD10.288.31  
31.0 cm

Atraumatic Hemostatic Forceps  
Atraumatische Gefäßklemmen  
Pinces hémostatiques atraumatiques  
Pinzas hemostáticas atraumáticas  
Pinze emostatiche atraumatiche



Atraumatic Multi-Purpose Clamps  
Atraumatische Mehrzweckklemmen  
Pinces-clamps polyvalentes  
Pinzas clamps para usos varios  
Pinze atraumatiche per diversi usi



POTTS



**GD10.289.21**  
21.0 cm

**GD10.289.23**  
23.0 cm

**GD10.289.27**  
27.0 cm

**GD10.289.31**  
31.0 cm



Atraumatic Hemostatic Forceps  
Atraumatische Gefäßklemmen  
Pinces hémostatiques atraumatiques  
Pinzas hemostáticas atraumáticas  
Pinze emostatiche atraumatiche

**GRAND**  
DEVICES  
*The Grand Instruments Company*

Anastomosis Clamps, Pediatric  
Anastomosenklemmen, Kindergrößen  
Pinces à anastomose, pédiatriques  
Pinzas para anastomosis, pediátricas  
Pinze per anastomosi, pediatriche



**DERRA**

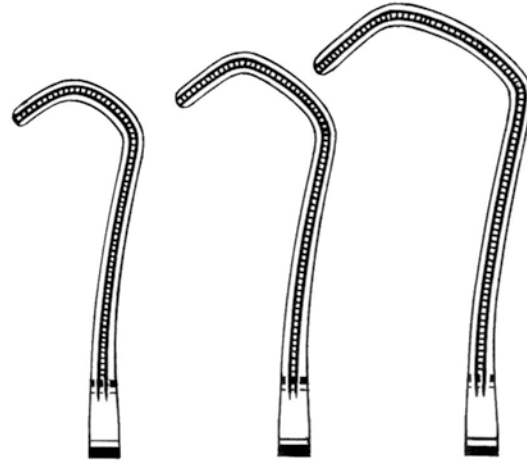

**GD10.291.16**  
16.0 cm

**GD10.291.17**  
17.0 cm

**GD10.291.18**  
18.0 cm



**DE BAKEY**

16.0 cm **GD10.302.16**

Atraumatic Multi-Purpose Clamps  
Atraumatische Mehrzweckklemmen  
Pinces-clamps polyvalentes  
Pinzas clamps para usos varios  
Pinze atraumatiche per diversi usi



**DE BAKEY**

17.0 cm **GD10.302.17**

Atraumatic Hemostatic Forceps  
Atraumatische Gefäßklemmen  
Pinces hémostatiques atraumatiques  
Pinzas hemostáticas atraumáticas  
Pinze emostatiche atraumatiche

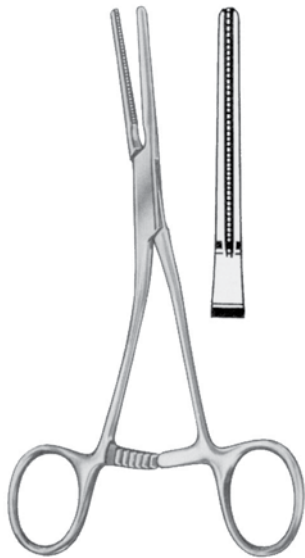

DE BAKEY  
15.0 cm **GD10.303.15**



DE BAKEY  
17.0 cm **GD10.307.17**



DE BAKEY

**GD10.309.17**  
17.0 cm

**GD10.309.16**  
16.0 cm





Atraumatic Hemostatic Forceps  
Atraumatische Gefäßklemmen  
Pinces hémostatiques atraumatiques  
Pinzas hemostáticas atraumáticas  
Pinze emostatiche atraumatiche



Atraumatic Multi-Purpose Clamps  
Atraumatische Mehrzweckklemmen  
Pinces-clamps polyvalentes  
Pinzas clamps para usos varios  
Pinze atraumatiche per diversi usi



DE BAKEY

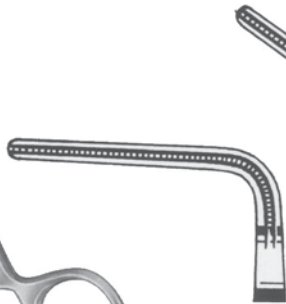

GD10.311.14  
14.0 cm

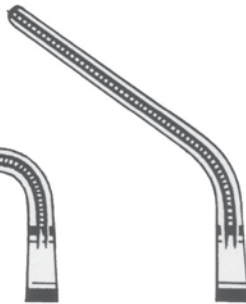

GD10.311.15  
15.0 cm



GD10.311.16  
16.0 cm

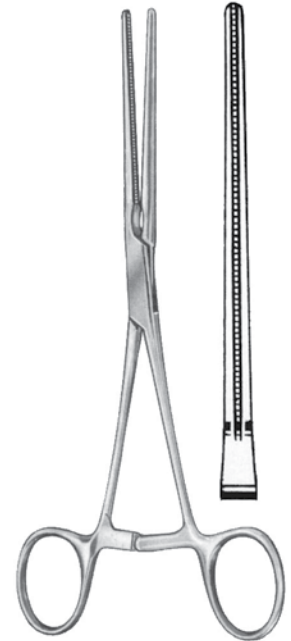

GLOVER

17.0 cm GD10.321.17

Anastomosis Clamps  
Anastomosenklemmen  
Pinces à anastomose  
Pinzas para anastomosis  
Pinze per anastomosi



DE BAKEY REYNOLDS



GD10.329.01  
17.5 cm  
Fig. 1



GD10.329.02  
17.5 cm  
Fig. 2

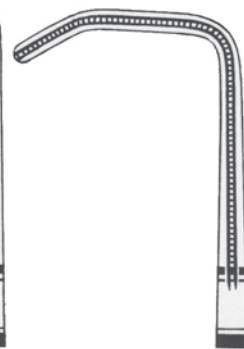

GD10.329.03  
16.5 cm  
Fig. 3

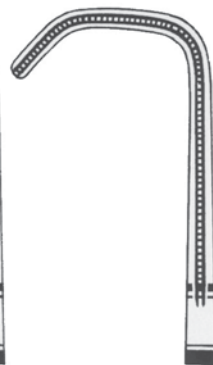

GD10.329.04  
16.5 cm  
Fig. 4

Atraumatic Hemostatic Forceps  
 Atraumatische Gefäßklemmen  
 Pinces hémostatiques atraumatiques  
 Pinzas hemostáticas atraumáticas  
 Pinze emostatiche atraumatiche

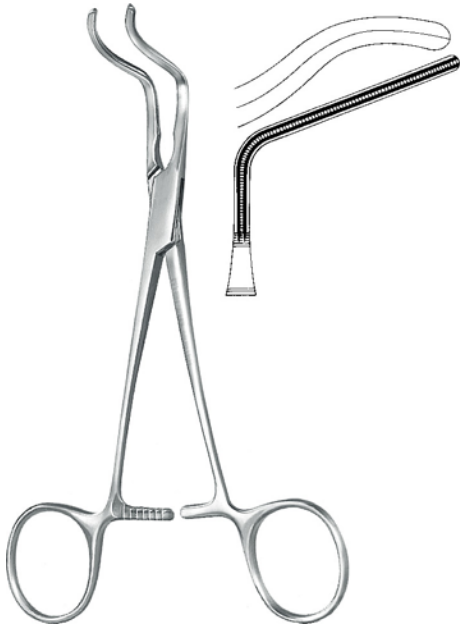

**SUBRAMANIAN**  
 15.0 cm **GD10.331.15**



**SUBRAMANIAN**  
 16.0 cm **GD10.333.16**

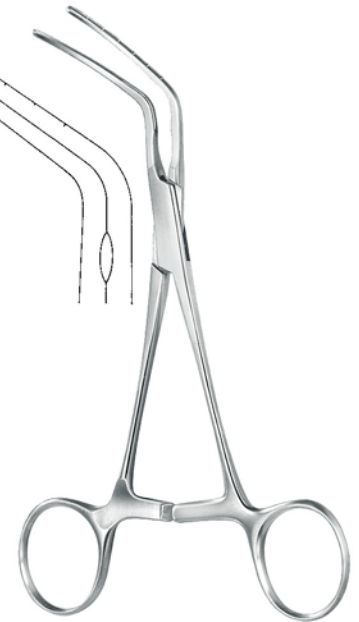

**SUBRAMANIAN**  
 16.0 cm **GD10.335.16**

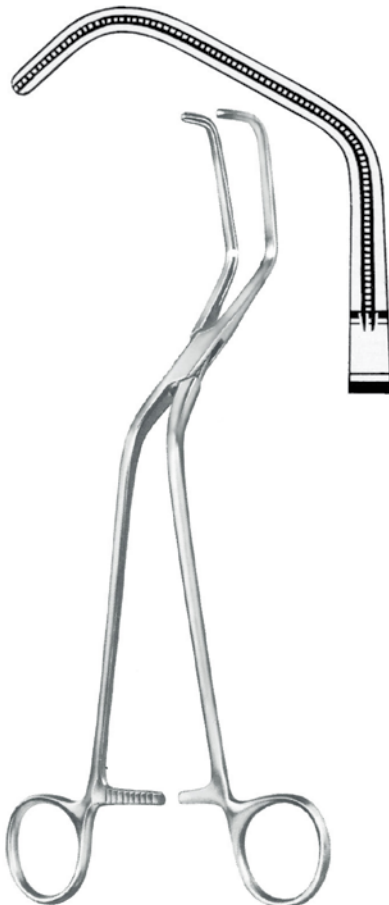

**OCHSNER**  
 23.0 cm **GD10.337.23**

Aortic Clamp  
 Aortaklemmen  
 Pince-clamp à aorte  
 Pinza clamp para aorta  
 Pinza per aorta



**DIETRICH**  
 21.0 cm **GD10.339.21**



**Atraumatic Hemostatic Forceps**  
**Atraumatische Gefäßklemmen**  
**Pinces hémostatiques atraumatiques**  
**Pinzas hemostáticas atraumáticas**  
**Pinze emostatiche atraumatiche**

**GRAND**  
 DEVICES  
*The Grand Instruments Company*

Dissecting and Ligature Clamps  
 Präparier- und Ligaturklemmen  
 Pinces à dissection et passe-fil  
 Pinzas de disección y para ligaduras  
 Pinze per dissezione e per legature



**DE BAKEY**

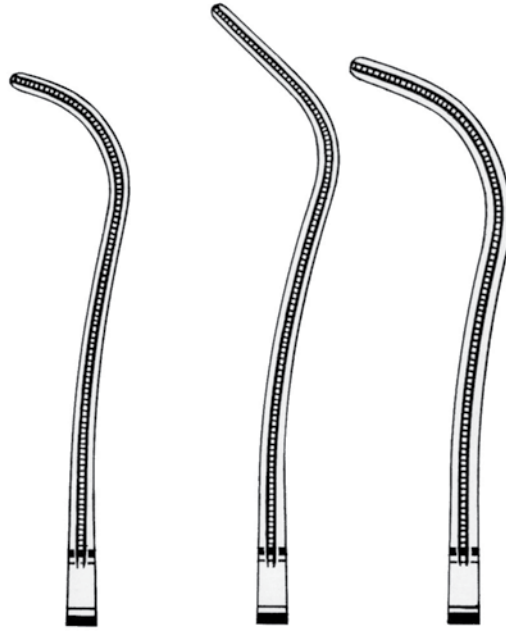

**GD10.341.19**  
19.0 cm

**GD10.341.20**  
20.0 cm

**GD10.341.23**  
23.0 cm

Carotid Shunt Clamps  
 Carotis-Shuntklemmen  
 Pinces pour carotide  
 Pinzas para shunt carótido  
 Pinze carotis

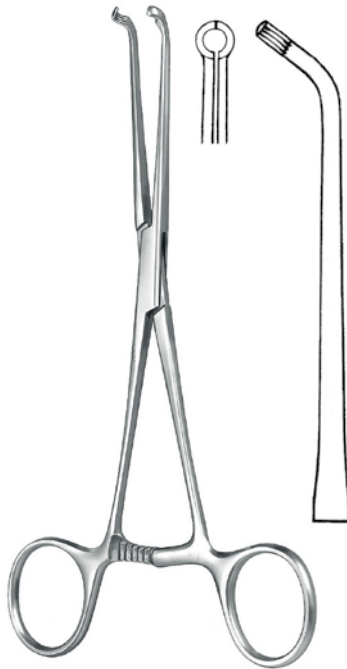

**JAVID**

18.0 cm **GD10.343.18**



**JAVID**

19.0 cm **GD10.343.19**

Atraumatic Hemostatic Forceps  
 Atraumatische Gefäßklemmen  
 Pinces hémostatiques atraumatiques  
 Pinzas hemostáticas atraumáticas  
 Pinze emostatiche atraumatiche



Profunda Clamps  
 Profunda-Klemmen  
 Pinces-clamps pour profunda  
 Pinzas clamps para profunda  
 Pinze per profunda



GREGORY



GD10.349.14  
14.0 cm



GD10.349.16  
16.0 cm

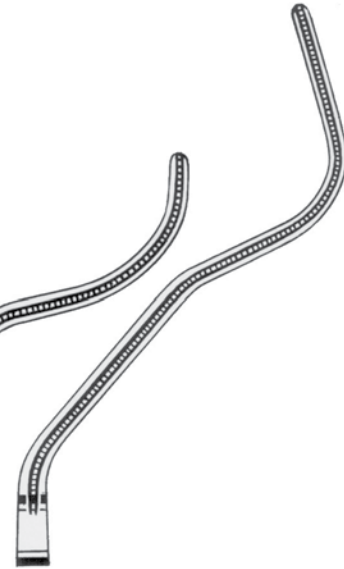

GD10.349.18  
18.0 cm

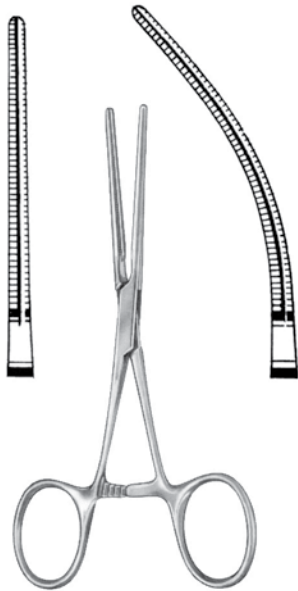

COOLEY

GD10.350.13 13.0 cm GD10.351.13

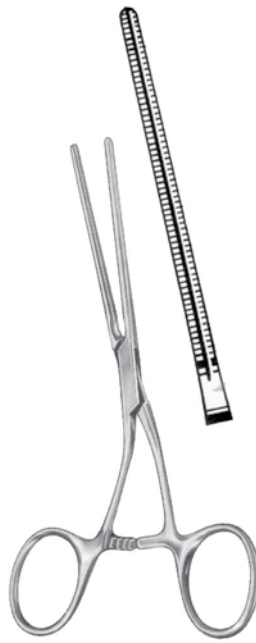

COOLEY

13.5 cm GD10.353.13



COOLEY

13.0 cm GD10.355.13



Atraumatic Hemostatic Forceps  
Atraumatische Gefäßklemmen  
Pinces hémostatiques atraumatiques  
Pinzas hemostáticas atraumáticas  
Pinze emostatiche atraumatiche

**GRAND**  
DEVICES  
*The Grand Instruments Company*



COOLEY  
12.5 cm **GD10.357.12**



COOLEY  
10.5 cm **GD10.359.10**

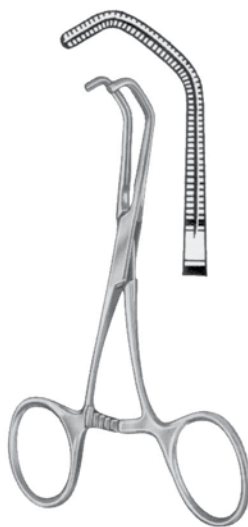

COOLEY  
12.0 cm **GD10.361.12**



COOLEY  
13.5 cm **GD10.363.13**

Atraumatic Hemostatic Forceps  
 Atraumatische Gefäßklemmen  
 Pinces hémostatiques atraumatiques  
 Pinzas hemostáticas atraumáticas  
 Pinze emostatiche atraumatiche

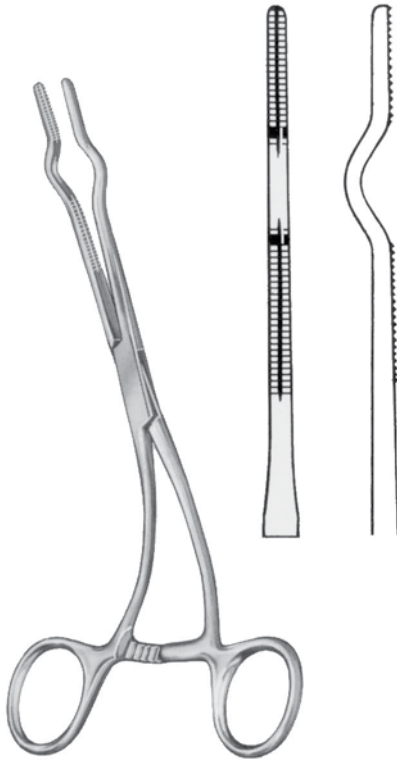

Fr./Charrière COOLEY

- 24      **GD10.371.24**
- 26      **GD10.371.26**
- 28      **GD10.371.28**
- 30      **GD10.371.30**
- 32      **GD10.371.32**
- 36      **GD10.371.36**



COOLEY

- GD10.376.14** 14.0 cm      **GD10.377.14**
- GD10.376.16** 16.0 cm      **GD10.377.16**

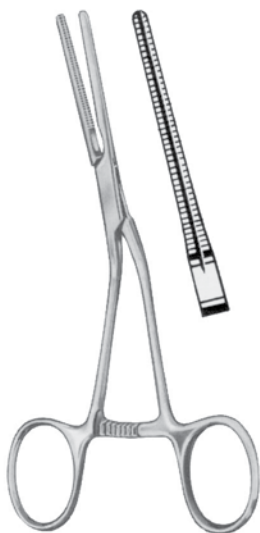

COOLEY

- 14.0 cm      **GD10.379.14**



COOLEY

- 14.0 cm      **GD10.380.14**



COOLEY

- 14.0 cm      **GD10.381.14**



Atraumatic Hemostatic Forceps  
Atraumatische Gefäßklemmen  
Pinces hémostatiques atraumatiques  
Pinzas hemostáticas atraumáticas  
Pinze emostatiche atraumatiche

**GRAND**<sup>®</sup>  
DEVICES  
*The Grand Instruments Company*

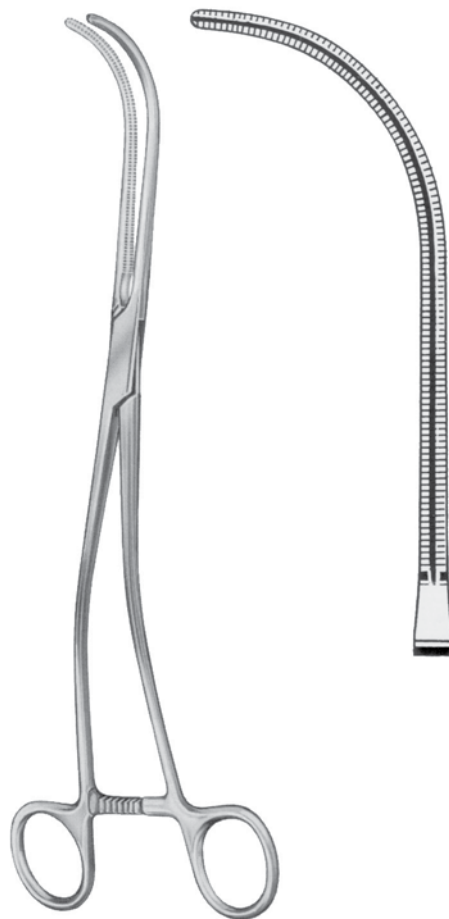

COOLEY

27.0 cm **GD10.405.27**

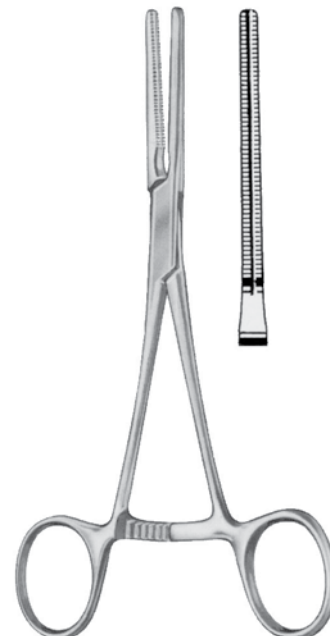

COOLEY

17.0 cm **GD10.410.17**

Atraumatic Hemostatic Forceps  
 Atraumatische Gefäßklemmen  
 Pincés hémostatiques atraumatiques  
 Pinzas hemostáticas atraumáticas  
 Pinze emostatiche atraumatiche



Atraumatic Multi-Purpose Clamps  
 Atraumatische Mehrzweckklemmen  
 Pincés-clamps polyvalentes  
 Pinzas clamps para usos varios  
 Pinze atraumatiche per diversi usi



COOLEY



GD10.411.17  
17.0 cm



GD10.413.17  
17.0 cm



GD10.416.17  
17.0 cm

Iliac Clamps  
 Iliaca-Klemmen  
 Pincés-clamps à iliaque  
 Pinzas clamps para iliaca  
 Pinze per iliaca



COOLEY

21.5 cm GD10.417.21

Anastomosis Clamps  
 Anastomosenklemmen  
 Pincés à anastomose  
 Pinzas para anastomosis  
 Pinze per anastomosi



COOLEY

17.0 cm GD10.419.17

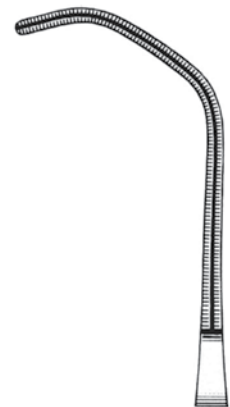





Atraumatic Hemostatic Forceps  
Atraumatische Gefäßklemmen  
Pinces hémostatiques atraumatiques  
Pinzas hemostáticas atraumáticas  
Pinze emostatiche atraumatiche

**GRAND**<sup>®</sup>  
DEVICES  
*The Grand Instruments Company*

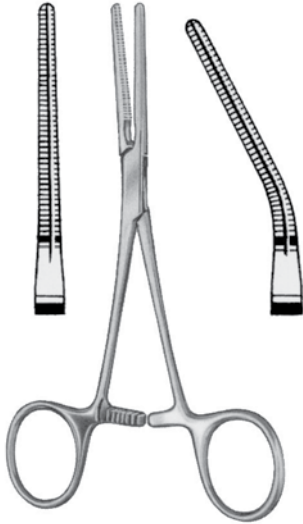

COOLEY

GD10.420.14 14.0 cm GD10.421.14



COOLEY

14.0 cm GD10.423.14

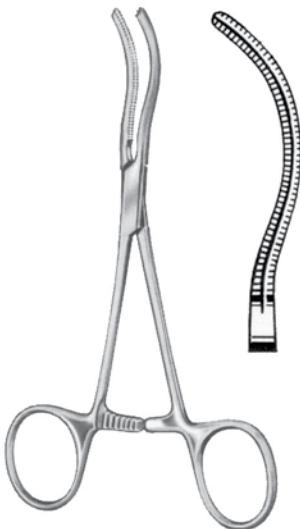

COOLEY

14.0 cm GD10.425.14



COOLEY



GD10.427.16  
16.0 cm

GD10.427.15  
15.0 cm

Atraumatic Hemostatic Forceps  
 Atraumatische Gefäßklemmen  
 Pincès hémostatiques atraumatiques  
 Pinzas hemostáticas atraumáticas  
 Pinze emostatiche atraumatiche



Atraumatic Multi-Purpose Clamps  
 Atraumatische Mehrzweckklemmen  
 Pincès-clamps polyvalentes  
 Pinzas clamps para usos varios  
 Pinze atraumatiche per diversi usi

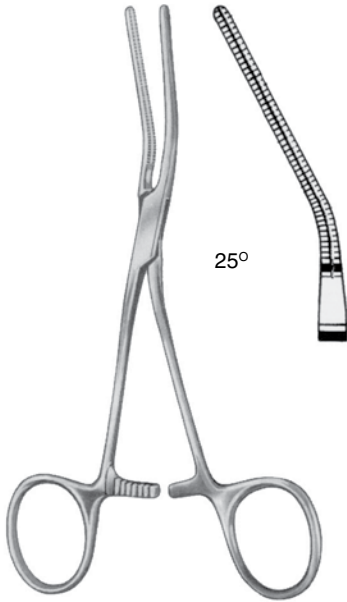

25°

COOLEY

16.5 cm **GD10.431.25**

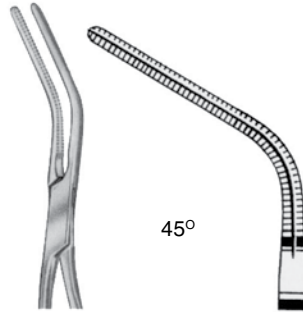

45°

COOLEY

16.5 cm **GD10.431.45**

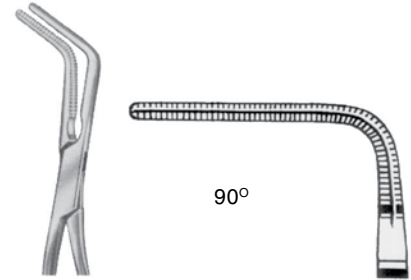

90°

COOLEY

16.5 cm **GD10.431.90**

Anastomosis Clamps  
 Anastomosenklemmen  
 Pincès à anastomose  
 Pinzas para anastomosis  
 Pinze per anastomosi



COOLEY

14.0 cm **GD10.433.14**



COOLEY DERRA

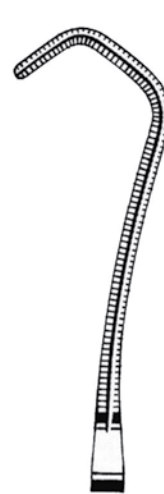

**GD10.441.16**  
16.0 cm



**GD10.441.17**  
17.0 cm

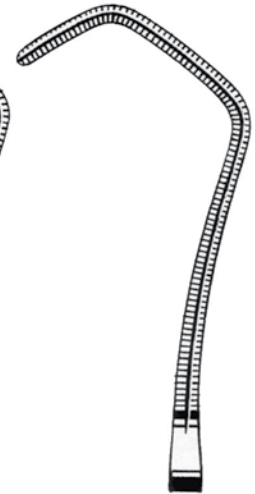

**GD10.441.18**  
18.0 cm



Atraumatic Hemostatic Forceps  
Atraumatische Gefäßklemmen  
Pincés hémostatiques atraumatiques  
Pinzas hemostáticas atraumáticas  
Pinze emostatiche atraumatiche

**GRAND**  
DEVICES  
The Grand Instruments Company

Anastomosis Clamps  
Anastomosenklemmen  
Pincés à anastomose  
Pinzas para anastomosis  
Pinze per anastomosi



**COOLEY**  
17.0 cm

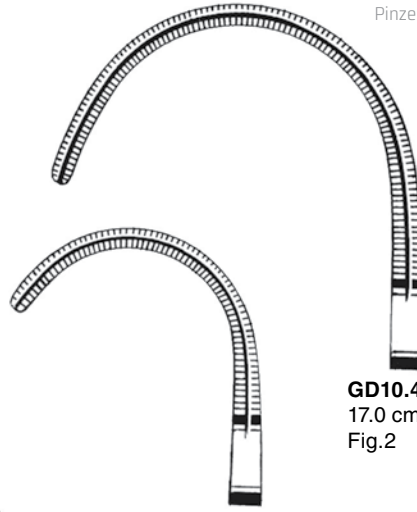

**GD10.447.17**  
17.0 cm  
Fig.1

**GD10.44910.17**  
17.0 cm  
Fig.2

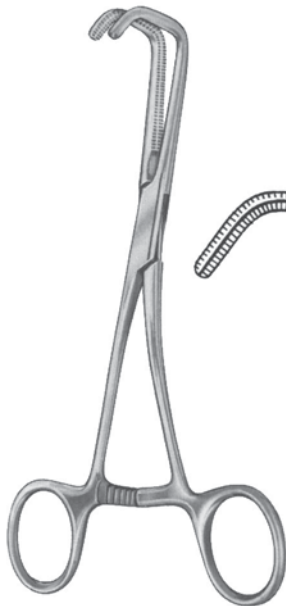

**COOLEY**

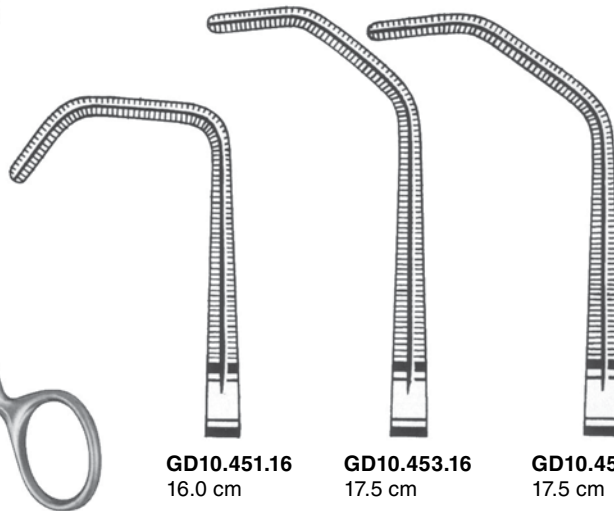

**GD10.451.16**  
16.0 cm

**GD10.453.16**  
17.5 cm

**GD10.455.17**  
17.5 cm

Atraumatic Hemostatic Forceps  
Atraumatische Gefäßklemmen  
Pinces hémostatiques atraumatiques  
Pinzas hemostáticas atraumáticas  
Pinze emostatiche atraumatiche

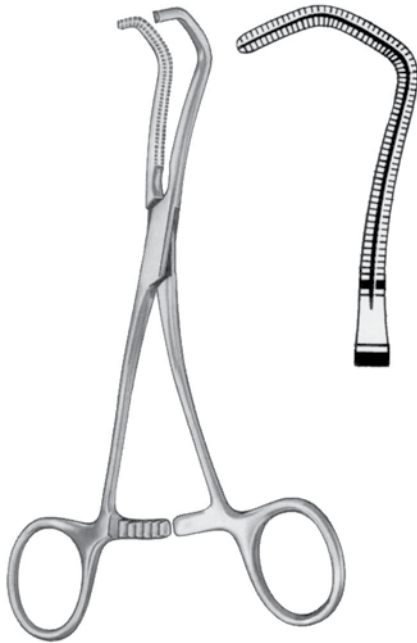

COOLEY

17.0 cm GD10.457.17

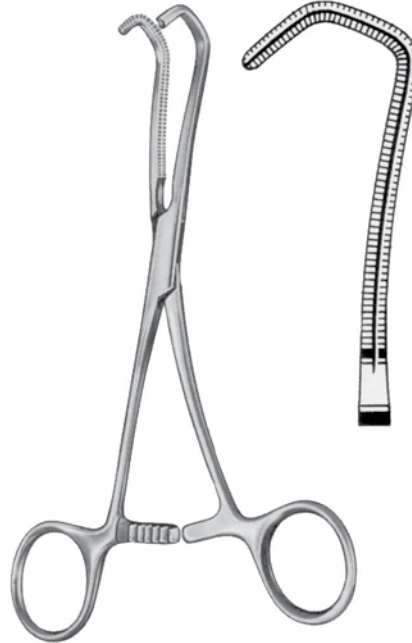

COOLEY

17.0 cm GD10.461.17



COOLEY

18.0 cm GD10.465.18



COOLEY

19.0 cm GD10.465.19



COOLEY

26.0 cm GD10.465.26

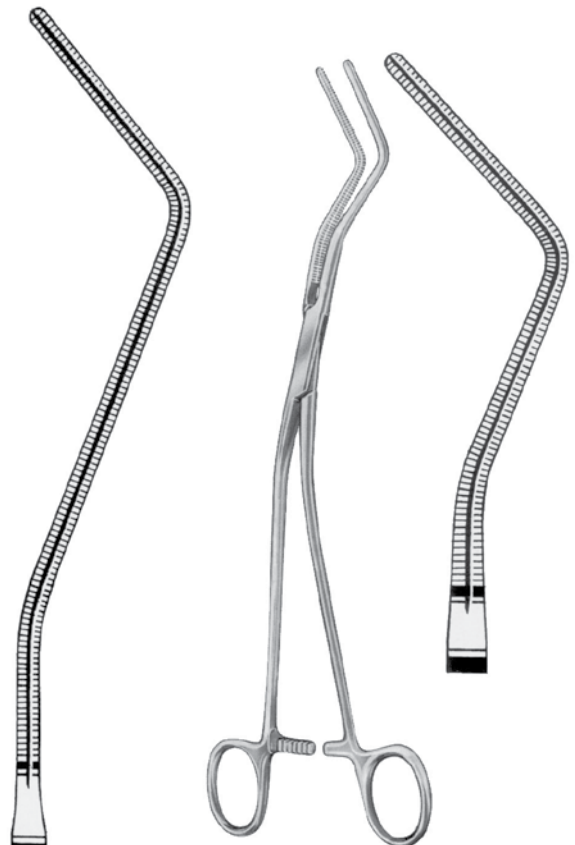

COOLEY

27.0 cm GD10.467.27



**Atraumatic Hemostatic Forceps**  
**Atraumatische Gefäßklemmen**  
**Pinces hémostatiques atraumatiques**  
**Pinzas hemostáticas atraumáticas**  
**Pinze emostatiche atraumatiche**

**GRAND**  
DEVICES  
*The Grand Instruments Company*

Neonatal and Childrens Clamps, extra delicate patterns  
Neonatal- und Kinderklemmen, extra feine Modelle  
Pinces-clamps pour des nouveaux-nés et des enfants, modèles très fins  
Pinzas clamps para recién nacidos y niños, modelos muy finos  
Pinze pediatriche, modelli molto fini



**CASTANEDA**  
13.0 cm **GD10.481.13**



**CASTANEDA**  
13.0 cm

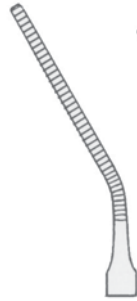

**GD10.483.13**  
13.0 cm  
Fig. 1



**GD10.485.13**  
13.0 cm  
Fig. 2

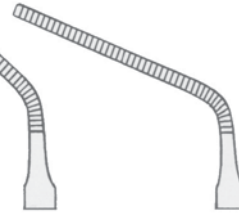

**GD10.487.13**  
13.0 cm  
Fig. 3



**GD10.489.13**  
13.0 cm  
Fig. 4



**CASTANEDA**  
12.0 cm

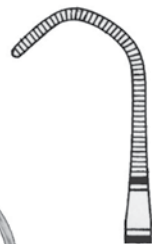

**GD10.491.15**  
12.0 cm  
Fig. 1

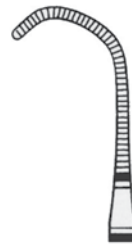

**GD10.493.15**  
12.0 cm  
Fig. 2



**GD10.495.12**  
12.0 cm  
Fig. 3

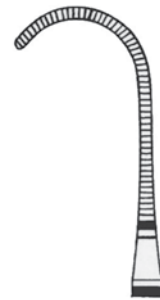

**GD10.495.15**  
12.0 cm  
Fig. 4

Atraumatic Hemostatic Forceps  
 Atraumatische Gefäßklemmen  
 Pincés hémostatiques atraumatiques  
 Pinzas hemostáticas atraumáticas  
 Pinze emostatiche atraumatiche



Pediatric Vascular Clamp  
 Kinder-Gefäßklemmen  
 Pincés vasculaires pédiatriques  
 Pinzas vasculares pediátricas  
 Pinze vascolari pediatriche



straight  
 gerade  
 droites  
 rectas  
 rette

**GD10.502.01 GD10.502.09**  
 Fig. 1 - 9



angled  
 abgewinkelt  
 coudées  
 acodadas  
 angolari

**GD10.503.01 GD10.503.09**  
 Fig. 1 - 9



strongly angled  
 stark abgewinkelt  
 fortement coudées  
 fuertemente acodadas  
 fortemente angolari

**GD10.505.01 GD10.505.09**  
 Fig. 1 - 9

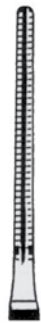

Fig. 1  
**GD10.502.01**  
**GD10.503.01**  
**GD10.505.01**

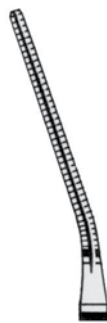

Fig. 2  
**GD10.502.02**  
**GD10.503.02**  
**GD10.505.02**

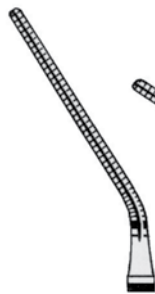

Fig. 3  
**GD10.502.03**  
**GD10.503.03**  
**GD10.505.03**

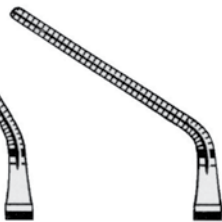

Fig. 4  
**GD10.502.04**  
**GD10.503.04**  
**GD10.505.04**



Fig. 5  
**GD10.502.05**  
**GD10.503.05**  
**GD10.505.05**



Fig. 6  
**GD10.502.06**  
**GD10.503.06**  
**GD10.505.06**

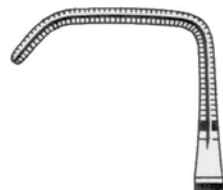

Fig. 7  
**GD10.502.07**  
**GD10.503.07**  
**GD10.505.07**

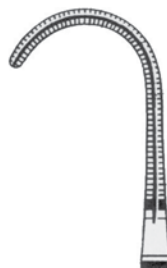

Fig. 8  
**GD10.502.08**  
**GD10.503.08**  
**GD10.505.08**

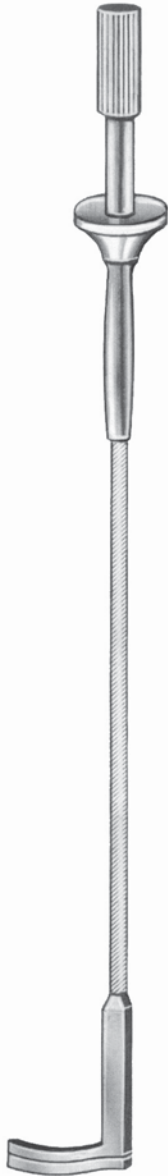

Fig. 9  
**GD10.502.09**  
**GD10.503.09**  
**GD10.505.09**



Flexible Vessel Clamps  
Flexible Gefäßklemmen  
Pinces vasculaires flexibles  
Pinzas vasculares flexibles  
Pinze vascolari flessibili

**GRAND**  
DEVICES  
*The Grand Instruments Company*



**GD10.609.12**  
12.0 mm



**GD10.609.20**  
20.0 mm



**GD10.609.30**  
30.0 mm

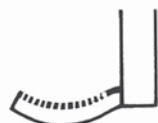

**GD10.611.12**  
12.0 mm



**GD10.611.20**  
20.0 mm



**GD10.611.30**  
30.0 mm

**GD10.609.12 GD10.611.30**  
20.0 cm

Flexible Vessel Clamps  
Flexible Gefäßklemmen  
Pinces vasculaires flexibles  
Pinzas vasculares flexibles  
Pinze vascolari flessibili

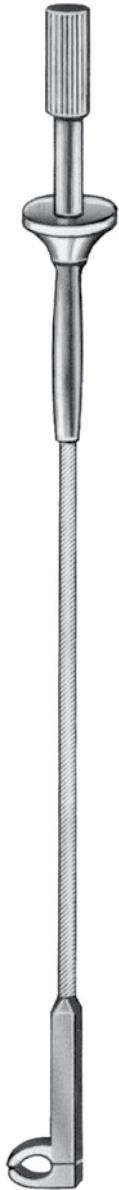

**GD10.615.03**  
ø 3 mm



**GD10.615.05**  
ø 5 mm



**GD10.615.07**  
ø 7 mm



**GD10.615.09**  
ø 9 mm

GD10.615.03 GD10.615.09





Scalpels, Knives  
Skalpelle, Messer  
Bistouris, Couteaux  
Bisturías, Cuchillos  
Bisturi, Coltelli  
手术刀和刀



**GD11**



Scalpel Handles  
 Skalpellgriffe  
 Manches de bistouris  
 Mangos de bisturíes  
 Manici per bisturi



Scalpel Handles for scalpel blades fig. 10, 11, 12, 13, 15

Skalpellgriffe, passend für auswechselbare Skalpellklingen Fig. 10, 11, 12, 13, 15

Manches pour bistouris, allant avec les lames de bistouris interchangeables fig. 10, 11, 12, 13, 15

Mangos de bisturí para hojas intercambiables fig. 10, 11, 12, 13, 15

Manici per bisturi, per fissare le lame intercambiabili fig. 10, 11, 12, 13, 15

Fig. 3



**GD11.103.00**  
 Fig. 3  
 12.0 cm

handle style as fig. 4  
 Heftprofil wie Griff Fig. 4  
 manche selon fig. 4  
 mango como fig. 4  
 manico come fig. 4



**GD11.103.10**  
 Fig. 3  
 12.0 cm

cm-graduation  
 mit Zentimeter-Graduierung  
 gradué en cm  
 graduado en cm  
 graduato in cm



**GD11.103.01**  
 Fig. 3  
 12.0 cm

long  
 lang  
 long  
 largo  
 lungo



**GD11.103.02**  
 Fig. 3L  
 21.5 cm

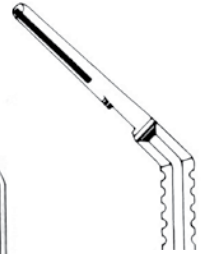

angled, long  
 abgewinkelt, lang  
 coudé, long  
 angulado, largo  
 angolare, lungo



**GD11.103.06**  
 Fig. 3L  
 21.0 cm



Scalpel Handles for scalpel blades fig. 10, 11, 12, 13, 15

Skalpgriffe, passend für auswechselbare Skalpgriffklingen Fig. 10, 11, 12, 13, 15

Manches pour bistouris, allant avec les lames de bistouris interchangeables fig. 10, 11, 12, 13, 15

Mangos de bisturí para hojas intercambiables fig. 10, 11, 12, 13, 15

Manici per bisturi, per fissare le lame intercambiabili fig. 10, 11, 12, 13, 15

Fig.  
3

round  
 rund  
 rond  
 redondo  
 rotondo

round, angled  
 rund, abgewinkelt  
 rond, coudé  
 redondo, angulado  
 rotondo, angolare

round  
 rund  
 rond  
 redondo  
 rotondo



**GD11.103.03**  
 Fig. 3  
 14.5 cm



**GD11.103.33**  
 Fig. 3  
 14.0 cm



**GD11.103.15**  
 Fig. 3  
 15.0 cm



**Scalpel Handles**  
**Skalpellgriffe**  
**Manches de bistouris**  
**Mangos de bisturíes**  
**Manici per bisturi**

**GRAND**  
 DEVICES  
*The Grand Instruments Company*

Scalpel Handles for scalpel blades fig. 10, 11, 12, 13, 15

Skalpellgriffe, passend für auswechselbare Skalpellklingen Fig. 10, 11, 12, 13, 15

Manches pour bistouris, allant avec les lames de bistouris interchangeables fig. 10, 11, 12, 13, 15

Mangos de bisturí para hojas intercambiables fig. 10, 11, 12, 13, 15

Manici per bisturi, per fissare le lame intercambiabili fig. 10, 11, 12, 13, 15

with round hollow handle  
 mit rundem Hohlheft  
 avec manche creux rond  
 con mango hueco redondo  
 con manico vuoto, rotondo

with plastic handle  
 mit Kunststoffheft  
 avec manche en matière plastique  
 con mango plástico  
 con manico di materia plastica

**Fig. 3**

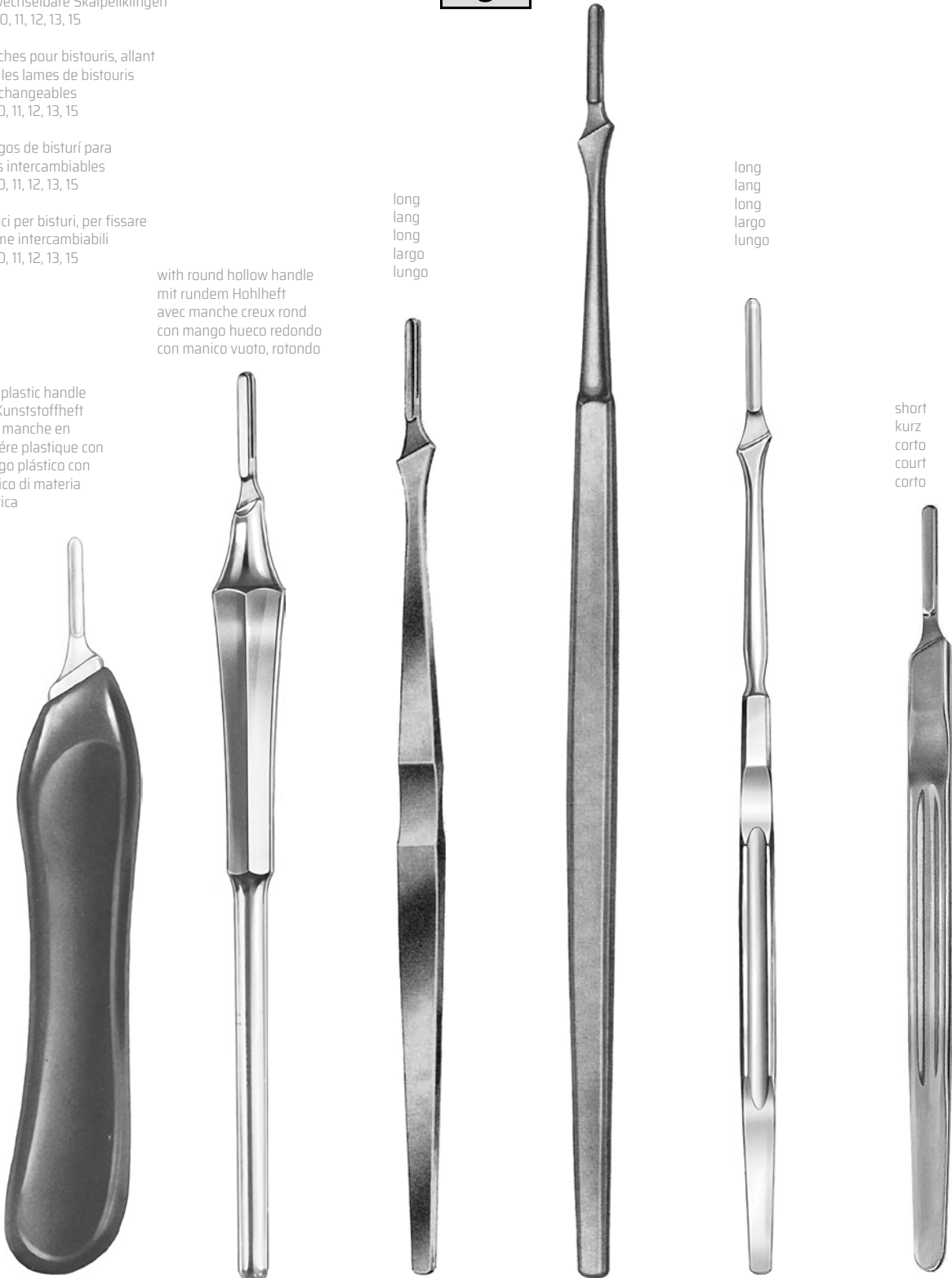

long  
 lang  
 long  
 long  
 largo  
 lungo

long  
 lang  
 long  
 largo  
 lungo

short  
 kurz  
 corto  
 court  
 corto

**GD11.103.08**  
 Fig. 3  
 12.5 cm

**GD11.103.09**  
 Fig. 3  
 15.5 cm

**GD11.105.00**  
 Fig. 5  
 16.0 cm

**GD11.106.00**  
 Fig. 5  
 21.5 cm

**GD11.107.00**  
 Fig. 7  
 16.0 cm

**GD11.107.01**  
 Fig. 7K  
 12.5 cm



Scalpel Handles for scalpel blades fig. 10, 11, 12, 13, 15

Skalpellgriffe, passend für auswechselbare Skalpellklingen Fig. 10, 11, 12, 13, 15

Manches pour bistouris, allant avec les lames de bistouris interchangeables fig. 10, 11, 12, 13, 15

Mangos de bisturí para hojas intercambiables fig. 10, 11, 12, 13, 15

Manici per bisturi, per fissare le lame intercambiabili fig. 10, 11, 12, 13, 15

Fig.  
3



**GD11.109.00**  
21.0 cm



**GD11.109.16**  
Fig. 3 + 4  
16.0 cm

Scalpel Handle for scalpel blades fig. 10 - 36

Skalpellgriff, passend für auswechselbare Skalpellklingen Fig. 10 - 36

Manche pour bistouri, allant avec les lames de bistouris interchangeables fig. 10 - 36

Mango de bisturí para hojas intercambiables fig. 10 - 36

Manico per bisturi, per fissare le lame intercambiabili fig. 10 - 36

double handle fig. 3 + 4  
Doppelgriff Fig. 3 + 4  
manche double fig. 3 + 4  
mango doble fig. 3 + 4  
manico doppio fig. 3 + 4



Scalpel Blades, sterile  
Skalpellklingen, steril  
Lames des bistouris, stériles  
Hojas de bisturios estériles  
Lame da bisturi, sterili

**GRAND**  
DEVICES  
*The Grand Instruments Company*

Fig.  
3



GD11.110.00



GD11.111.00



GD11.112.00



GD11.112.02



GD11.115.00



GD11.115.01



in packages of 100 ea  
In Packungen à 100  
en boîtes de 100 pieces  
en cajas de 100 c/u  
in scatole di 100 pezzi



**GD11.199.00**  
Scalpel Blade Remover  
Skalpellklingen-Entferner  
Enlève-lame  
Quita hojas  
Distributore lame



**Fig.  
4**

Scalpel Handles for scalpel blades fig. 18, 19, 20, 21, 22, 23, 24, 25, 36

Skalpellgriffe, passend für auswechselbare Skalpellschneiden Fig. 18, 19, 20, 21, 22, 23, 24, 25, 36

Manches pour bistouris, allant avec les lames de bistouris interchangeables fig. 18, 19, 20, 21, 22, 23, 24, 25, 36

Mangos de bisturí para hojas intercambiables fig. 18, 19, 20, 21, 22, 23, 24, 25, 36

Manici per bisturi, per fissare le lame intercambiabili fig. 18, 19, 20, 21, 22, 23, 24, 25, 36

long  
lang  
long  
largo  
lungo

angled, long  
abgewinkelt, lang  
coudé, long  
angulado, largo  
angolaro, lungo

cm-graduation  
mit Zentimeter-Graduierung  
gradué en cm  
graduado en cm  
graduato in cm

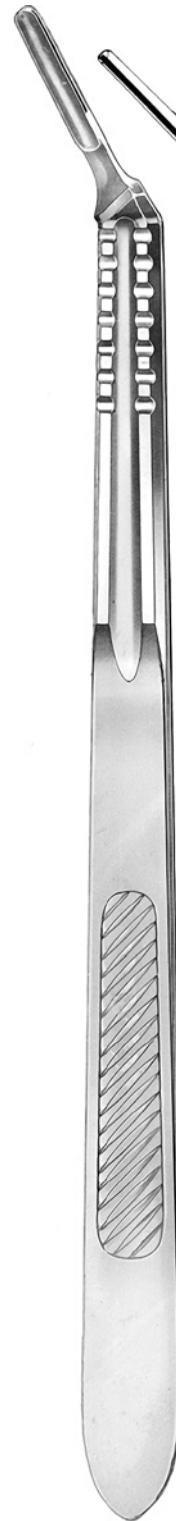

**GD11.104.00**  
Fig. 4  
13.0 cm

**GD11.104.01**  
Fig. 4  
13.0 cm

**GD11.104.03**  
--  
21.5 cm

**GD11.104.02**  
Fig. 4L  
21.00cm

**GD11.104.06**  
Fig. 4L  
21.00cm





Scalpel Handles  
Skalpellgriffe  
Manches de bistouris  
Mangos de bisturíes  
Manici per bisturi

**GRAND**<sup>®</sup>  
DEVICES  
The Grand Instruments Company

Scalpel Handles for scalpel blades fig. 18, 19, 20, 21, 22, 23, 24, 25, 36

Skalpellgriffe, passend für auswechselbare Skalpellschlingen Fig. 18, 19, 20, 21, 22, 23, 24, 25, 36

Manches pour bistouris, allant avec les lames de bistouris interchangeables fig. 18, 19, 20, 21, 22, 23, 24, 25, 36

Mangos de bisturí para hojas intercambiables fig. 18, 19, 20, 21, 22, 23, 24, 25, 36

Manici per bisturi, per fissare le lame intercambiabili fig. 18, 19, 20, 21, 22, 23, 24, 25, 36

with plastic handle  
mit Kunststoffheft  
avec manche en matière plastique  
con mango plástico  
con manico di materia plastica



**GD11.104.08**  
Fig. 4  
13.5 cm

Fig.  
4

with hollow handle  
mit Hohlheft  
avec manche creux  
con mango hueco  
con manico vuoto



**collin**  
**GD11.108.00**  
Fig. 8  
13.5 cm

with hollow handle  
mit Hohlheft  
avec manche creux  
con mango hueco  
con manico vuoto



**collin**  
**GD11.108.09**  
Fig. 9  
14.5 cm

Scalpel Blades, sterile  
 Skalpellklingen, steril  
 Lames des bistouris,  
 stériles  
 Hojas de bisturíes  
 estériles  
 Lame da bisturi, sterili



Fig.  
4

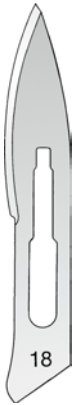

GD11.118.00



GD11.119.00



GD11.120.00



GD11.121.00



GD11.122.00



GD11.123.00



GD11.124.00



GD11.125.00



GD11.126.00



in packages of 100 ea  
 In Packungen à 100  
 en boîtes de 100 pieces  
 en cajas de 100 c/u  
 in scatole di 100 pezzi



**GD11.199.00**  
 Scalpel Blade Remover  
 Skalpellklingen-Entferner  
 Enlève-lame  
 Quita hojas  
 Distributore lame



Disposable Scalpels, sterile  
Einmalskalpelle, steril  
Bistouris usage unique, stériles  
Bisturías uso único, estériles  
Bisturi monouso, sterili

**GRAND**  
DEVICES  
*The Grand Instruments Company*



**GD11.210.00**  
Fig. 10

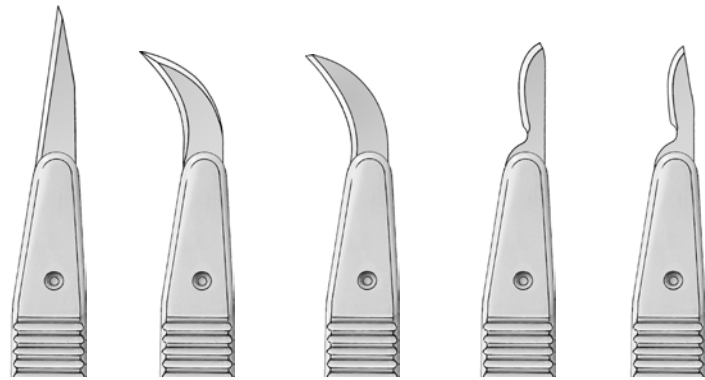

**GD11.211.00** **GD11.212.00** **GD11.212.02** **GD11.215.00** **GD11.215.01**  
Fig. 11 Fig. 12 Fig. 12 d Fig. 15 Fig. 15 c

in packages of 10 ea  
In Packungen à 10 Stück  
en boîtes de 10 pieces  
en cajas de 10 c/u  
in scatole di 10 pezzi

Disposable Scalpels, sterile  
Einmalskalpelle, steril  
Bistouris usage unique, stériles  
Bisturíes uso único, estériles  
Bisturi monouso, sterili

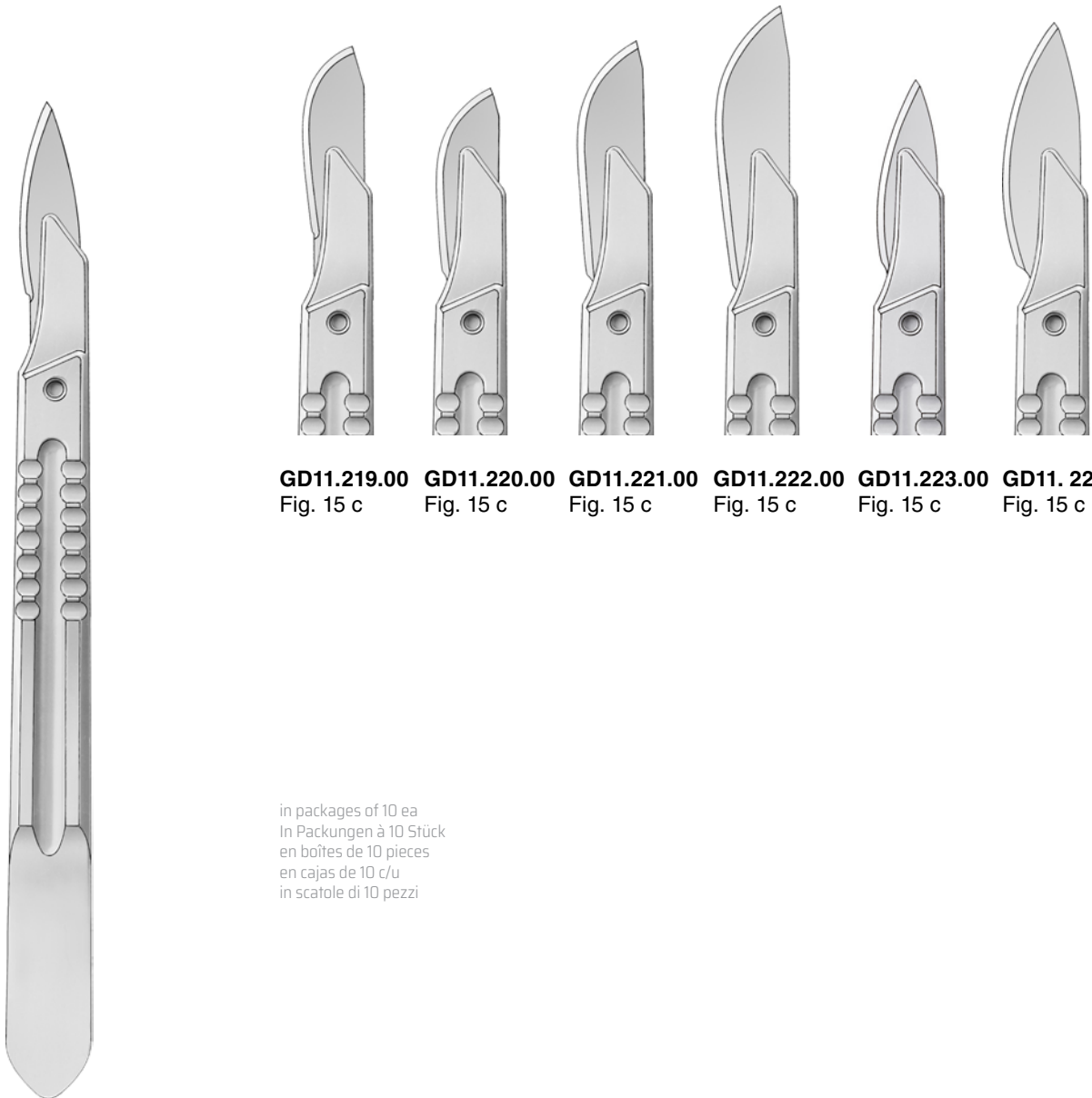

**GD11.219.00** **GD11.220.00** **GD11.221.00** **GD11.222.00** **GD11.223.00** **GD11.224.00**  
Fig. 15 c Fig. 15 c Fig. 15 c Fig. 15 c Fig. 15 c Fig. 15 c

in packages of 10 ea  
In Packungen à 10 Stück  
en boîtes de 10 pieces  
en cajas de 10 c/u  
in scatole di 10 pezzi

**GD11.218.00**  
Fig. 18



Scalpel Handles, Micro  
Skalpgriffe, Mikro  
Manches pour bistouris, Micro  
Mangos de bisturi, Micro  
Manici per bisturi, Micro

**GRAND**  
DEVICES  
*The Grand Instruments Company*

for micro scalpel blades  
für Mikro-Skalpellklingen  
pour micro-lame de bisturis  
para micro hojas  
per micro lame



**GD11.302.13**  
13.5 cm



**GD11.304.15**  
15.5 cm



**CASPAR**  
**GD11.306.18**  
18 cm



**GD11.308.20**  
20 cm

Scalpel Handles, Micro Scalpel Blades  
 Skalpellgriffe, Mikro-Skalpellklingen  
 Manches pour bistouris, Micro lame de bistouris  
 Mangos de bisturí, Micro hojas de bisturí Manici  
 per bisturi, Micro lame per bisturi



in packages of 10 ea, sterile  
 In Packungen à 10 Stück, steril  
 en boîtes de 10 pièces, stériles  
 en cajas de 10 c/u, estériles in  
 scatole di 10 pezzi, sterili

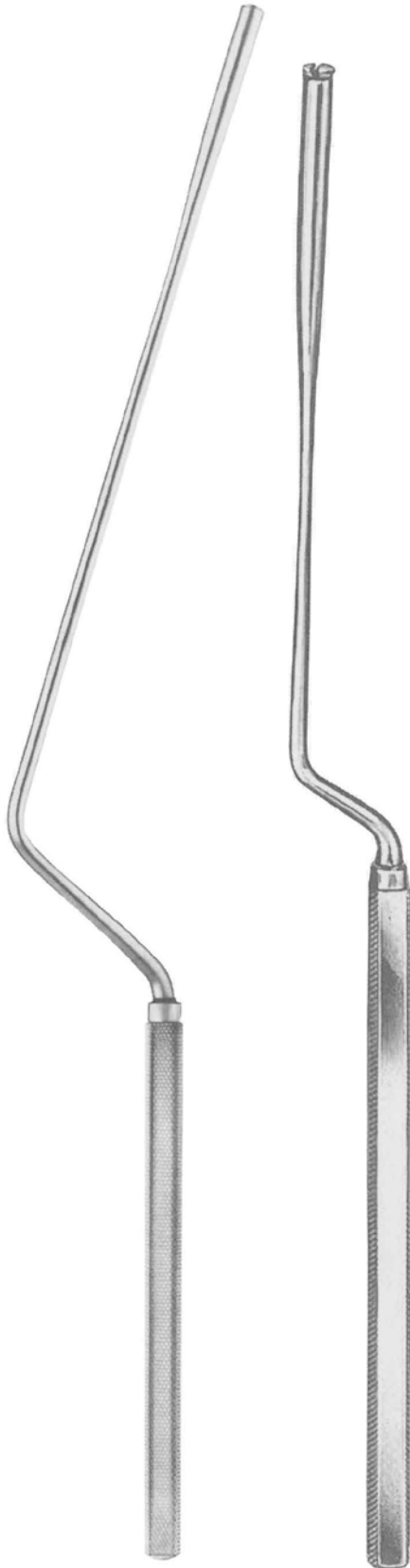

landolt  
**GD11.857.25**  
 25.0 cm

landolt  
**GD11.858.21**  
 21.0 cm



**GD11.859.01**  
 61#



**GD11.859.02**  
 62#



**GD11.859.04**  
 64#



**GD11.859.05**  
 65#



**GD11.859.07**  
 67#



**GD11.859.09**  
 69#



Blade Breakers, Razor Blades  
Klingenbrecher, Rasierklingen  
Casse-lames, rasoirs Rompehojas,  
hojas de afeitar Pinze  
rompe-lamette, lamette

**GRAND**  
DEVICES  
*The Grand Instruments Company*



**GD11.295.00**  
11.0 cm

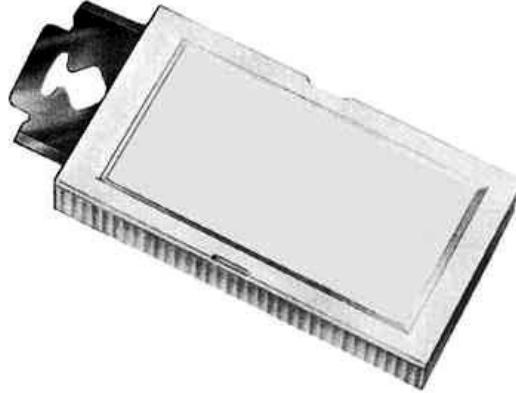

**GD11.296.00**  
Package = 10 ea  
Packung = 10  
Boîte = 10  
Cajita = 10 c/u  
Scatola = 10



**TROUTMAN-CHRIS**  
**GD11.290.09**  
9.0 cm



**DIMEDA**  
**GD11.291.11**  
11.0 cm

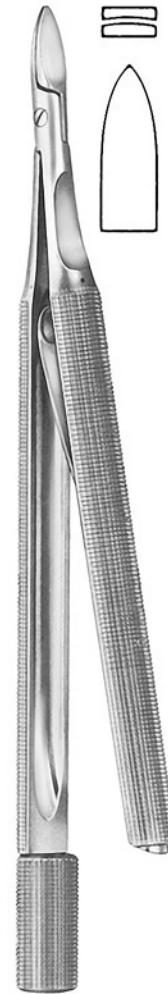

**CASTROVIEJO**  
**GD11.294.13**  
13.0 cm



**GD11.402.01** **GD11.402.02** **GD11.402.03** **GD11.402.04** **GD11.402.05**  
 Fig. 1 Fig. 2 Fig. 3 Fig. 4 Fig. 5  
 15.0 cm 15.0 cm 15.5 cm 16.0 cm 16.0 cm



**GD11.402.06** **GD11.402.07** **GD11.402.08** **GD11.402.09** **GD11.402.10**  
 Fig. 6 Fig. 7 Fig. 8 Fig. 9 Fig. 10  
 15.0 cm 15.0 cm 16.0 cm 16.0 cm 17.0 cm

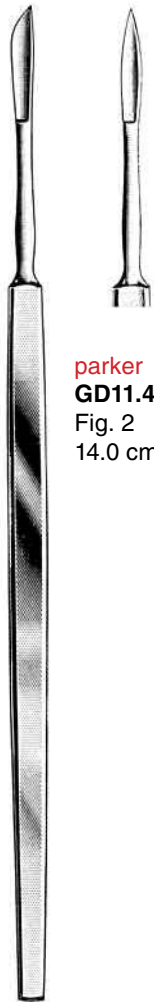

**parker**  
**GD11.408.02**  
 Fig. 2  
 14.0 cm

**parker**  
**GD11.408.01**  
 Fig. 1  
 14.0 cm





Amputating knives  
Amputationsmesser  
Couteaux à amputation  
Cuchillos para amputación  
Coltelli per amputazione

**GRAND**<sup>®</sup>  
DEVICES  
The Grand Instruments Company

With hollow handle  
mit Metallheft  
avec manche en métal  
con mango metálico  
con manico di metallo

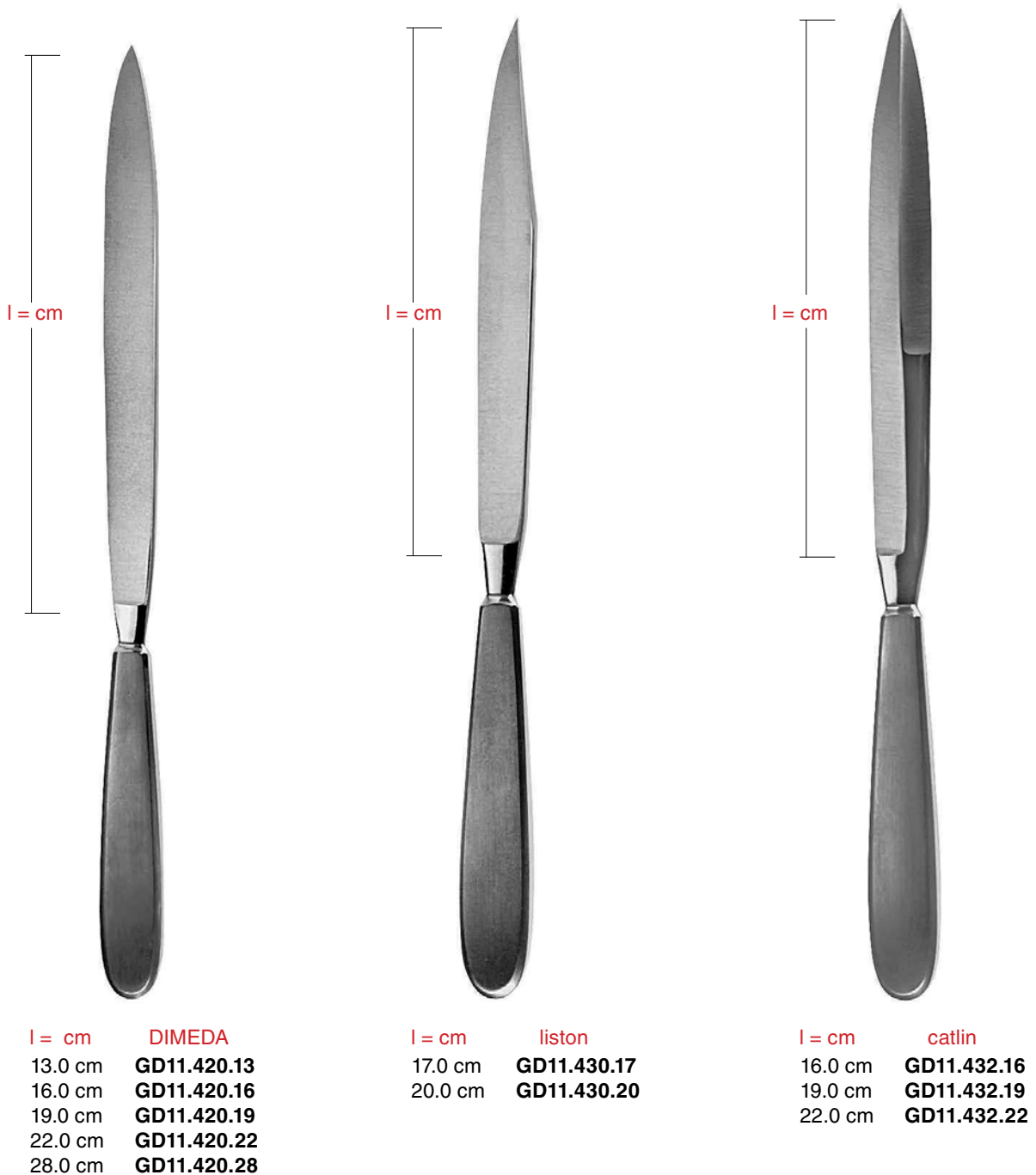

Resection knives  
Resektionsmesser  
Couteaux à résection  
Cuchillos p. resección  
Coltelli per resezione



L = Length of blade  
Klingenlänge  
longueur tranchant  
largo de corte  
lunghezza di taglio

solid handle, dissecting end  
massives Heft mit Schaber-Ende  
manche solide à rugine  
mango macizo, con periostótomo  
con manico pieno con raschino



langenbeck  
**GD11.410.05**  
18.0 cm



langenbeck  
**GD11.412.05**  
18.0 cm



langenbeck  
**GD11.414.05**  
18.0 cm



Cartilage, brain knife  
Knorpel-, Hirnmesser  
Couteaux à cartilage, à cerveau  
Cuchillo para cartilagos y p. cerebro  
Coltelli per cartilagini e per il cervello

**GRAND**  
DEVICES  
The Grand Instruments Company

with wooden handle  
mit Holzheft  
avec manche en bois  
con mango de madera  
con manico di legno

with raspatory  
mit Schaber  
avec râpe  
con periostótomo  
con raschiatoio

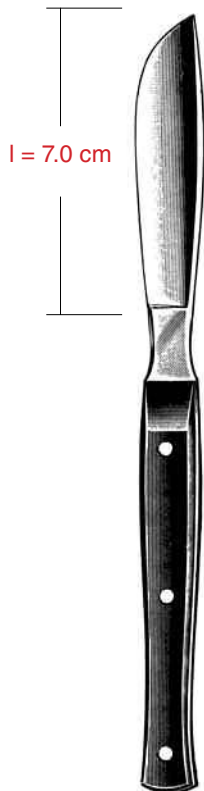

l = 7.0 cm

virchow  
GD11.960.25  
25.0 cm



l = 5.5 cm

GD11.970.55



l = 5.5 cm

GD11.971.55



l = 7.0 cm

GD11.972.70

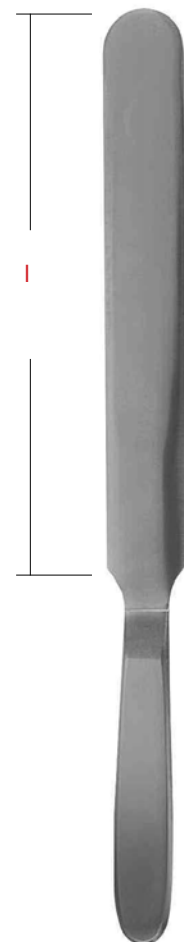

l = cm  
16.0 cm  
20.0 cm  
24.0 cm

virchow  
GD11.980.16  
GD11.980.20  
GD11.980.24



In packages of 10 ea, sterile  
In Packungen à 10 Stück, steril  
En boîtes de 10 pièces, stériles  
En cajas de 10 c/u, estériles in  
Scatole di 10 pezzi, sterili



GD11.494.00

GD11.494.01

Blade flat/hollow  
Klinge flach/hohl  
Lame à faces plane/ concave  
Hoja cóncava/convexa lama  
Piana/concava



GD11.496.00

Hollow blades on both sides  
Klinge beidseitig hohl  
Lame deux faces concaves  
Ambos lados cóncavos  
Lama concava/concava



GD11.497.00

Oil stone  
Abziehstein  
Pierre à repasser  
Piedra afiladora  
Pietra per affilare

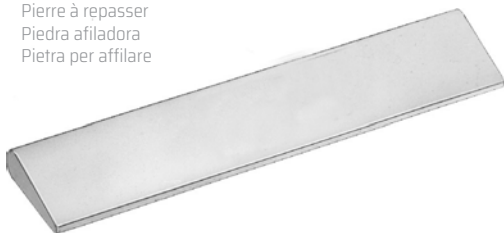

record-arkansas  
GD11.498.00

In wooden case  
im Holzkasten  
en boîte bois  
en caja de madera  
in astuccio di legno



arkansas  
GD11.499.00



Dermatomes  
Dermatome  
Dermatomes  
Dermátomos  
Dermatomi

**GRAND**<sup>®</sup>  
DEVICES  
*The Grand Instruments Company*

Complete with blade  
Komplett mit Klinge  
Complet avec lame  
Completo con hoja  
Completo con lama



**humby**  
**GD11.480.00**  
32.0 cm

Spare Blade  
Ersatzklinge  
Lame de rechange, seule  
Hoja de repuesto  
Lama die ricambio sola



**humby**  
**GD11.480.01**

For usual razor blades  
Für handelsübliche Rasierklingen  
Pour lames de rasoir modèle standard  
Para hojas de afeitar usuales  
Per lamette da barba normali



**silver**  
**GD11.482.19**  
19.0 cm



Adjustable from 0,1 to 2,0 mm  
einstellbar von 0,1 bis 2,0 mm  
réglable en épaisseur de 0,1 à 2,0 mm  
ajustable de 0,1 hasta 2,0 mm  
regolabile da 0,1 a 2,0 mm



Complete  
with 2 skin fixing  
plates and one  
blade

Komplett  
mit 2 Spannplatten  
und einer Klinge

Complet  
avec deux plaque  
pour tendre la peau  
et lame

Completo  
con 2 placas para  
extender la piel y  
una hoja

Completo  
con 2 placche per  
stendere la pelle es  
una lama

**schink**  
**GD11.490.00**  
31.0 cm

Spare Blade  
Ersatzklinge  
Lame de rechange, seule  
Hoja de repuesto  
Lama di ricambio sola



**GD11.490.01**

Skin Fixing Plate  
Spannplatte  
Plaque pour tendre la peau  
Placa para extender la piel  
Placca per stendere la pelle



**GD11.490.02**



Dermatomes  
Dermatome  
Dermatomes  
Dermátomos  
Dermatomi

**GRAND**<sup>®</sup>  
DEVICES  
*The Grand Instruments Company*

Complete with blade  
Komplett mit Klinge  
Complet avec lame  
Completo con hoja  
Completo con lama



**GD11.484.01**

Spare Blade  
Ersatzklinge  
Lame de rechange, seule  
Hoja de repuesto  
Lama di ricambio sola

watson  
**GD11.482.30**  
30.0 cm

Probes, Spatulas, Applicators  
Sonden, Spatel, Watteträger  
Sondes, Spatules, porte-coton  
Sondas, Espátulas, porta-algodón  
Sonde, Spatole, portacotone  
探针·铲子·涂药器



**GD12**





Probes, Directors  
Sonden  
Stylets, sondes  
Sondas, estiletes  
Sonde, specilli

**GRAND**  
DEVICES  
The Grand Instruments Company



2mm Ø      1mm Ø      1.5mm Ø      2mm Ø      DOYEN      STACKE

10.5 cm				GD12.108.10				
11.5 cm	GD12.102.11	GD12.104.11	GD12.105.11	GD12.106.11	GD12.110.11			
13.0 cm	GD12.102.13	GD12.104.13	GD12.105.13	GD12.106.13	GD12.108.13	GD12.110.13	GD12.112.13	GD12.115.10
14.0 cm						GD12.111.14		
14.5 cm	GD12.102.14	GD12.104.14	GD12.105.14	GD12.106.14	GD12.108.14	GD12.110.14	GD12.112.14	
16.0 cm	GD12.102.16	GD12.104.16	GD12.105.16	GD12.106.16	GD12.108.16	GD12.110.16	GD12.112.16	
18.0 cm	GD12.102.18	GD12.104.18	GD12.105.18	GD12.106.18	GD12.108.18	GD12.110.18	GD12.112.18	
20.0 cm	GD12.102.20	GD12.104.20	GD12.105.20	GD12.106.20	GD12.108.20	GD12.110.20		
25.0 cm	GD12.102.25	GD12.104.25	GD12.105.25	GD12.106.25				



**NABATOFF**  
**GD12.150.00**  
135 x 100 x 25 mm  
Compl.



**GD12.150.90**

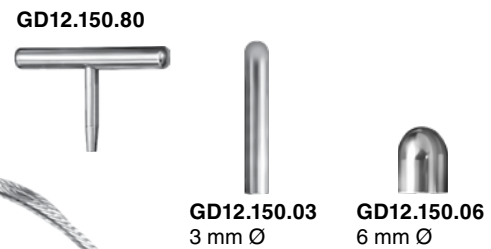

**GD12.150.80**



**GD12.150.03**  
3 mm Ø



**GD12.150.06**  
6 mm Ø

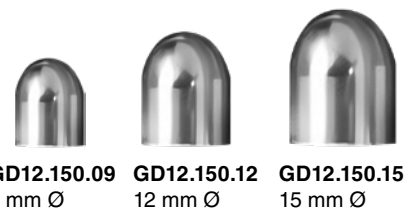

**GD12.150.09**  
9 mm Ø







**GD12.150.12**  
12 mm Ø

**GD12.150.15**  
15 mm Ø

Varicose vein probe set  
Varizenbesteck  
Trousse à varices  
Desobliterador  
Astuccio per varici

Spatulas, Cotton-Applicators  
 Spatel, Watteträger  
 Spatules, porte-coton  
 Espátulas, porta-algodón  
 Spatole, portacotone

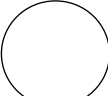

- |                                                                                   |                                                                                   |                                                                                   |                                                                                   |
|-----------------------------------------------------------------------------------|-----------------------------------------------------------------------------------|-----------------------------------------------------------------------------------|-----------------------------------------------------------------------------------|
|  |  |  |                                                                                   |
| <b>GD12.160.04</b><br>4 mm Ø                                                      | <b>GD12.160.06</b><br>6 mm Ø                                                      | <b>GD12.160.07</b><br>7 mm Ø                                                      |                                                                                   |
|  |  |  |  |
| <b>GD12.160.08</b><br>8 mm Ø                                                      | <b>GD12.160.10</b><br>10 mm Ø                                                     | <b>GD12.160.12</b><br>12 mm Ø                                                     | <b>GD12.160.14</b><br>14 mm Ø                                                     |



**GD12.160.04 - GD12.160.14**

Plaster spatula  
 Pflasterspatel  
 Spatules  
 Espátulas  
 Spatole



**GD12.162.12**  
12 cm



13.0 cm **GD12.190.13**  
 14.5 cm **GD12.190.14**

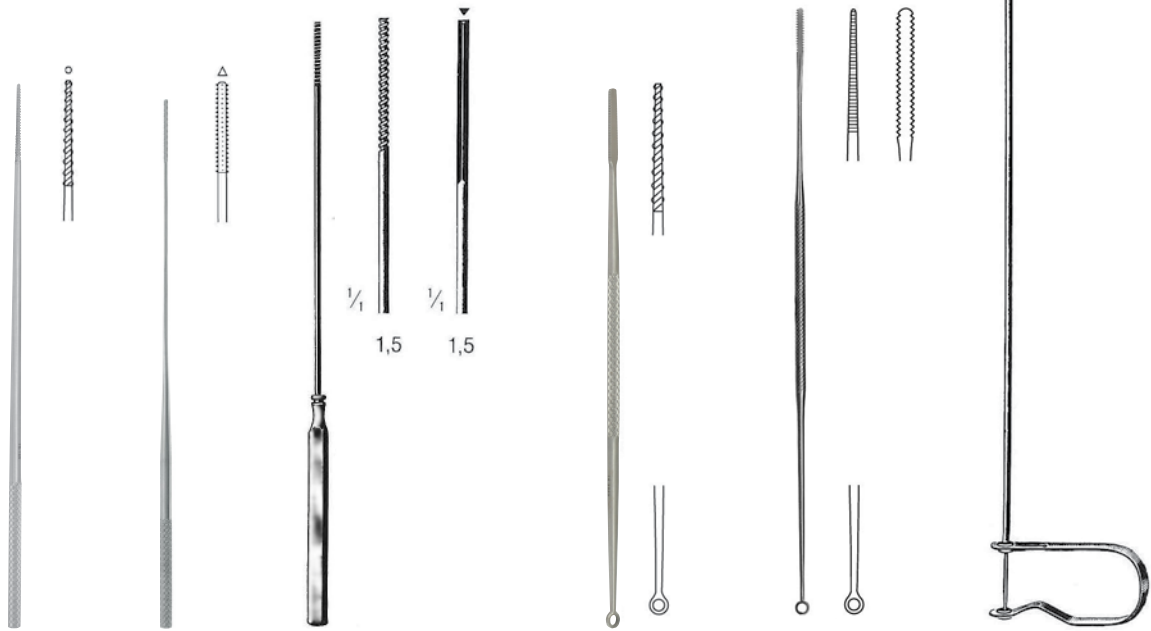

**FARRELL**

**FARRELL**

**UCKERMANN**

**JOBSON-HORNE**

- |         |                    |                    |                    |                    |
|---------|--------------------|--------------------|--------------------|--------------------|
| 12.0 cm | <b>GD12.270.12</b> | <b>GD12.272.12</b> | <b>GD12.290.12</b> | <b>GD12.292.12</b> |
| 14.0 cm | <b>GD12.270.14</b> | <b>GD12.272.14</b> | <b>GD12.290.14</b> | <b>GD12.292.14</b> |
| 15.0 cm |                    |                    |                    |                    |
| 16.0 cm |                    |                    | <b>GD12.290.16</b> | <b>GD12.292.16</b> |
| 16.5 cm | <b>GD12.270.16</b> | <b>GD12.272.16</b> |                    |                    |
| 18.0 cm | <b>GD12.270.18</b> | <b>GD12.272.18</b> | <b>GD12.290.18</b> | <b>GD12.292.18</b> |
| 23.0 cm | <b>GD12.270.23</b> | <b>GD12.272.23</b> |                    |                    |
| 25.0 cm |                    |                    |                    |                    |
| 45.0 cm |                    |                    |                    |                    |

**GD12.310.15**

**GD12.320.12**

**GD12.320.18**

**GD12.340.45**



Spritzen  
Hypodermic Syringes  
Seringues  
Jeringas  
Siringhe



Glass Barrel with Luer connection  
Glaszylinder mit Luer Ansatz  
Cylindre en verre avec raccord Luer  
Cilindro de vidrio con conexión Luer  
Cilindro di vetro con raccordo Luer



01 ml	<b>GD12.500.01</b>
02 ml	<b>GD12.500.02</b>
05 ml	<b>GD12.500.05</b>
10 ml	<b>GD12.500.10</b>
20 ml	<b>GD12.500.20</b>
50 ml	<b>GD12.500.50</b>

Spare Barrel with Luer connection  
Ersatzzylinder mit Luer Ansatz  
Cylindres de rechange avec raccord Luer  
Cilindros de reposito con conexión Luer  
Cilindri di ricambio con raccordo Luer



01 ml	<b>GD12.501.01</b>
02 ml	<b>GD12.502.02</b>
05 ml	<b>GD12.502.05</b>
10 ml	<b>GD12.502.10</b>
20 ml	<b>GD12.502.20</b>
50 ml	<b>GD12.502.50</b>

Glass Barrel with Luer connection  
Glaszylinder mit Luer Ansatz  
Cylindre en verre avec raccord Luer  
Cilindro de vidrio con conexión Luer  
Cilindro di vetro con raccordo Luer



**RECORD**

01 ml	<b>GD12.510.01</b>
02 ml	<b>GD12.510.02</b>
05 ml	<b>GD12.510.05</b>
10 ml	<b>GD12.510.10</b>
20 ml	<b>GD12.510.20</b>
50 ml	<b>GD12.510.50</b>

Spare Barrel with Luer connection  
Ersatzzylinder mit Luer Ansatz  
Cylindres de rechange avec raccord Luer  
Cilindros de reposito con conexión Luer  
Cilindri di ricambio con raccordo Luer



01 ml	<b>GD12.512.01</b>
02 ml	<b>GD12.512.02</b>
05 ml	<b>GD12.512.05</b>
10 ml	<b>GD12.512.10</b>
20 ml	<b>GD12.512.20</b>
50 ml	<b>GD12.512.50</b>

Trocars, Puncture Needles  
Trokare, Punktionsnadeln  
Trocarts, Aiguilles à ponction  
Trócares, Agujas para punción  
Trequarti, Aghi da punzione  
套管针, 穿刺针



**GD13**



Trocars  
Trocare  
Trocarts  
Trócares  
Trequarti

**GRAND**  
DEVICES  
The Grand Instruments Company



Ø 6 mm    4 1/2 mm    3 mm    1 1/2 mm

**Universal**  
**GD13.104.00**  
Compl.



**Standard**  
3.0 mm **GD13.110.30**  
3.5 mm **GD13.110.35**  
4.0 mm **GD13.110.40**  
4.5 mm **GD13.110.45**  
5.0 mm **GD13.110.50**  
5.5 mm **GD13.110.55**  
6.0 mm **GD13.110.60**



**Standard**  
**GD13.120.30**  
**GD13.120.35**  
**GD13.120.40**  
**GD13.120.45**  
**GD13.120.50**  
**GD13.120.55**  
**GD13.120.60**



**PIERCE**  
**GD13.123.30**  
**GD13.123.40**  
**GD13.123.50**



**DOUGLAS**  
**GD13.125.11**  
3 mm Ø

**FLEURANT**  
**GD13.127.23**  
23 cm  
5 mm Ø



**LICHTWITZ**  
**GD13.128.20**  
1.70 mm Ø



**COAKLEY**  
**GD13.140.02**  
2.25 mm Ø



**Charr./**  
**F.G. OCHSNER**  
10 **GD13.150.10**  
12 **GD13.150.12**  
14 **GD13.150.14**  
16 **GD13.150.16**  
18 **GD13.150.18**  
20 **GD13.150.20**



**Charr./**  
**F.G. OCHSNER**  
25 **GD13.170.25**  
30 **GD13.170.30**  
33 **GD13.170.33**  
35 **GD13.170.35**

Trocars, Puncture Needles  
 Trokare, Punktionsnadeln  
 Trocarts, Aiguilles à ponction  
 Trócares, Agujas para punción  
 Trequarti, Aghi da punzione



**GD13.210.00**  
 Compl.



**VERRES**  
**GD13.250.20**  
 2.0 x 100 mm



**QUINKE**  
 1.2 x 76 mm **GD13.230.12**  
 1.2 x 89 mm **GD13.232.12**  
 1.0 x 76 mm **GD13.230.10**  
 1.0 x 89 mm **GD13.232.10**  
 0.7 x 76 mm **GD13.230.07**  
 0.7 x 89 mm **GD13.232.07**



**MENGHINI**  
 1.0 x 35 mm **GD13.302.01**  
 1.0 x 70 mm **GD13.302.02**  
 1.2 x 70 mm **GD13.302.03**  
 1.2 x 100 mm **GD13.302.04**  
 1.4 x 70 mm **GD13.302.05**  
 1.4 x 100 mm **GD13.302.06**  
 1.6 x 70 mm **GD13.302.07**  
 1.8 x 100 mm **GD13.302.08**



**MENGHINI**  
 1.4 x 168 mm **GD13.310.14**  
 1.8 x 168 mm **GD13.310.18**



**MENGHINI**  
**GD13.312.14**  
**GD13.312.18**

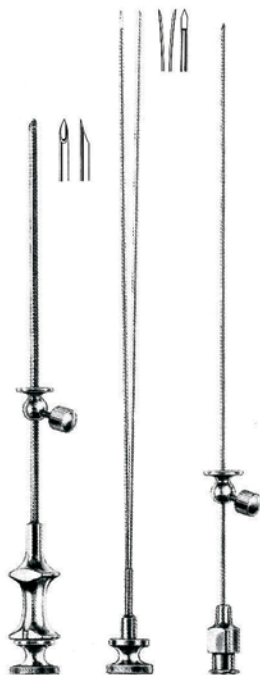

Ø ext.xL.  
 mm  
 2.0 x 105 mm  
 2.0 x 130 mm

Ø int.xL.  
 mm  
 1.5 x 155 mm  
 1.5 x 180 mm  
 compl.

**FRANKLIN-SILVERMANN**

**GD13.230.20**  
**GD13.232.14**

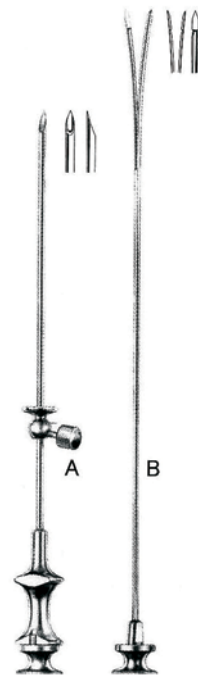

Ø ext. x B.  
 mm  
 2.0 x 100 mm  
 2.5 x 145 mm  
 2.0 x 100 mm  
 2.5 x 145 mm

Ø ext. x L.  
 mm  
 1.5 x 150 mm  
 2.0 x 195 mm  
 1.5 x 150 mm  
 2.0 x 195 mm

A + B  
 B  
**FRANKLIN-SILVERMANN**

**GD13.350.20** **GD13.352.15**  
**GD13.350.30** **GD13.352.20**  
**GD13.354.20** **GD13.356.15**  
**GD13.354.25** **GD13.356.20**



Guide Needles  
Führungsnadeln  
Aiguilles d'introduction  
Agujas de guía  
Aghi conduttori

**GRAND**  
DEVICES  
The Grand Instruments Company



08 Charr. **GD13.400.08**  
10 Charr. **GD13.400.10**  
12 Charr. **GD13.400.12**  
14 Charr. **GD13.400.14**  
16 Charr. **GD13.400.16**  
18 Charr. **GD13.400.18**

slightly curved,  
knife tip, threaded end

leicht gebogen,  
Messerschliff, mit Schraubgewinde

légèrement courbé,  
pointe affûtée, filetée

ligeramente curva,  
punta de cuchillo, roscada

leggermente curvo,  
filo da coltello, con filetto

**REDON**

19.5 cm / 7 $\frac{3}{4}$ "

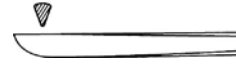

08 Charr. **GD13.401.08**  
10 Charr. **GD13.401.10**  
12 Charr. **GD13.401.12**  
14 Charr. **GD13.401.14**  
16 Charr. **GD13.401.16**  
18 Charr. **GD13.401.18**

fully curved,  
knife tip, threaded end

stark gebogen,  
Messerschliff, mit Schraubgewinde

extrêmement courbé,  
pointe affûtée, filetée

fuertemente curva,  
punta de cuchillo, roscada

fortemente curvo,  
filo da coltello, con filetto

**REDON**

19.5 cm / 7 $\frac{3}{4}$ "



08 Charr. **GD13.402.08**  
10 Charr. **GD13.402.10**  
12 Charr. **GD13.402.12**  
14 Charr. **GD13.402.14**  
16 Charr. **GD13.402.16**  
18 Charr. **GD13.402.18**

slightly curved,  
trocar tip, threaded end

leicht gebogen,  
Dreikantspitze, mit Schraubgewinde

légèrement courbé,  
pointe à trocar, filetée

ligeramente curva,  
punta de trócart, roscada

leggermente curvo,  
punta da trequarti, con filetto

**REDON**

19.5 cm / 7 $\frac{3}{4}$ "

08 Charr. **GD13.403.08**  
10 Charr. **GD13.403.10**  
12 Charr. **GD13.403.12**  
14 Charr. **GD13.403.14**  
16 Charr. **GD13.403.16**  
18 Charr. **GD13.403.18**

slightly curved,  
trocar tip, threaded end

leicht gebogen,  
Dreikantspitze, mit Schraubgewinde

légèrement courbé,  
pointe à trocar, filetée

ligeramente curva,  
punta de trócart, roscada

leggermente curvo,  
punta da trequarti, con filetto

**REDON**

19.5 cm / 7 $\frac{3}{4}$ "

Needle Holders  
Nadelhalter  
Porte-aiguilles  
Porta-agujas  
Port'aghi  
持针器

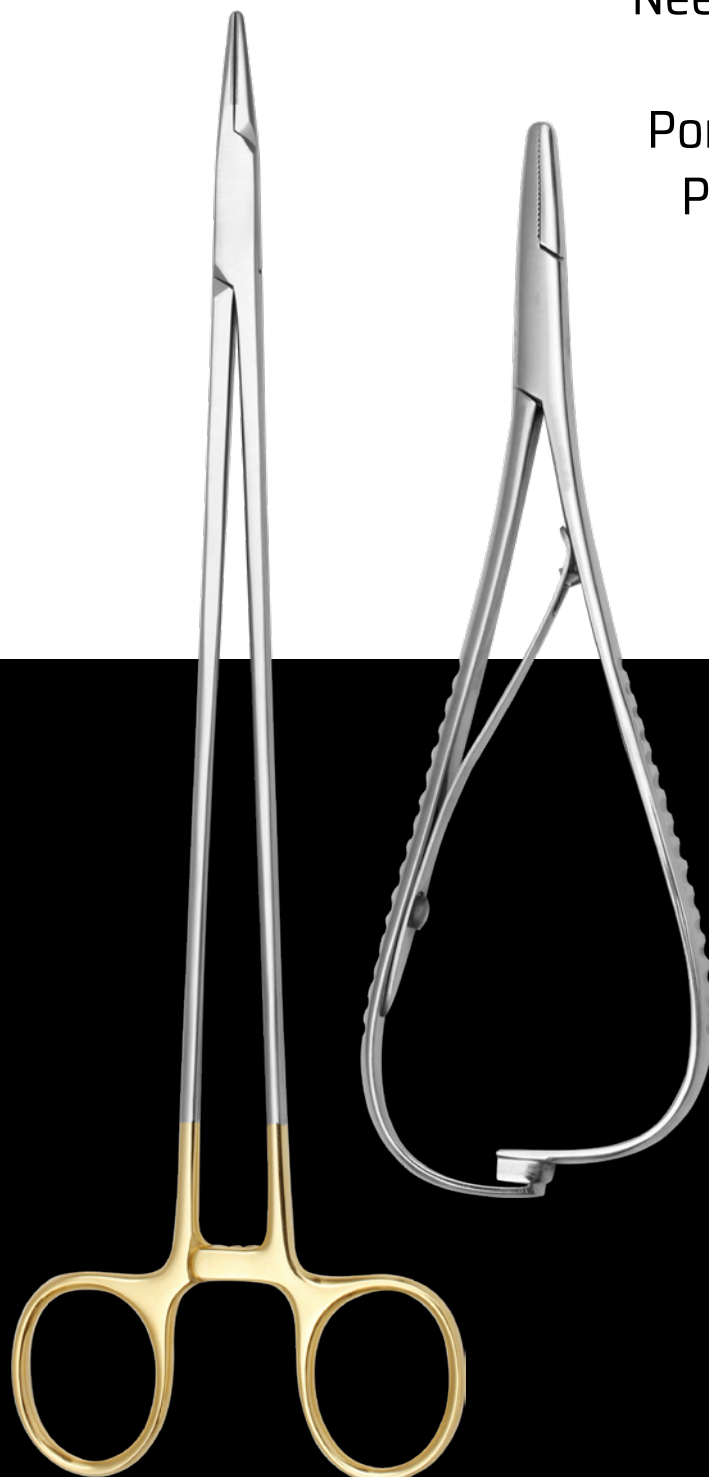

**GD14**





Needle Holders  
Nadelhalter  
Porte-aiguilles  
Porta-agujas  
Port'aghi

**GRAND**  
DEVICES  
The Grand Instruments Company



DERF

GD14.110.12 12.0 cm  GD14.114.12



DERF

12.5 cm GD14.120.12





NEIVERT

13.0 cm GD14.146.13



BAUMGARTNER

GD14.150.12 12.0 cm  GD14.154.12  
GD14.150.14  GD14.154.14



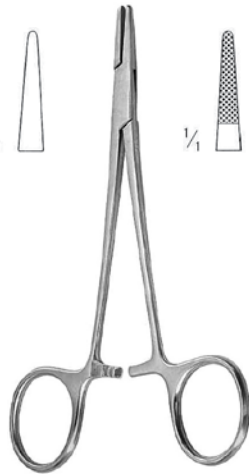

COLLIER

12.5 cm GD14.122.12







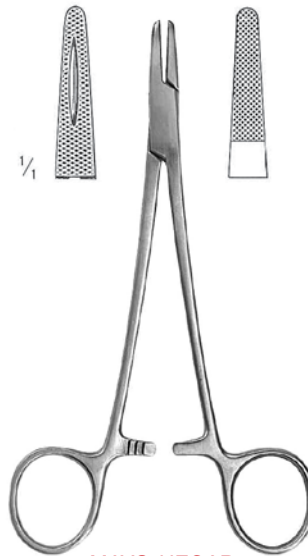

HALSEY

GD14.130.13 13.0 cm GD14.140.13  
GD14.134.13  13.0 cm  GD14.144.13

TC-Lined  
Mit TC-Ensätzen  
A mors TC  
Con bocas TC  
Con morso TC



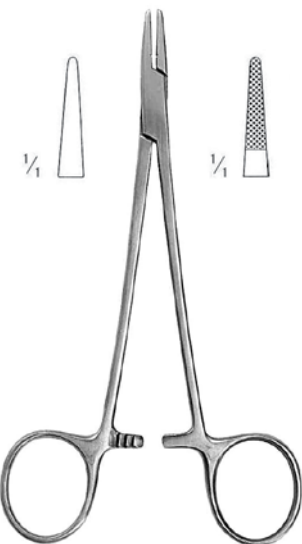

MAYO-HEGAR

GD14.180.14 14.0 cm  GD14.184.14  
GD14.180.16 16.0 cm  GD14.184.16  
GD14.180.18 18.0 cm  GD14.184.18  
GD14.180.20 20.0 cm  GD14.184.20  
GD14.180.24 24.0 cm  GD14.184.24  
GD14.180.26 26.0 cm  GD14.184.26  
GD14.180.30 30.0 cm  GD14.184.30



CRILE-WOOD

GD14.160.15 15.0 cm  GD14.164.15  
GD14.160.18 18.0 cm  GD14.164.18  
GD14.160.20 20.0 cm  GD14.164.20

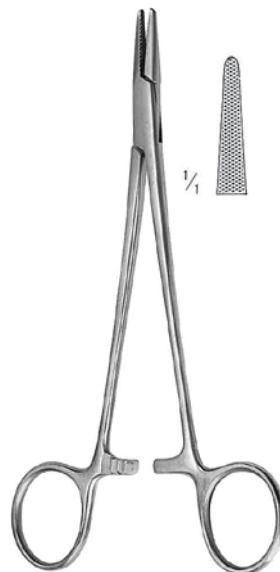

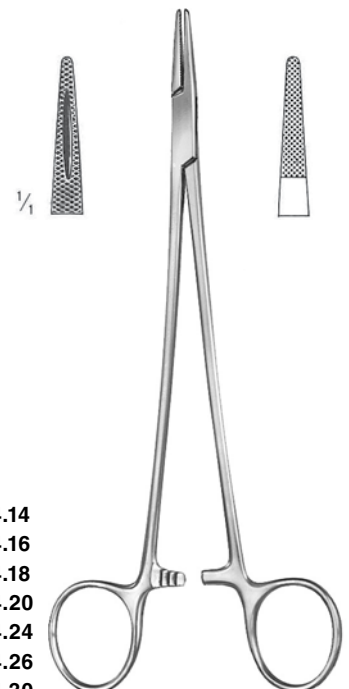

CRILE-MURRAY

GD14.170.15 15.0 cm  GD14.174.15



MAYO-HEGAR

GD14.190.16 16.0 cm  GD14.194.16  
GD14.190.18 18.0 cm  GD14.194.18  
GD14.190.20 20.0 cm  GD14.194.20

Needle Holders  
Nadelhalter  
Porte-aiguilles  
Porta-agujas  
Port'aghi



DE BAKEY

- 15.0 cm ■ **GD14.214.15**
- 18.0 cm ■ **GD14.214.18**
- 20.0 cm ■ **GD14.214.20**
- 23.0 cm ■ **GD14.214.23**
- 26.0 cm ■ **GD14.214.26**
- 31.0 cm ■ **GD14.214.31**
- 37.0 cm ■ **GD14.214.37**

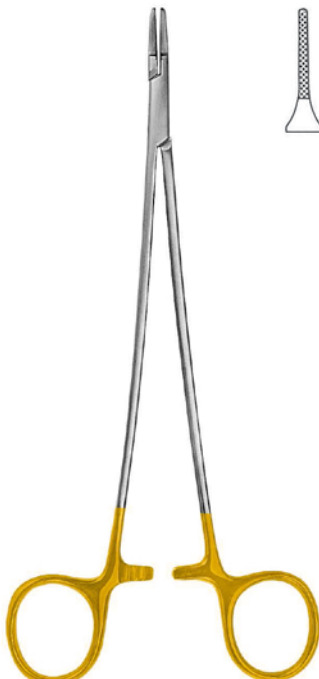

RYDER

- 13.0 cm ■ **GD14.224.13**
- 15.0 cm ■ **GD14.224.15**
- 18.0 cm ■ **GD14.224.18**
- 20.0 cm ■ **GD14.224.20**
- 23.0 cm ■ **GD14.224.23**
- 26.0 cm ■ **GD14.224.26**



JAMISON

- GD14.230.23** 23.5 cm ■ **GD14.234.23**



HEANEY

- GD14.241.21** 21.0 cm ■ **GD14.245.21**

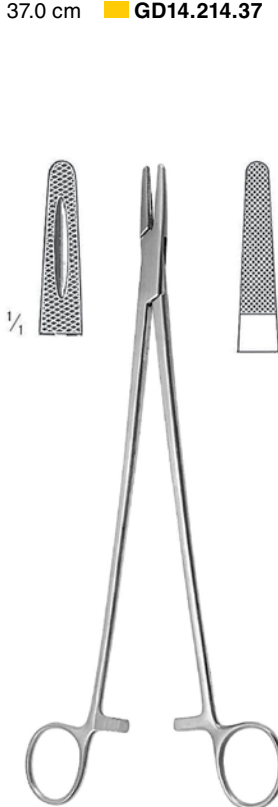

MASSON

- GD14.250.27** 27.0 cm ■ **GD14.254.27**



WANGENSTEEN

- GD14.260.27** 27.0 cm ■ **GD14.264.27**

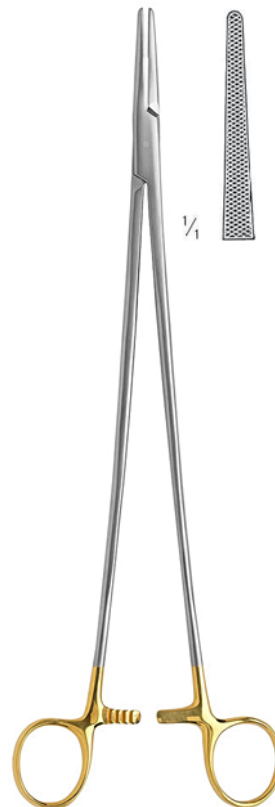

WANGENSTEEN

- GD14.270.27** 27.0 cm ■ **GD14.274.27**

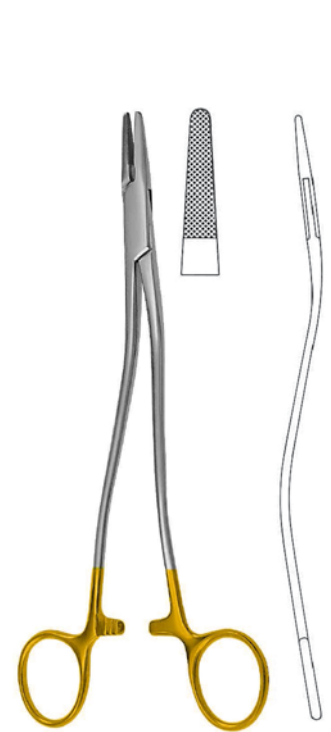

BOZEMANN

- 20.0 cm ■ **GD14.285.20**
- 24.0 cm ■ **GD14.285.24**
- 26.0 cm ■ **GD14.285.26**



Needle Holders  
Nadelhalter  
Porte-aiguilles  
Porta-agujas  
Port'aghi

**GRAND**  
DEVICES  
The Grand Instruments Company

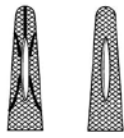

**METZENBAUM**

18.0 cm **GD14.290.18**



**ADSON**

18.0 cm **GD14.292.18**



**JOHNSON**

27.0 cm **GD14.293.27**



**FINOCHIETTO**

**GD14.311.20** 20.0 cm **GD14.315.20**  
**GD14.311.27** 27.0 cm **GD14.315.27**

TC-Lined  
Mit TC-Ensätzen  
A mors TC  
Con bocas TC  
Con morso TC



**SAROT**

**GD14.320.18** 18.0 cm **GD14.355.18**  
**GD14.320.26** 26.0 cm **GD14.355.26**



**STRATTE**

**GD14.330.23** 23.0 cm **GD14.334.23**



**CRILE**

15.0 cm **GD14.350.15**



**TOENNIS**

**GD14.360.18** 18.0 cm **GD14.364.18**

Needle Holders  
Nadelhalter  
Porte-aiguilles  
Porta-agujas  
Port'aghi

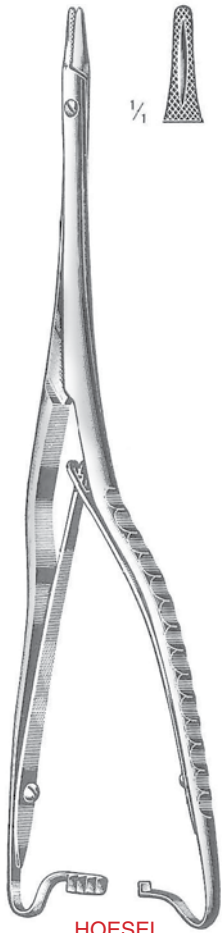

HOESEL

25.0 cm **GD14.366.25**



MATHIEU

14.0 cm **GD14.370.14** **GD14.374.14**  
17.0 cm **GD14.370.17** **GD14.374.17**  
20.0 cm **GD14.370.20** **GD14.374.20**  
24.0 cm **GD14.370.24** **GD14.374.24**



MATHIEU

**GD14.380.17** **GD14.384.17**  
**GD14.384.20** **GD14.384.20**



MATHIEU

**GD14.390.14** **GD14.394.14**  
**GD14.390.17** **GD14.394.17**



OLSEN-HEGAR

**GD14.410.14** 14.0 cm **GD14.414.14**  
**GD14.410.18** 18.0cm **GD14.414.18**



OLSEN-HEGAR

**GD14.420.17** 17.0 cm **GD14.455.17**

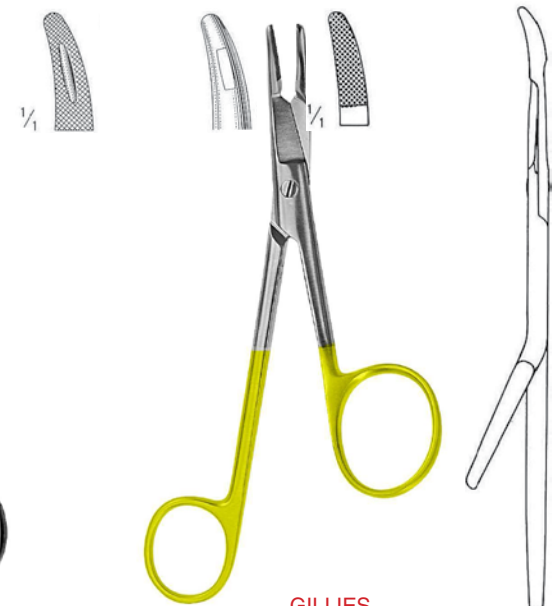

GILLIES

**GD14.430.16** 16.0 cm **GD14.434.16**



Needle Holders  
Nadelhalter  
Porte-aiguilles  
Porta-agujas  
Port'aghi



Vascular surgery  
Gefäß-Chirurgie  
Chirurgie vasculaire  
Chirurgia vascular  
Chirurgia vascolare



TC-Lined  
Mit TC-Einsätzen  
A mors TC  
Con bocas TC  
Con morso TC

**DIETRICH**

- 16.0 cm **GD14.444.16**
- 18.0 cm **GD14.444.18**
- 20.0 cm **GD14.444.20**
- 23.0 cm **GD14.444.23**
- 26.0 cm **GD14.444.26**

Ophthalmology  
Ophthalmologie  
Ophthalmologie  
Oftalmologia  
Oftalmologia



**STEVENS**

11.0 cm **GD14.610.11**



**STEVENS**

13.0 cm **GD14.612.13**  
15.0 cm **GD14.612.15**



**BOYNTON**

12.0 cm **GD14.614.12**



**ARRUGA**

**GD14.620.16** 16.0 cm **GD14.624.16**



**KALT-ARRUGA**

14.0 cm **GD14.627.14**



**KALT**

14.0 cm **GD14.628.14**  
 14.0 cm **GD14.632.14**



**BARRAQUER**

10.0 cm **GD14.650.10**



**BARRAQUER**

10.0 cm **GD14.651.10**



**BARRAQUER**

**GD14.661.13** 13.0 cm **GD14.665.13**



**CASTROVIEJO**

**GD14.670.14** 14.0 cm **GD14.671.14**  
**GD14.674.14** 14.0 cm **GD14.675.14**



**CASTROVIEJO**

**GD14.680.13** 13.0 cm **GD14.684.13**



Sterilizing Aids  
Sterilisierhilfen  
Instrumente pour Sterilisation  
Auxilios para la esterilización  
Utensili per las sterilizzazione  
杀菌剂

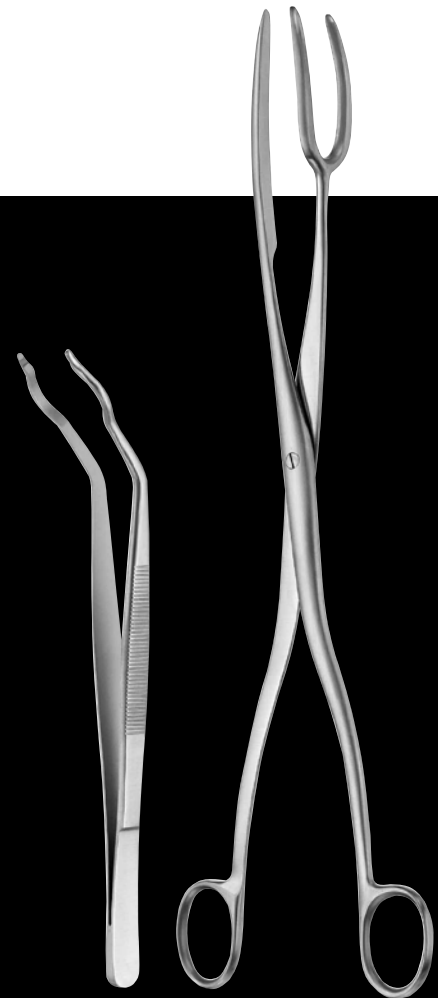

**GD15**





Sterilization Instruments  
Sterilisationsinstrumente  
Instruments à stérilisation  
Instrumentos para esterilización  
Strumenti per la sterilizzazione

**GRAND**  
DEVICES  
*The Grand Instruments Company*



**DAVIS**

16.0 cm **GD15.102.16**  
20.0 cm **GD15.102.20**  
24.0 cm **GD15.102.24**



**CHEATLE**

27.0 cm **GD15.110.27**



**UNIVERSAL**

**GD15.120.20** 20.0 cm **GD15.121.20**  
**GD15.120.28** 28.0 cm **GD15.121.28**



**ROGGE**

23.0 cm **GD15.130.23**



20.0 cm **GD15.140.20**  
30.0 cm **GD15.140.30**



**BUNT**

12.0 cm **GD15.150.12**



**MAYO**

14.0 cm **GD15.152.14**



6x7Z



**SAUERBRUCH**  
55.0 cm **GD15.160.55**

9x10Z



**SAUERBRUCH**  
55.0 cm **GD15.162.55**



**DIMEDA**  
58.0 cm **GD15.170.58**



Cleaning Brushes  
Reinigungsbürsten  
Brosses à lavement  
Cepillos de limpieza  
Spazzole per pulire

**GRAND**  
DEVICES  
*The Grand Instruments Company*



- GD15.315.13** 215 x 60 x 13 mm
- GD15.315.15** 215 x 65 x 15 mm
- GD15.315.20** 215 x 95 x 20 mm
- GD15.315.25** 215 x 95 x 25 mm
- GD15.315.28** 215 x 100 x 28 mm

Set of 5 brushes      GD15.315.13 - GD15.315.28  
Satz mit 5 Bürsten      GD15.315.13 - GD15.315.28  
jeu de 5 brosses      GD15.315.13 - GD15.315.28  
juego de 5 cepillos      GD15.315.13 - GD15.315.28  
set a 5 spazzole      GD15.315.13 - GD15.315.28

**GD15.315.00**



**GD15.318.12**  
275x65x12 mm



**GD15.318.15**  
275x80x15 mm



**GD15.318.30**  
300x120x30 mm



**GD15.318.50**  
320x130x50 mm



**GD15.324.35**  
360x140x35 mm



**GD15.326.40**  
420x180x40 mm



**GD15.327.60**  
500x180x40 mm



**GD15.333.80**  
 490x180x80 mm



**GD15.335.60**  
 450x180x60 mm



**GD15.340.75**  
 420x130x75 mm



**GD15.351.50**  
 330x130x50 mm

conical  
 konisch  
 conique  
 cónico  
 conico



**GD15.356.15**  
 400x190x8/20 mm



**GD15.359.18**  
 300x110x18/33 mm



**GD15.361.15**  
 320x70x15/25 mm



**GD15.365.08**  
 420x60x8/15 mm



**GD15.367.15**  
 1000x180x16 mm



**GD15.370.95**  
 210x95 mm



Towel Clamps  
Tuchklemmen  
Pincès à champs  
Pinzas para campos  
Pinze Fissateli  
杀菌剂

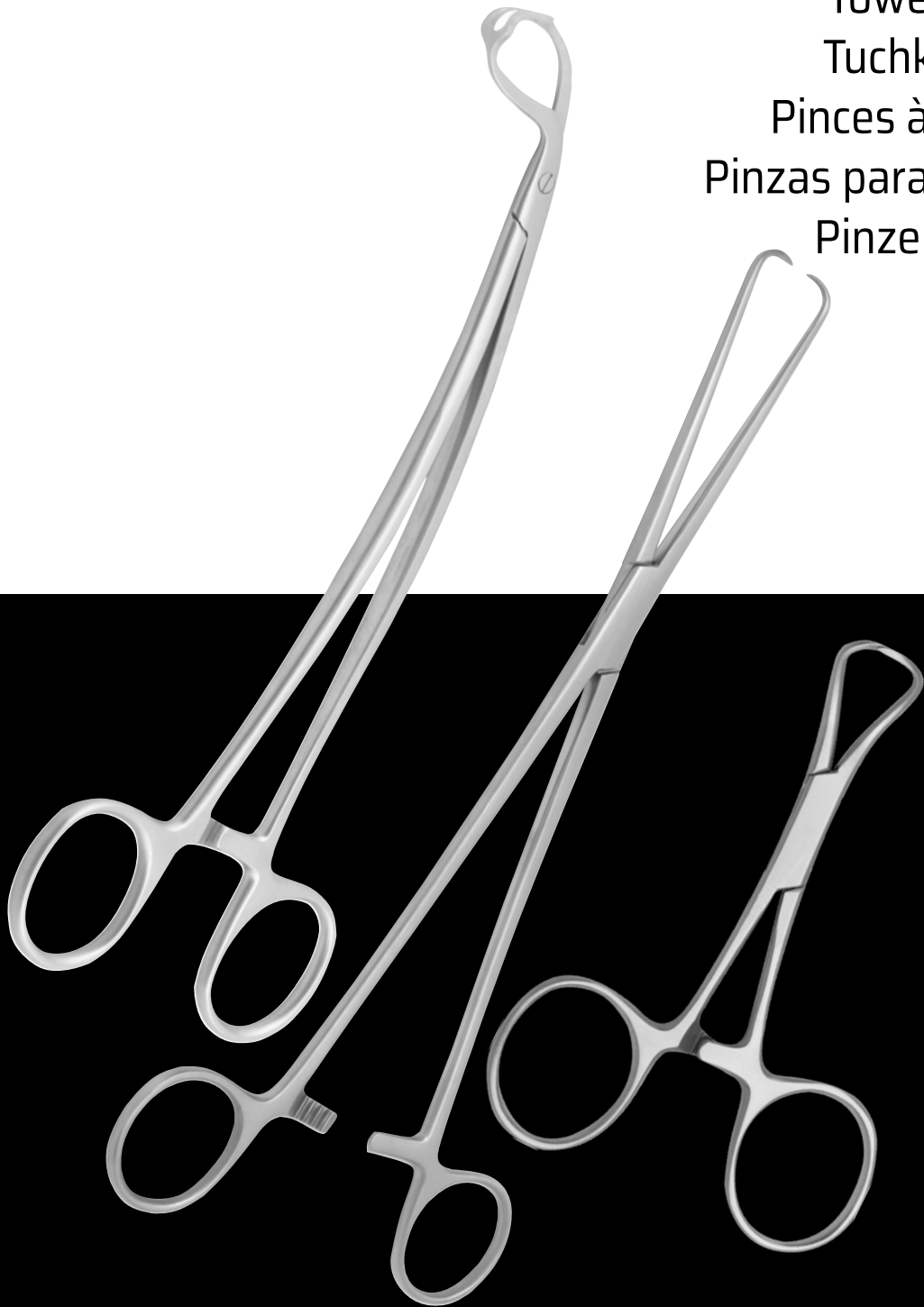

**GD16**



Towel Clamps  
Tuchklemmen  
Pinces à champs  
Pinzas para campos  
Pinze fissateli



sharp  
scharf  
aigüe  
aguda  
acute



**SCHAEDEL**  
09.0 cm **GD16.101.09**

sharp  
scharf  
aigüe  
aguda  
acute



**JONES**  
05.0 cm **GD16.103.05**  
09.0 cm **GD16.103.09**

sharp  
scharf  
aigüe  
aguda  
acute



**JONES-CLIP**  
09.0 cm **GD16.105.09**

with tube holder  
mit Schlauchhalter  
avec clamp porte-tube  
con porta-tubo  
con porta tubo



**BACKHAUS**  
09.0 cm **GD16.111.09**  
11.0 cm **GD16.111.11**  
13.0 cm **GD16.111.13**  
15.0 cm **GD16.111.15**



delicate model  
graziles Modell  
modèle gracile  
modelo delicato  
modello delicato

11.0 cm **GD16.112.11**  
13.0 cm **GD16.112.13**



**BACKHAUS KOCHER**  
13.0 cm **GD16.113.13**



with tube holder  
mit Schlauchhalter  
avec clamp porte-tube  
con porta-tubo  
con porta tubo

**BACKHAUS-CLIP**

11.0 cm **GD16.115.11**  
13.0 cm **GD16.115.13**  
15.0 cm **GD16.115.15**



**ROEDER**

13.0 cm **GD16.117.13**  
15.0 cm **GD16.117.15**

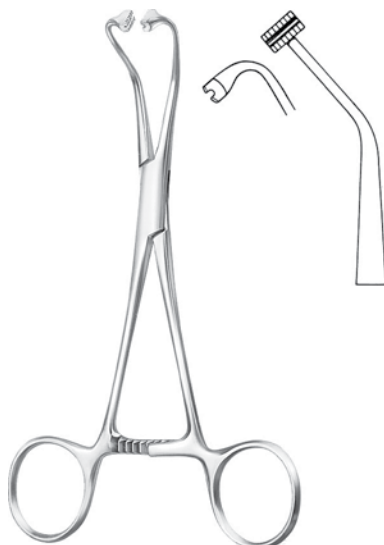

wide jaw for tube fixation  
weites Maul zur Schlauchfixierung  
mors large pour fixation de tube  
boca ancha para fijación de tubos  
morso spalancato per fissare il tubo

**PEERS BERTRAM**

14.0 cm **GD16.118.14**



for paper clothes  
für Papierabdeckung  
pour couverture en papier  
para paños de papel per  
copertura di carta

**HOOF**

10.0 cm **GD16.119.10**  
12.0 cm **GD16.119.12**  
14.0 cm **GD16.119.14**





Towel Clamps  
Tuchklemmen  
Pinces à champs  
Pinzas para campos  
Pinze fissateli

**GRAND**  
DEVICES  
*The Grand Instruments Company*

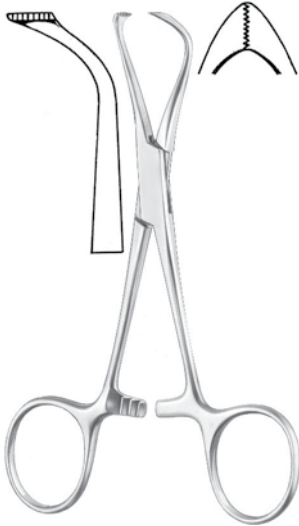

fine serrated, wide jaw  
fein gezahnt, breites Maul  
cuors large avec deuts fins  
boca anca, delicadamente dentada  
marso largo, con denti fini

**LORNA**

9.0 cm **GD16.121.09**  
10.0 cm **GD16.121.10**  
11.0 cm **GD16.121.11**  
13.0 cm **GD16.121.13**

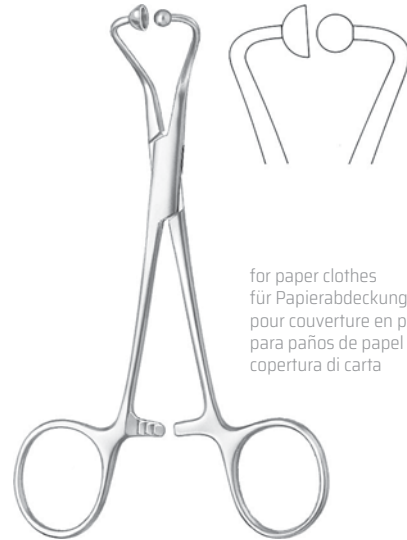

for paper clothes  
für Papierabdeckung  
pour couverture en papier  
para paños de papel per  
copertura di carta

**BALL AND SOCKET**

09.0 cm **GD16.123.09**  
10.0 cm **GD16.123.10**  
11.0 cm **GD16.123.11**  
13.0 cm **GD16.123.13**  
14.0 cm **GD16.123.14**  
16.0 cm **GD16.123.16**

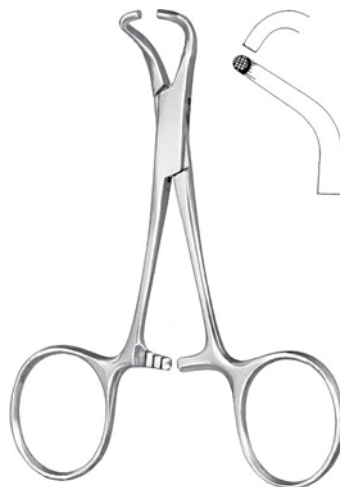

**TOHOKU**

10.0 cm **GD16.127.10**  
13.0 cm **GD16.127.13**



**BERNHARD**

16.5 cm **GD16.140.16**  
18.0 cm **GD16.140.18**



**MOYNIHAN**

19.0 cm **GD16.150.19**



**DOYEN**

14.0 cm **GD16.161.14**  
18.0 cm **GD16.161.18**



**LANE**

13.0 cm **GD16.164.13**  
15.0 cm **GD16.164.15**  
20.0 cm **GD16.164.20**



Suture  
Naht  
Suture  
Sutura  
Sutura  
缝线

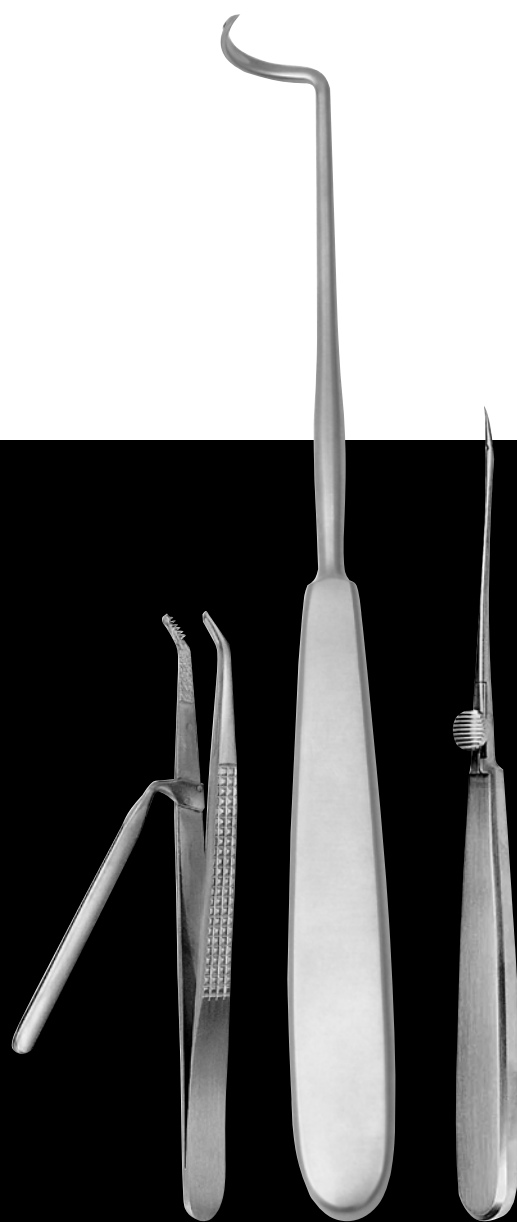

**GD17**



Ligature Needles  
 Unterbindungsnadeln  
 Aiguilles à ligatures  
 Agujas para ligaduras  
 Aghi per legature

**GRAND**  
 DEVICES  
 The Grand Instruments Company

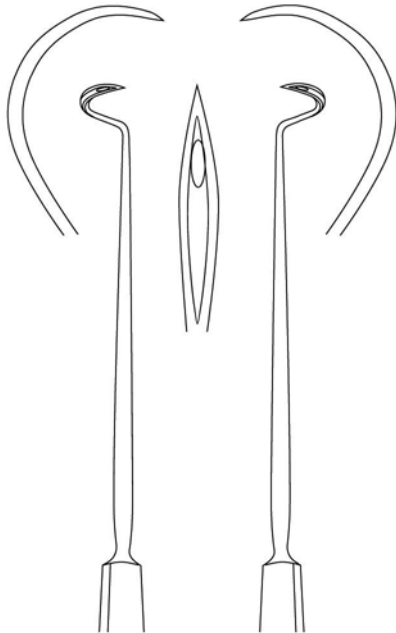

R **DESCHAMPS** L

GD17.110.21 21.0 cm GD17.111.21  
 GD17.110.24 24.0 cm GD17.111.24  
 GD17.110.27 27.0 cm GD17.111.27

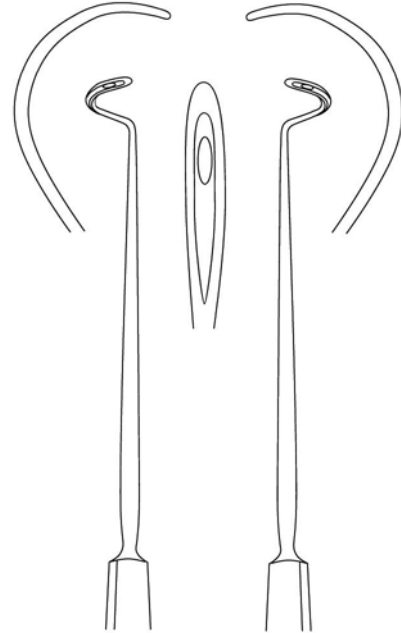

R **DESCHAMPS** L

GD17.120.21 21.0 cm GD17.121.21  
 GD17.120.24 24.0 cm GD17.121.24  
 GD17.120.27 27.0 cm GD17.121.27



R **KRONECKER** L

GD17.130.13 13.0 cm GD17.131.13

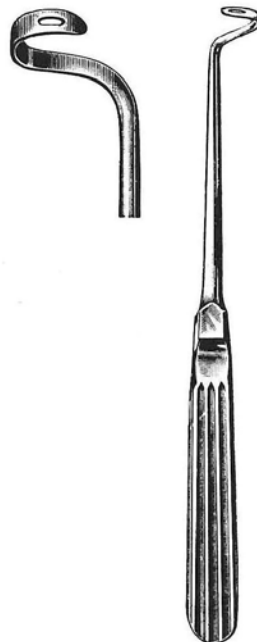

R **NELSON** L

GD17.133.24 24.5 cm GD17.135.24

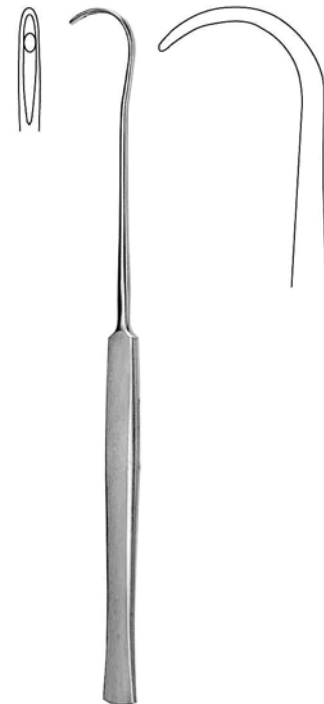

**COOPER**

19.0 cm GD17.139.19



**REVERDIN**

15.0 cm **GD17.201.15**  
 23.0 cm **GD17.204.23**



**Fig. 1**

15.0 cm **GD17.201.15**  
 19.0 cm **GD17.201.19**  
 21.0 cm **GD17.201.21**  
 23.0 cm **GD17.201.23**



**Fig. 2**

**GD17.202.15**  
**GD17.202.19**  
**GD17.202.21**  
**GD17.202.23**



**Fig. 3**

**GD17.203.15**  
**GD17.203.19**  
**GD17.203.21**  
**GD17.203.23**



**Fig. 4**

**GD17.204.15**  
**GD17.204.19**  
**GD17.204.21**  
**GD17.204.23**



**YOUNG Boomerang**

25.0 cm **GD17.240.00**



**Fig. 1**  
**GD17.240.01**



**Fig. 2**  
**GD17.240.02**

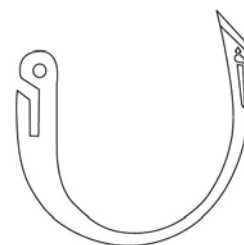

**Fig. 3**  
**GD17.240.03**



Ligature Conductors  
 Führungs-Hohlsonden  
 Sondes conductrices  
 Sondas conductoras  
 Sonde conduttrici

**GRAND**  
 DEVICES  
 The Grand Instruments Company



**SCHMIEDEN**

19.0 cm **GD17.271.19**



**SCHMIEDEN-PAYR**

19.0 cm **GD17.273.19**



**BRUNNER**

30.0 cm **GD17.275.30**



**KIRSCHNER**

25.5 cm **GD17.277.25**



**KOENIG**

20.0 cm **GD17.285.20**



**PAYR**

22.0 cm **GD17.288.22**



**PAYR**

22.0 cm **GD17.289.22**



**BRUNNER**

18.0 cm **GD17.291.18**

27.0 cm **GD17.291.27**

From plastic material  
 Plastik  
 matière plastique  
 de materia plástica  
 in plastica

Suturing Needles  
 Nähadeln  
 Aiguilles à sutures  
 Agujas para suturas  
 Aghi per suture

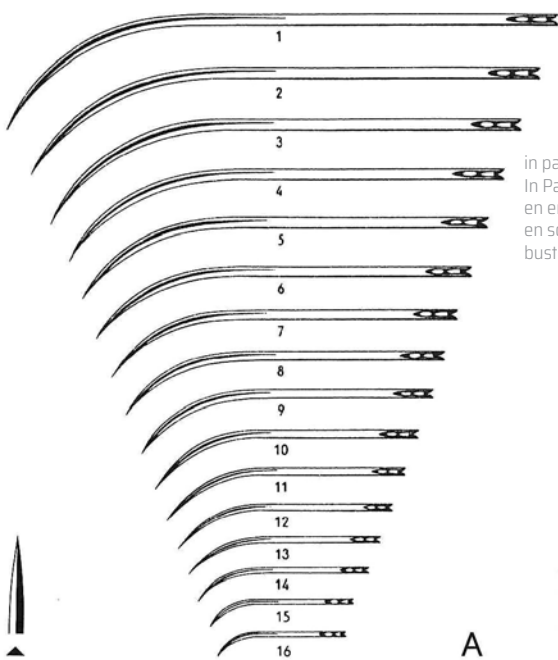

in packages of 1 dozen  
 In Packungen zu 1 Dutzend  
 en enveloppes de 1 douzaine  
 en sobres de 1 dozena  
 bustine di 1 dozzina

GD17.403.01 - GD17.403.16

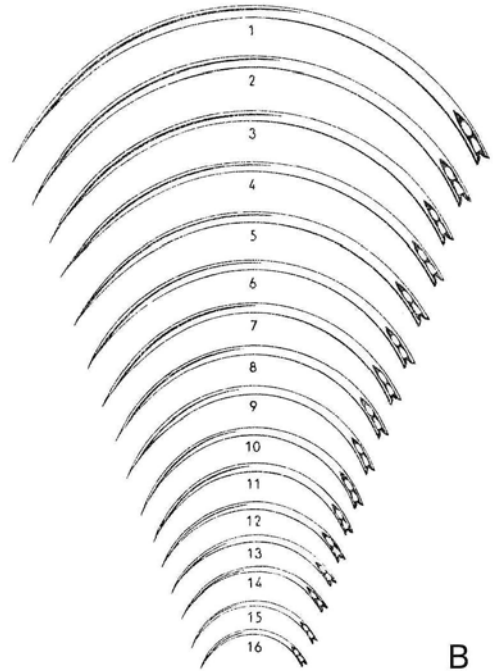

GD17.413.01 - GD17.413.16

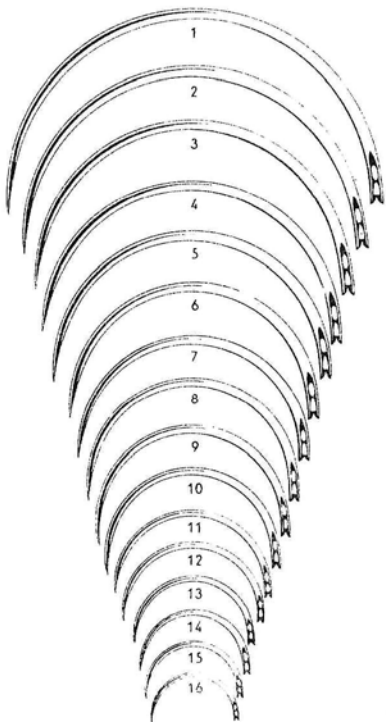

All the needles with spring eye  
 Alle Nadeln mit Federöhr  
 toutes les aiguilles à chas à ressort  
 todas las agujas con ojo de resorte  
 tutti gli aghi con cruna aperta

GD17.423.01 - GD17.423.16

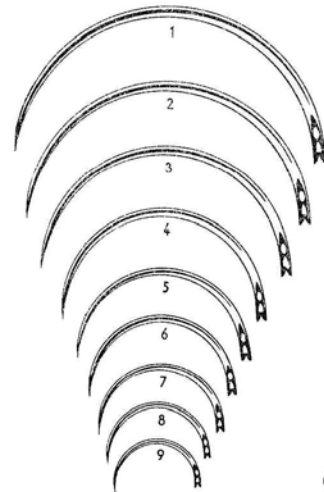

GD17.433.01 - GD17.433.09

Fig. 1 2 3 4 5 6 7 8 9 10 11 12 13 14 15 16

- A GD17.403.01 GD17.403.02 GD17.403.03 GD17.403.04 GD17.403.05 GD17.403.06 GD17.403.07 GD17.403.08 GD17.403.09 GD17.403.10 GD17.403.11 GD17.403.12 GD17.403.13 GD17.403.14 GD17.403.15 GD17.403.16
- B GD17.413.01 GD17.413.02 GD17.413.03 GD17.413.04 GD17.413.05 GD17.413.06 GD17.413.07 GD17.413.08 GD17.413.09 GD17.413.10 GD17.413.11 GD17.413.12 GD17.413.13 GD17.413.14 GD17.413.15 GD17.413.16
- G GD17.423.01 GD17.423.02 GD17.423.03 GD17.423.04 GD17.423.05 GD17.423.06 GD17.423.07 GD17.423.08 GD17.423.09 GD17.423.10 GD17.423.11 GD17.423.12 GD17.423.13 GD17.423.14 GD17.423.15 GD17.423.16
- GA GD17.433.01 GD17.433.02 GD17.433.03 GD17.433.04 GD17.433.05 GD17.433.06 GD17.433.07 GD17.433.08 GD17.433.09





Suturing Needles  
 Nähnadeln  
 Aiguilles à sutures  
 Agujas para suturas  
 Aghi per suture

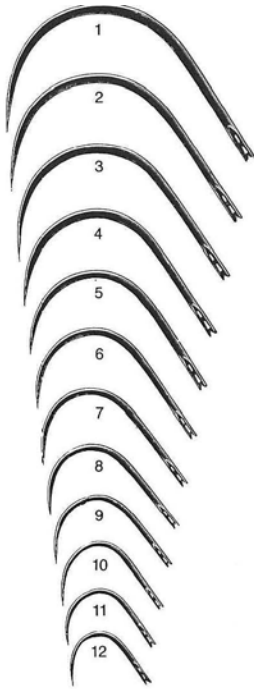

**KOENIG**  
 GD17.441.01 - GD17.441.12

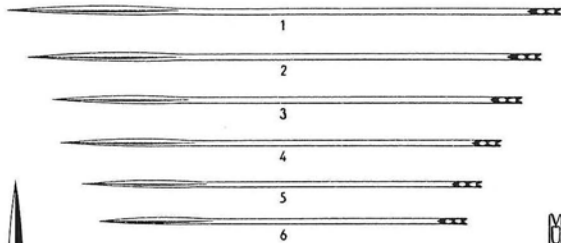

**KEITH**  
 GD17.450.01 - GD17.450.06

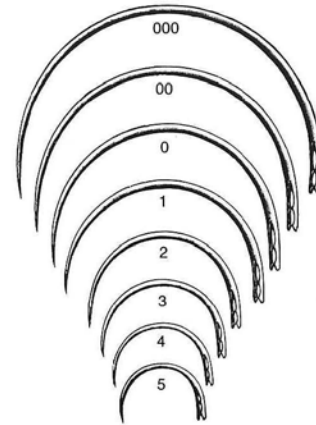

GD17.443.30 - GD17.443.05

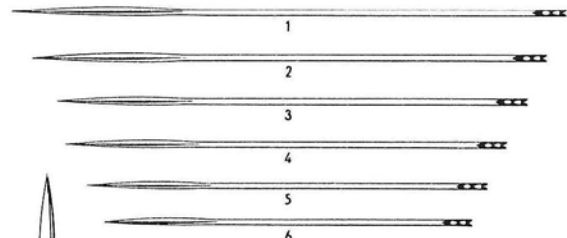

**KEITH**  
 GD17.452.01 - GD17.452.06

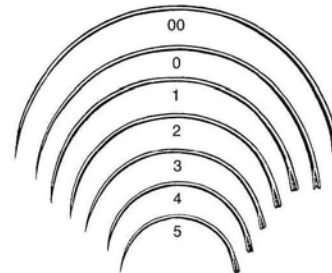

GD17.465.20 - GD17.467.05 **Pb**

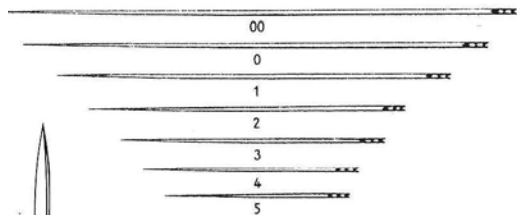

GD17.475.20 - GD17.477.05

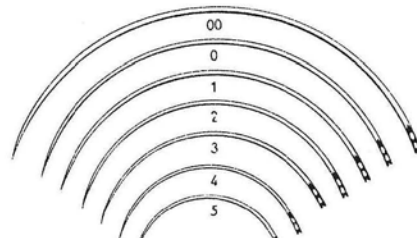

GD17.485.20 - GD17.487.05 **Pd**



All the needles with spring eye  
 Alle Nadeln mit Federrohr  
 toutes les aiguilles à chas à ressort  
 todas las agujas con ojo de resorte  
 tutti gli aghi con cruna aperta

Fig. 000 00 0 1 2 3 4 5 6 7 8 9 10 11 12

KOENIGE	GD17.441.01	GD17.441.02	GD17.441.03	GD17.441.04	GD17.441.05	GD17.441.06	GD17.441.07	GD17.441.08	GD17.441.09	GD17.441.10	GD17.441.11	GD17.441.12
	GD17.443.30	GD17.443.20	GD17.443.10	GD17.443.01	GD17.443.02	GD17.443.03	GD17.443.04	GD17.443.05				
KEITH	GD17.450.01	GD17.450.02	GD17.450.03	GD17.450.04	GD17.450.05	GD17.450.06						
KEITH	GD17.452.01	GD17.452.02	GD17.452.03	GD17.452.04	GD17.452.05	GD17.452.06						
Pb	GD17.465.20	GD17.465.10	GD17.467.01	GD17.467.02	GD17.467.03	GD17.467.04	GD17.467.05	GD17.467.06	GD17.467.07	GD17.467.08		
Pc	GD17.475.20	GD17.475.10	GD17.477.01	GD17.477.02	GD17.477.03	GD17.477.04	GD17.477.05					
Pd	GD17.485.20	GD17.485.10	GD17.487.01	GD17.487.02	GD17.487.03	GD17.487.04	GD17.487.05					

Clips and Instruments  
Wundklammern,-instrumente  
Agrafes et instruments  
Agrafes e instrumentos  
Agrafes e strumenti



**MICHEL**  
12.0 cm **GD17.610.12**



**WACHENFELDT**  
12.5 cm **GD17.612.12**



**WACHENFELDT**  
12.5 cm **GD17.614.12**



**HEGENBARTH**  
12.5 cm **GD17.616.12**



**CHILDE**  
18.0 cm **GD17.620.18**



**MICHEL**  
12.0 cm **GD17.630.12**



**MICHEL**  
13.0 cm **GD17.631.13**



**COLLIN**  
13.0 cm **GD17.640.13**



**RICHTER-HEATH**  
14.0 cm **GD17.642.14**



	7.5 x 1.75mm	<b>GD17.660.07</b>
	11 x 2 mm	<b>GD17.660.11</b>
	12 x 3 mm	<b>GD17.660.12</b>
	14 x 3 mm	<b>GD17.660.14</b>
	16 x 3 mm	<b>GD17.660.16</b>
	18 x 3 mm	<b>GD17.660.18</b>
	20 x 3 mm	<b>GD17.660.20</b>
	22 x 3 mm	<b>GD17.660.22</b>



Pocket, Suturing Kits  
Taschen-, Nahtbesteck  
Trousse à poche et à suture  
Estuche de bolsillo y de sutura  
Astucci tascabili e per sutura

**GRAND**  
DEVICES  
*The Grand Instruments Company*

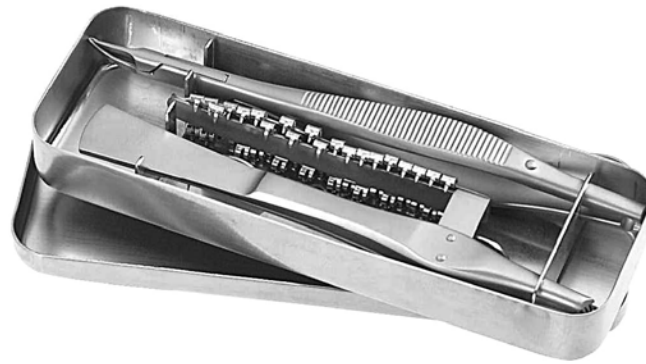

**MINI**

**GD17.670.00**

130 x 45 x 18 mm



**STANDARD**

**GD17.680.00**

165 x 90 x 28 mm

Retractors  
Wundhaken  
Ecarteurs  
Separadores  
Divaricatori  
牵开器



**GD18**



Retractors  
Wundhaken  
Ecarteurs  
Separadores  
Divaricatori

**GRAND**  
The DEVICES



**FARABUEF**

12.0 cm **GD18.102.12**



**FARABUEF**

15.0 cm **GD18.102.15**



**PARKER**

13.5 cm **GD18.110.13**



**PARKER**

18.0 cm **GD18.110.18**



**ROUX**

**GD18.120.00**

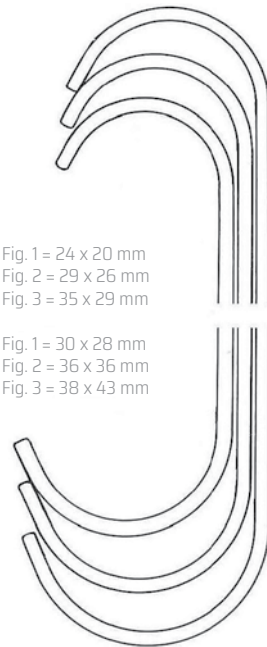

Fig. 1 = 24 x 20 mm  
Fig. 2 = 29 x 26 mm  
Fig. 3 = 35 x 29 mm

Fig. 1 = 30 x 28 mm  
Fig. 2 = 36 x 36 mm  
Fig. 3 = 38 x 43 mm

**Fig.**

<b>GD18.120.14</b>	1	14.0 cm
<b>GD18.120.15</b>	2	15.0 cm
<b>GD18.120.17</b>	3	17.0 cm



**ROUX Baby**

13.0 cm **GD18.122.13**

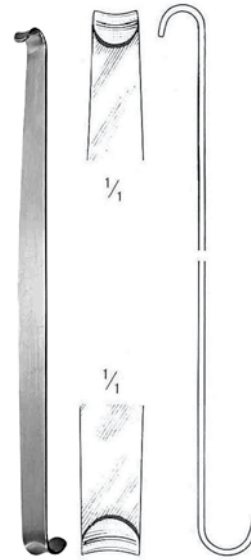

**ROUX mini**

15.0 cm **GD18.124.15**



**CRILE**

11.5 cm **GD18.127.11**

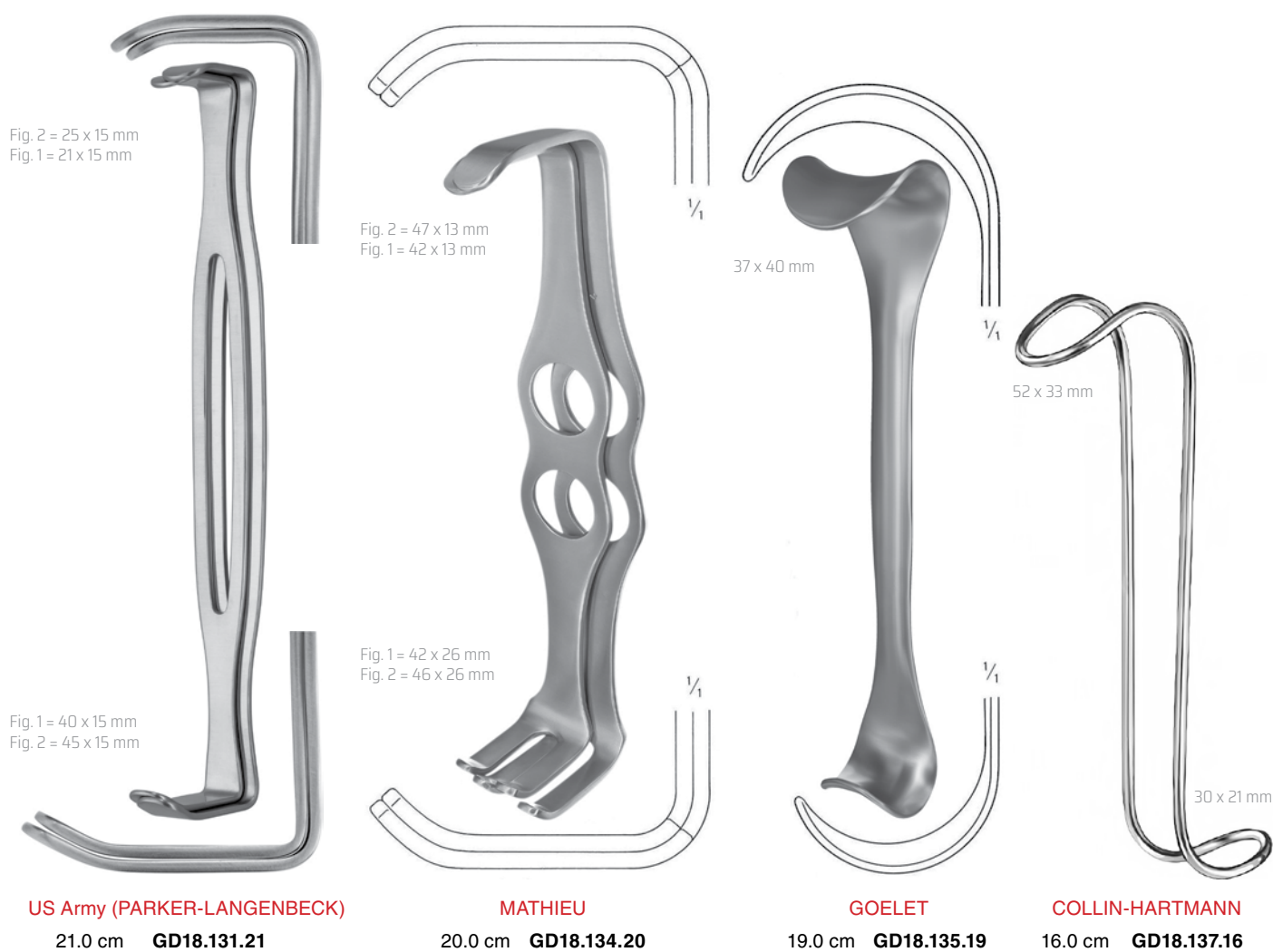





Retractors  
Wundhaken  
Ecarteurs  
Separadores  
Divaricatori

**GRAND**  
DEVICES  
*The Grand Instruments Company*



**RICHARDSON-EASTMANN**  
GD18.140.00

GD18.150.01  
28 x 20 mm

GD18.150.02  
36 x 28 mm

GD18.150.03  
44 x 38 mm



**RICHARDSON**



**RICHARDSON Grip**



65 x 50 mm

**KELLY**



**KELLY Grip**

20 x 25 mm **GD18.1GD18.25**  
25 x 31 mm **GD18.1GD18.31**  
38 x 38 mm **GD18.1GD18.38**  
(Append.) 19 x 51 mm **GD18.1GD18.51**  
41 x 64 mm **GD18.1GD18.64**

26.0 cm **GD18.156.26** 38 x 51 mm **GD18.158.51**  
51 x 64 mm **GD18.158.64**  
64 x 76 mm **GD18.158.76**  
70 x 82 mm **GD18.158.82**

7 x 8.5 mm

7 x 8.5 mm

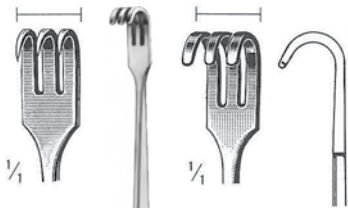

**SENN**

GD18.160.17 17.0 cm GD18.161.17



**RIBBON**

12 x 200 mm **GD18.168.12**  
17 x 200 mm **GD18.168.17**  
25 x 250 mm **GD18.168.25**



**RIBBON**

25 x 330 mm **GD18.170.25**  
32 x 330 mm **GD18.170.32**  
40 x 330 mm **GD18.170.40**  
50 x 330 mm **GD18.170.50**



**HABERER**

17/25 x 200 mm **GD18.174.17**  
25/30 x 250 mm **GD18.174.25**  
37/45 x 300 mm **GD18.174.37**



**REVERDIN**

28.0 cm **GD18.175.28**



19 mm



**DEAVER**  
**GD18.180.19**  
19 x 180 mm

22 mm



**DEAVER**  
**GD18.181.22**  
22 x 215 mm

25 mm



**DEAVER**  
**GD18.181.25**  
25 x 230 mm

25 mm



**DEAVER**  
**GD18.183.25**  
25 x 300 mm

25 mm



**DEAVER**  
**GD18.185.25**  
25 x 330 mm

25 mm



**DEAVER**  
**GD18.187.25**  
25 x 360 mm

38 mm



**DEAVER**  
**GD18.187.38**  
38 x 300 mm

50 mm



**DEAVER**  
**GD18.187.50**  
50 x 300 mm

75 mm



**DEAVER**  
**GD18.187.75**  
75 x 315 mm



**DEAVER Grip**  
**GD18.189.25** 25 x 310 mm  
**GD18.189.38** 38 x 310 mm  
**GD18.189.50** 50 x 310 mm



**HAMINGTON**  
**GD18.191.25** 24 x 70 mm  
**GD18.191.40** 44 x 137 mm  
**GD18.191.62** 65 x 137 mm





Retractors  
Wundhaken  
Ecarteurs  
Separadores  
Divaricatori

**GRAND**  
DEVICES  
*The Grand Instruments Company*



**GRAEFE**  
GD18.210.12



**GRAEFE**  
GD18.211.12



**GUTHRIE**  
GD18.212.01



**GUTHRIE**  
GD18.212.02



**FRAZIER**  
13.0 cm GD18.214.13  
18.0 cm GD18.214.18



GD18.216.01



GD18.216.02  
2.0 mm



GD18.216.05  
5.0 mm



GD18.216.07  
7.0 mm



GD18.216.10  
10.0 mm



**JOSEPH**  
16.0 cm



GD18.220.01



GD18.220.02



GD18.220.03



GD18.220.04



GD18.221.01



GD18.221.02

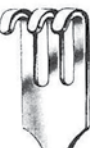

GD18.221.03



GD18.221.04



GD18.226.02



GD18.226.03



GD18.226.04



GD18.227.02



GD18.227.03



GD18.227.04



**DESMARRES**  
16.0 cm

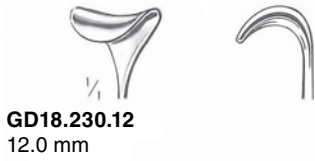

**GD18.230.12**  
12.0 mm



**GD18.230.14**  
14.0 mm



**GD18.230.16**  
16.0 mm



**GD18.230.18**  
18.0 mm



**CUSHING**  
20.0 cm



**GD18.232.08**  
8.0 mm



**GD18.232.10**  
10.0 mm



**GD18.232.12**  
12.0 mm



**GD18.232.14**  
14.0 mm



**GD18.232.16**  
16.0 mm



**GD18.232.18**  
18.0 mm



**CUSCHING**  
20.0 cm **GD18.234.20**



**CUSCHING**  
21.5 cm **GD18.234.21**

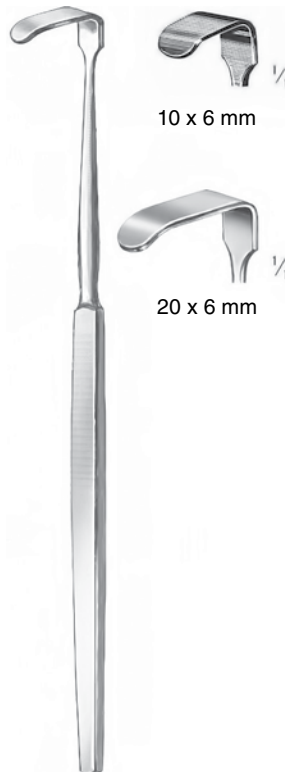

**SENN-GREEN**  
10 x 6 mm **GD18.240.10**  
20 x 6 mm **GD18.240.20**



**VOLKMANN**  
11.5 cm



**GD18.270.02**



**GD18.271.02**



**GD18.270.03**



**GD18.271.03**



**GD18.270.04**



**GD18.271.04**



**GD18.270.06**



**GD18.271.06**



Retractors  
Wundhaken  
Ecarteurs  
Separadores  
Divaricatori

**GRAND**  
DEVICES  
*The Grand Instruments Company*



**VOLKMANN**  
21.5 cm



GD18.280.01



GD18.280.02



GD18.280.03



GD18.280.04



GD18.280.06



GD18.281.01



GD18.281.02



GD18.281.03



GD18.281.04



GD18.281.06



**MEYERDING**  
18.0 cm



18 x 7 mm GD18.302.01



16 x 5 mm GD18.302.02



7 x 4 mm GD18.302.03



7 x 4 mm GD18.302.04



10 x 3 mm GD18.302.05



10 x 4 mm GD18.302.06

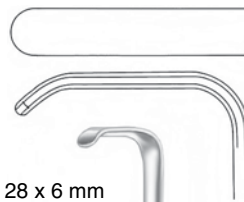

28 x 6 mm



**LAHEY**  
19.0 cm GD18.304.19



12 x 14 mm



**LITTLE**  
20.0 cm GD18.306.20

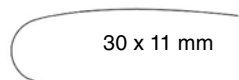

GD18.310.01  
GD18.312.01

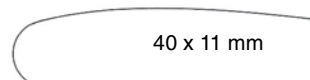

GD18.310.04  
GD18.312.04

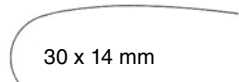

GD18.310.02  
GD18.312.02

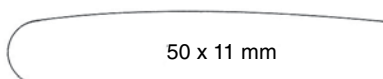

GD18.310.05  
GD18.312.05

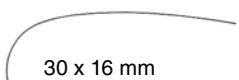

GD18.310.03  
GD18.312.03

LANGENBECK

GD18.310.01 - GD18.310.05  
22.0 cm

LANGENBECK

GD18.312.01 - GD18.312.05  
21.0 cm



60 x 20 mm GD18.314.20

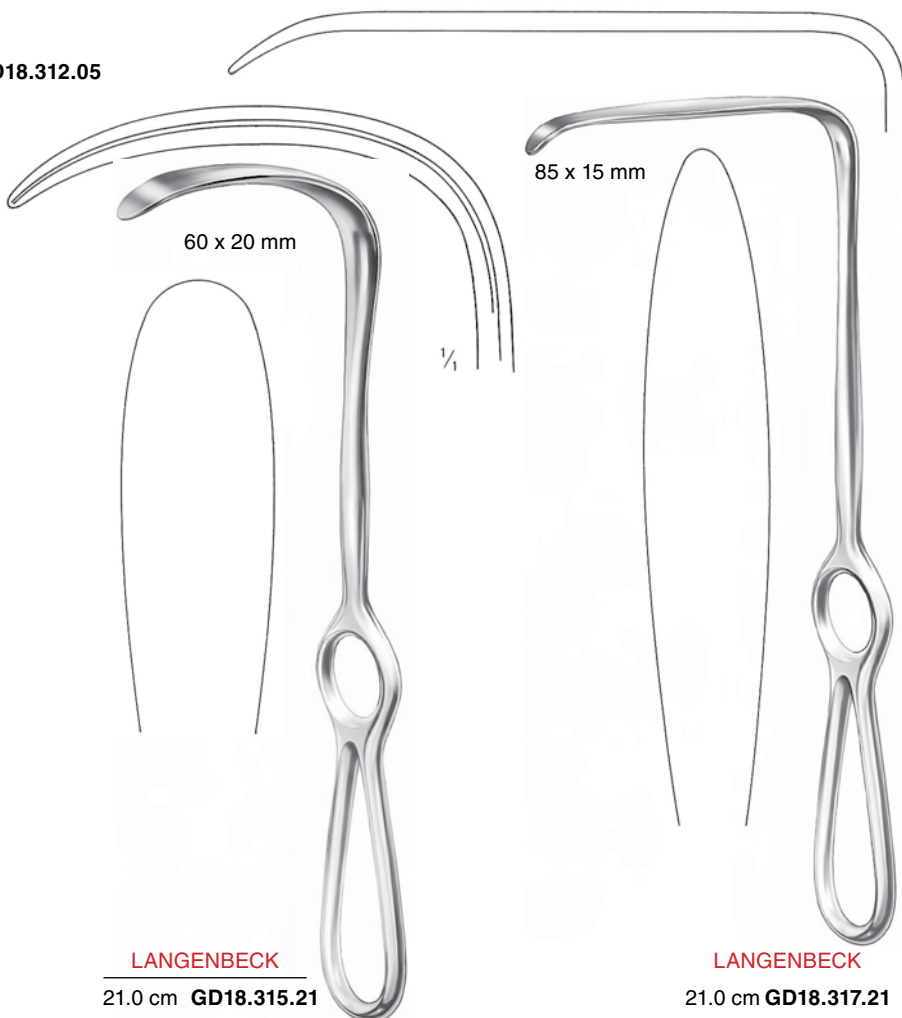

60 x 20 mm

LANGENBECK

21.0 cm GD18.315.21

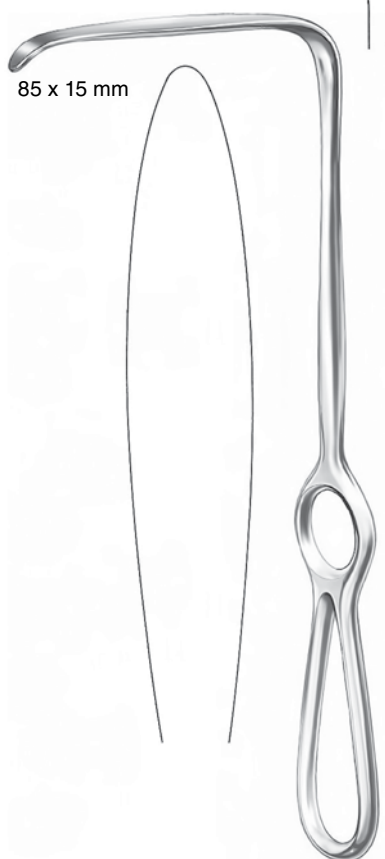

85 x 15 mm

LANGENBECK

21.0 cm GD18.317.21



35 x 7 mm GD18.314.07



35 x 10 mm GD18.314.10



35 x 15 mm GD18.314.15

LANGENBECK

21.0 cm GD18.314.07 - GD18.314.20



Retractors  
Wundhaken  
Ecarteurs  
Separadores  
Divaricatori

**GRAND**  
DEVICES  
The Grand Instruments Company



78 x 40 mm **GD18.318.78**

57 x 25 mm **GD18.318.57**

40 x 18 mm **GD18.318.40**

**KOCHER**

**GD18.318.40 - GD18.318.78**  
23.0 cm



40 x 12 mm **GD18.330.40**

55 x 11 mm **GD18.330.55**

**KOCHER**

**GD18.330.40 - GD18.330.55**  
19.0 cm

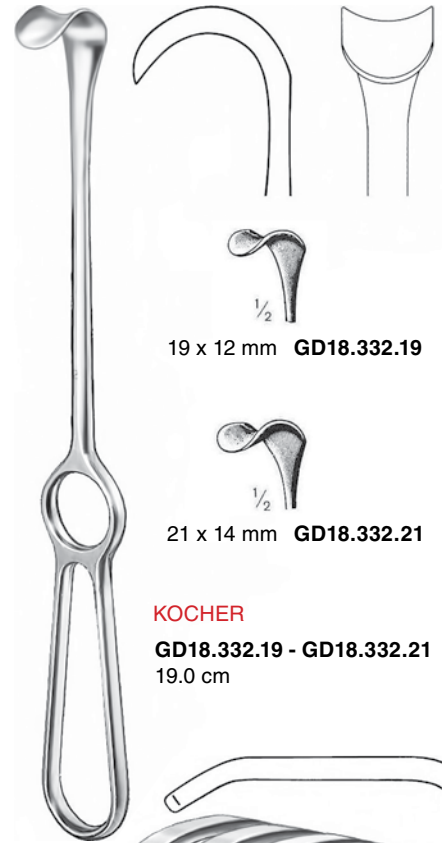

19 x 12 mm **GD18.332.19**

21 x 14 mm **GD18.332.21**

**KOCHER**

**GD18.332.19 - GD18.332.21**  
19.0 cm



**KOCHER**

40 x 10 mm **GD18.340.10**  
40 x 15 mm **GD18.340.15**  
40 x 20 mm **GD18.340.20**  
22.0 cm



**GD18.344.14**  
14 x 17 mm  
21.5 cm

**GD18.344.20**  
20 x 22 mm  
22.0 cm

**GD18.344.26**  
26 x 30 mm  
23.5 cm

**MIDDELDORPF**

**GD18.344.14 - GD18.344.26**



**GREEN**

22.0 cm **GD18.348.22**



**OLLIER**

22.5 cm **GD18.360.04**



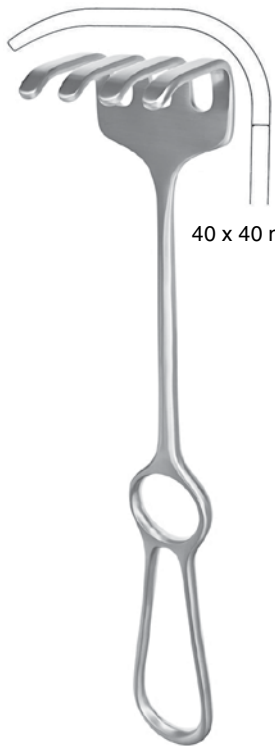

40 x 40 mm **GD18.364.40**

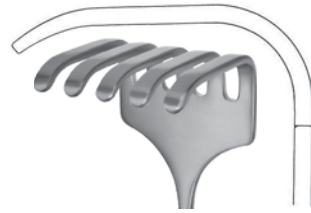

45 x 50 mm **GD18.364.50**

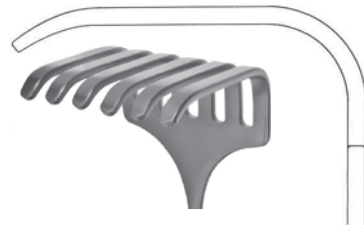

50 x 60 mm **GD18.364.60**



70 x 70 mm **GD18.364.70**

**ISRAEL**  
25.0 cm

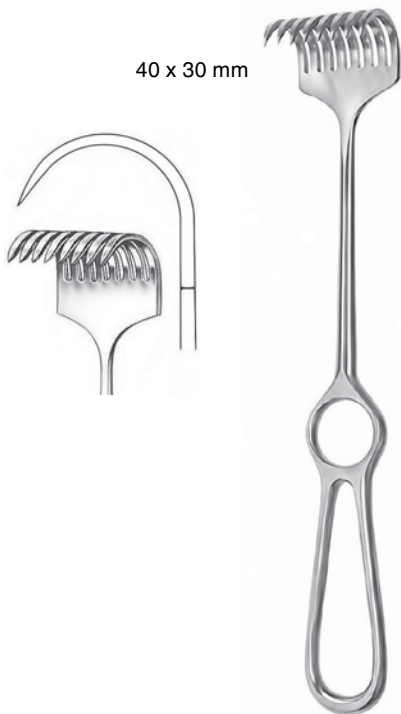

40 x 30 mm

**KOERTE**  
**GD18.366.08** 23.5 cm **GD18.367.08**



**FRITSCH**  
45 x 40 mm **GD18.370.40**  
45 x 50 mm **GD18.370.50**  
45 x 60 mm **GD18.370.60**  
45 x 75 mm **GD18.370.75**  
24.0 cm



70 x 25 mm

**KOCHER**  
22.5 cm **GD18.372.22**



**KOCHER**  
80 x 45 mm **GD18.374.45**  
80 x 55 mm **GD18.374.55**  
80 x 65 mm **GD18.374.65**  
25.0 cm



Retractors  
Wundhaken  
Ecarteurs  
Separadores  
Divaricatori

**GRAND**  
DEVICES  
The Grand Instruments Company



50 x 85 mm

**DOYEN**

25.0 cm **GD18.378.25**

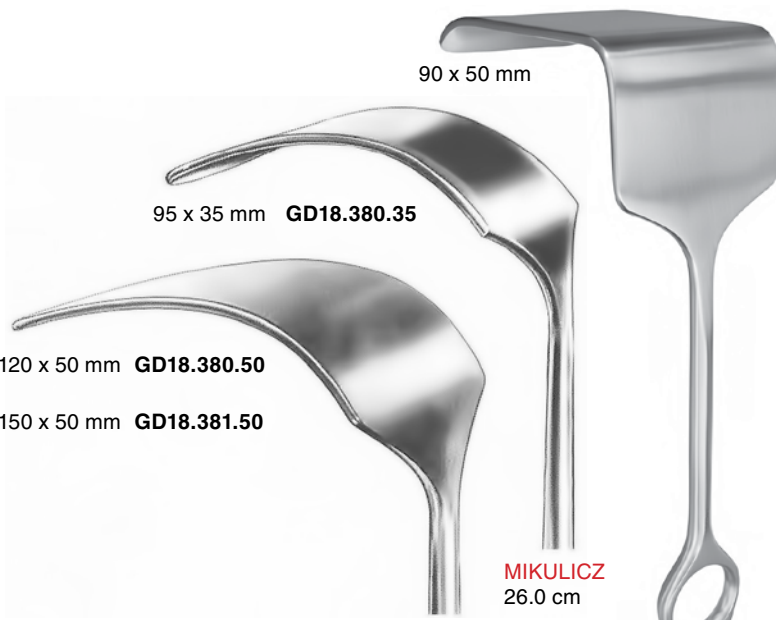

90 x 50 mm

95 x 35 mm **GD18.380.35**

120 x 50 mm **GD18.380.50**

150 x 50 mm **GD18.381.50**

**MIKULICZ**  
26.0 cm

**MIKULICZ**  
26.0 cm

**MIKULICZ**

26.0 cm **GD18.382.50**



**KELLY**

160 x 38 mm **GD18.385.38**  
160 x 57 mm **GD18.385.57**  
27.0 cm



**SIMON**

115 x 22 mm **GD18.480.22**  
115 x 27 mm **GD18.480.27**  
28.0 cm



**GD18.482.82**  
82 x 28 mm

**GD18.482.73**  
73 x 28 mm

**GD18.482.45**  
45 x 25 mm

1/2

1/2

**HEANEY**

27.0 cm **GD18.482.45 - GD18.482.82**



115 x 65 mm **GD18.490.65**

108 x 43 mm **GD18.490.43**

82 x 22 mm **GD18.490.22**



125 x 37 mm

**SAUERBRUCH**

25.0 cm **GD18.492.25**

**CORYLLOS (Thorax)**

24.0 cm **GD18.490.22 - GD18.490.65**



45 x 15 mm **GD18.494.45**

60 x 23 mm **GD18.494.60**

75 x 20 mm **GD18.494.75**

**SAUERBRUCH**

22.5.0 cm **GD18.494.45 - GD18.494.75**



**DAVIDSON (Scapula)**

75 x 50 mm **GD18.496.50**



**DAVIDSON (Scapula)**

75 x 90 mm **GD18.496.90**





Retractors  
Wundhaken  
Ecarteurs  
Separadores  
Divaricatori

**GRAND**  
DEVICES  
The Grand Instruments Company

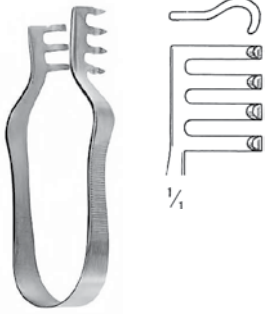

**FINSEN**

GD18.610.07 7.0 cm GD18.611.07

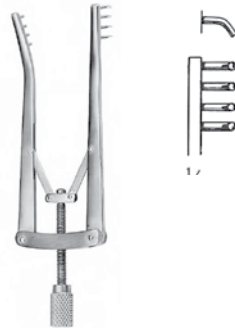

**ALM**

GD18.620.07 7.0 cm GD18.621.07  
GD18.620.10 10.0 cm GD18.621.10



**JANSEN**

10.0 cm GD18.630.10



**JANSEN**

10.0 cm GD18.631.10



**DIMEDA**

GD18.634.10 10.0 cm GD18.635.10



**WEITLANER**

GD18.650.10 11.5 cm GD18.651.10



**WEITLANER-WULLSTEIN**

GD18.654.13 13.0 cm GD18.655.13



**PLESTER**

11.0 cm GD18.657.11



**PLESTER**

11.0 cm GD18.659.11



**WEITLANER**

GD18.670.14 14.0 cm GD18.671.14  
GD18.670.16 16.5 cm GD18.671.16  
GD18.670.20 20.0 cm GD18.671.20



**ADSON**  
GD18.680.19 19.0 cm GD18.681.19

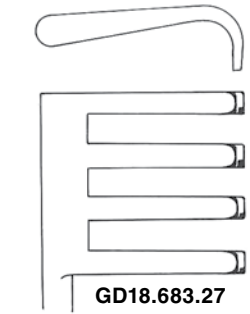
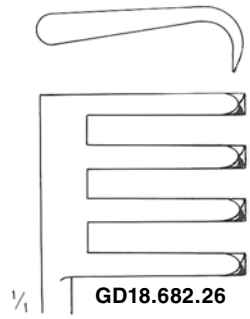

**ADSON**  
26.5 cm GD18.682.26 - GD18.683.26

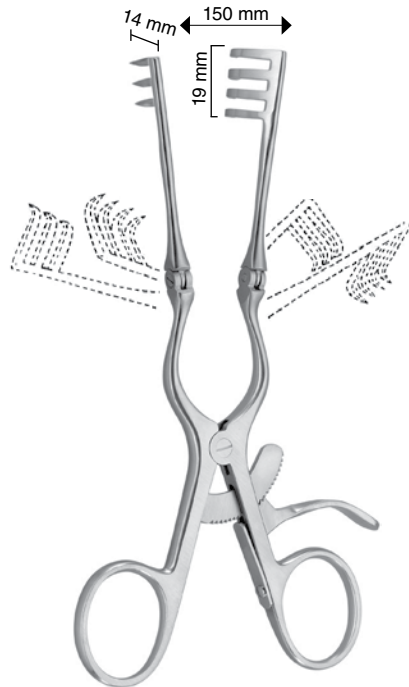

**ADSON Baby**  
16.0 cm GD18.684.16 - GD18.685.16

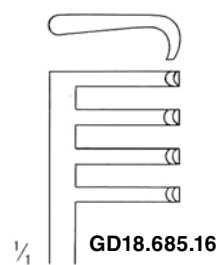
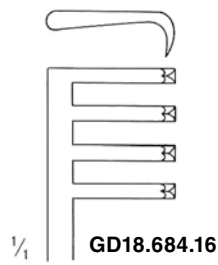

**BECKMANN-ADSON**  
32.0 cm GD18.686.32



Retractors  
Wundhaken  
Ecarteurs  
Separadores  
Divaricatori

**GRAND**  
DEVICES  
*The Grand Instruments Company*



**BECKMANN**

31.0 cm **GD18.690.31**

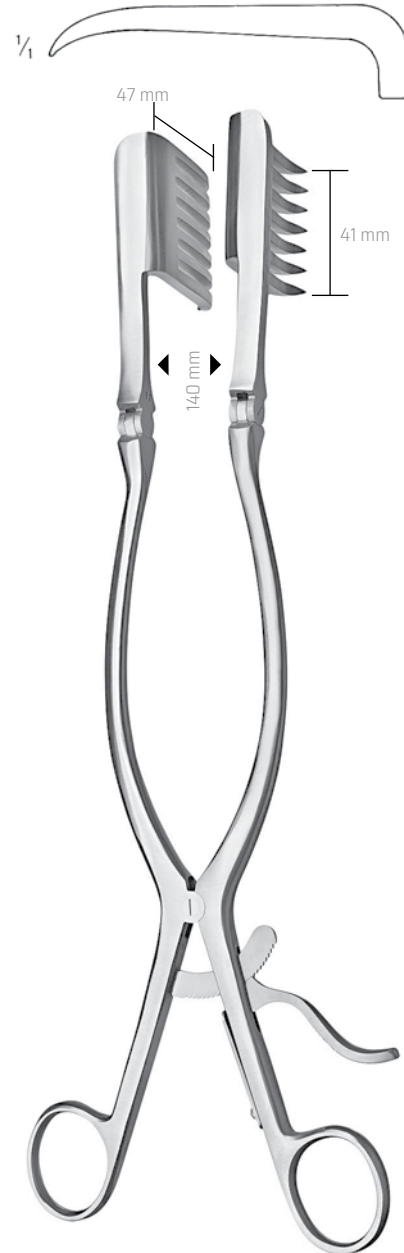

**BECKMANN-EATON**

32.0 cm **GD18.692.32**



**MOLLISON**  
15.0 cm **GD18.693.15**



**DARLING**  
18.0 cm **GD18.696.18**

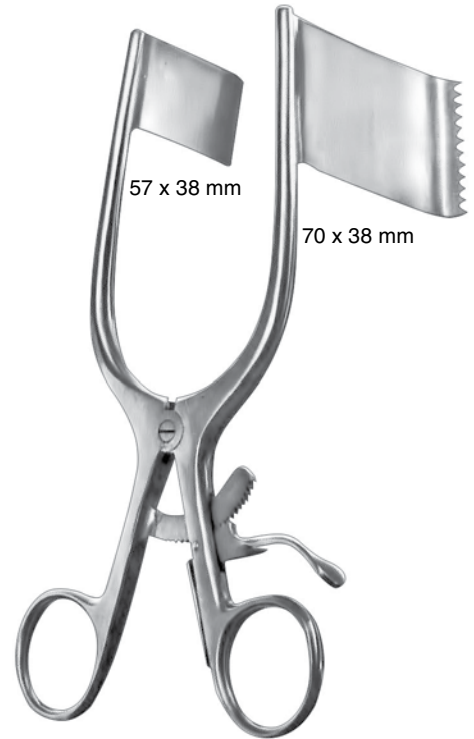

**DARLING**  
18.0 cm **GD18.698.18**



**CLOWARD**  
**GD18.710.00 - GD18.710.01**  
without blades • ohne Valvensans  
valves • sin valves • senza valve

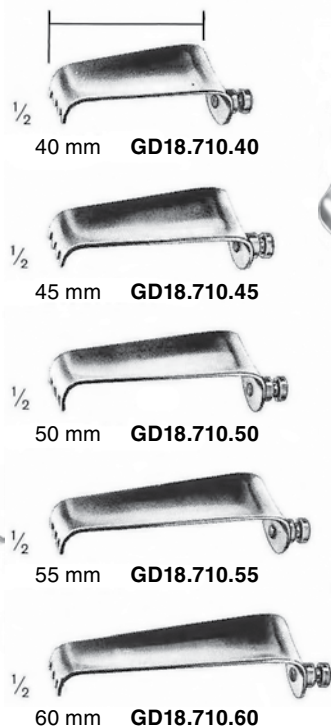

1/2 40 mm **GD18.710.40**

1/2 45 mm **GD18.710.45**

1/2 50 mm **GD18.710.50**

1/2 55 mm **GD18.710.55**

1/2 60 mm **GD18.710.60**

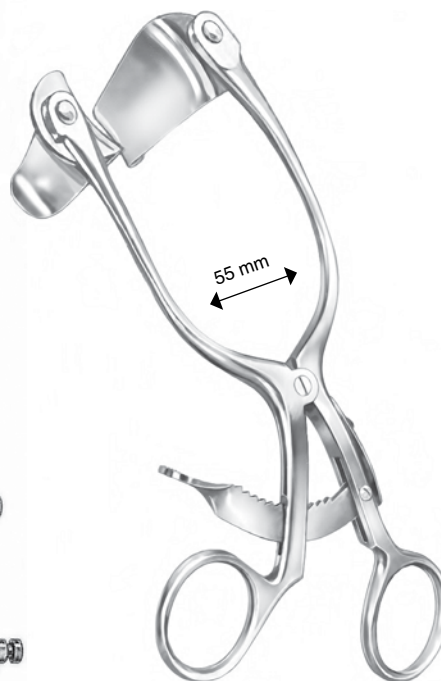

**CLOWARD**  
**GD18.711.00 - GD18.711.01**  
without blades • ohne Valvensans  
valves • sin valves • senza valve

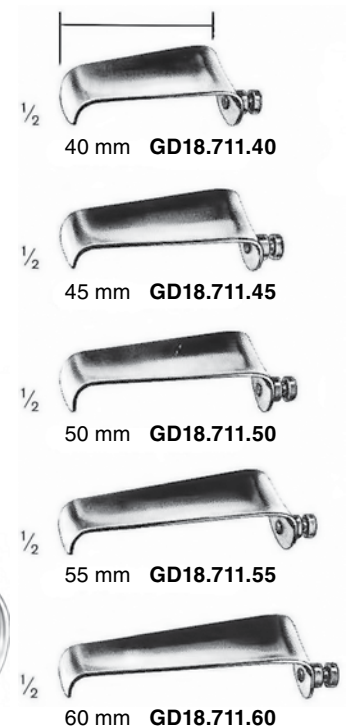

1/2 40 mm **GD18.711.40**

1/2 45 mm **GD18.711.45**

1/2 50 mm **GD18.711.50**

1/2 55 mm **GD18.711.55**

1/2 60 mm **GD18.711.60**



Retractors, vertebral Column  
Wundsperrer, ges. Wirbelsäule  
Ecarteurs, colonne vertébrale  
Separadores, columna vertebral  
Divaricatori, colonna vertebrale

**GRAND**  
DEVICES  
*The Grand Instruments Company*



**CASPAR**

**GD18.720.00** Compl.  
**GD18.720.15** • without blades • ohne Valven • sans valves  
• sin valvas • senza valve



**CASPAR**

**GD18.721.00** Compl.  
**GD18.721.15** without blades • ohne Valvensans valves  
• sin valves • senza valve



Retractors, vertebral Column  
 Wundsperrer, ges. Wirbelsäule  
 Ecarteurs, colonne vertébrale  
 Separadores, columna vertebral  
 Divaricatori, colonna vertebrale



**CASPAR**  
**GD18.724.00** Compl.  
**GD18.724.11**

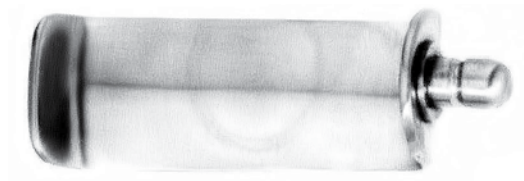

blunt  
 stumpf  
 mousse  
 roma  
 smussa

**CASPAR**

- |            |                    |
|------------|--------------------|
| 45 x 23 mm | <b>GD18.716.45</b> |
| 50 x 23 mm | <b>GD18.716.50</b> |
| 55 x 23 mm | <b>GD18.716.55</b> |
| 60 x 23 mm | <b>GD18.716.60</b> |
| 65 x 23 mm | <b>GD18.716.65</b> |



medial

**CASPAR**

- |            |                    |
|------------|--------------------|
| 40 x 23 mm | <b>GD18.718.40</b> |
| 45 x 23 mm | <b>GD18.718.45</b> |
| 50 x 23 mm | <b>GD18.718.50</b> |
| 55 x 23 mm | <b>GD18.718.55</b> |
| 60 x 23 mm | <b>GD18.718.60</b> |



lateral

**CASPAR**

- |            |                    |
|------------|--------------------|
| 40 x 23 mm | <b>GD18.719.40</b> |
| 45 x 23 mm | <b>GD18.719.45</b> |
| 50 x 23 mm | <b>GD18.719.50</b> |
| 55 x 23 mm | <b>GD18.719.55</b> |
| 60 x 23 mm | <b>GD18.719.60</b> |



Retractors, vertebral Column  
Wundsperrer, ges. Wirbelsäule  
Ecarteurs, colonne vertébrale  
Separadores, columna vertebral  
Divaricatori, colonna vertebrale

**GRAND**  
DEVICES  
*The Grand Instruments Company*



**CASPAR**

**GD18.744.00** Compl. incl. 5 blades • Valven • valves • valvas • valve

**GD18.744.17** without blades • ohne Valvensans valves • sin valves • senza valve



**GD18.747.45**  
45 mm

**GD18.747.50**  
50 mm

**GD18.747.55**  
55 mm

**GD18.747.60**  
60 mm

**GD18.747.65**  
65 mm



**CASPAR**

**GD18.747.45 - GD18.747.65**

Abdominal Retractors  
 Bauchdeckenhalter  
 Ecarteurs abdominales  
 Separadores abdominales  
 Divaricatori addominali



110 x 70 mm

80 x 45 mm

80 x 45 mm



**O'SULLIVAN-O'CONNOR**  
**GD18.754.00**

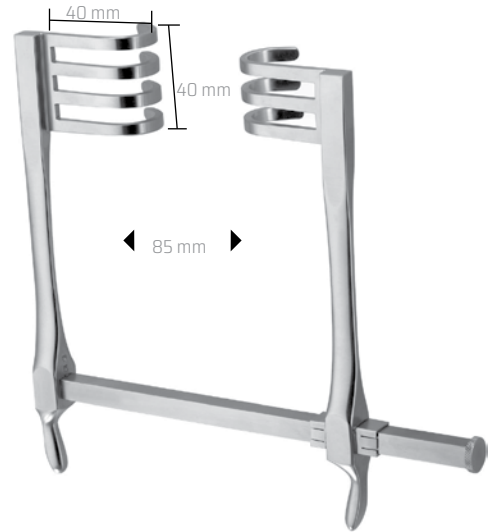

**FRAZIER**  
**GD18.758.85**

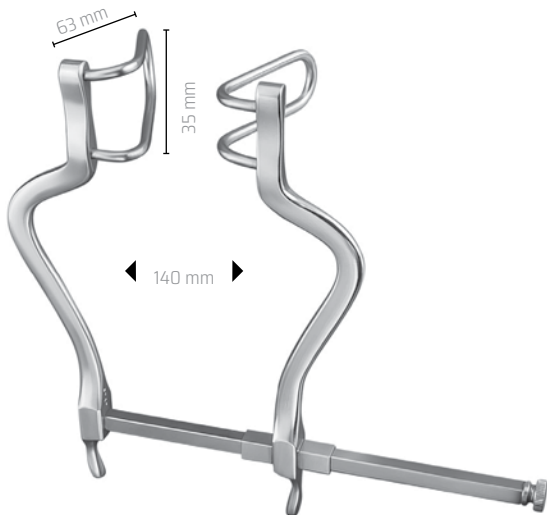

**GOSSET**  
**GD18.760.14**



**GOSSET**  
**GD18.762.16**





Abdominal Retractors  
 Bauchdeckenhalter  
 Ecarteurs abdominales  
 Separadores abdominales  
 Divaricatori addominali



**BALFOUR**  
 18.0 cm **GD18.764.18**

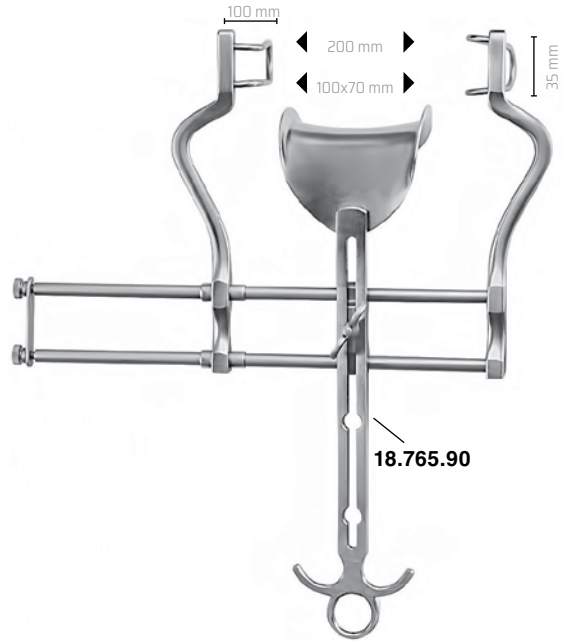

**BALFOUR**  
 20.0 cm **GD18.764.20**



**BALFOUR**  
 25.0 cm **GD18.764.25**



**BALFOUR**  
 45 x 80 mm **GD18.765.45**  
 70 x 85 mm **GD18.765.70**  
 80 x 90 mm **GD18.765.80**



**BALFOUR Baby**  
 9.0 cm **GD18.766.90**

Abdominal Retractors  
 Bauchdeckenhalter  
 Ecarteurs abdominales  
 Separadores abdominales  
 Divaricatori addominali

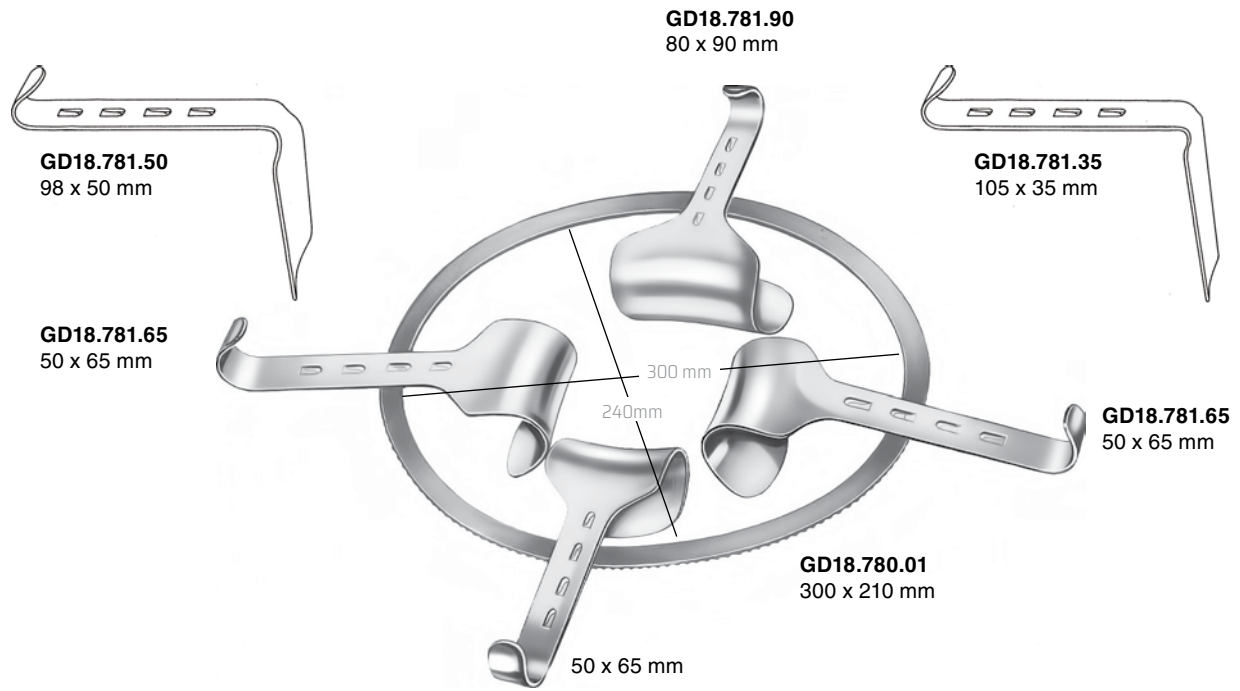

**KIRSCHNER**  
 Compl. **GD18.780.00**

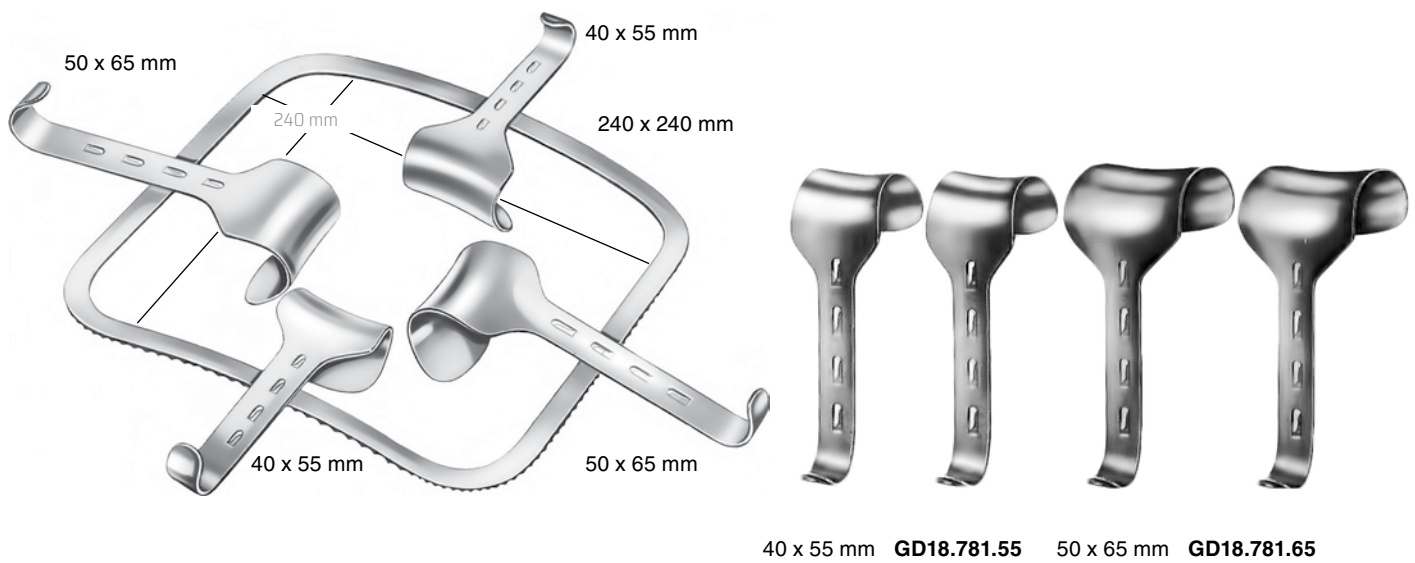

**KIRSCHNER**  
 Compl. **GD18.782.00**



Abdominal Retractors  
Bauchdeckenhalter  
Ecarteurs abdominales  
Separadores abdominales  
Divaricatori addominali

**GRAND**  
DEVICES  
The Grand Instruments Company



**GELPI**

9.0 cm **GD18.802.09**  
14.0 cm **GD18.802.14**  
16.0 cm **GD18.802.16**  
18.0 cm **GD18.802.18**



**GELPI**

18.0 cm **GD18.804.18**



**RIGBY**

18.0 cm **GD18.806.18**



**COLLIN**

**GD18.810.22**



**COLLIN**

38 x 55 mm **GD18.812.60**  
50 x 75 mm **GD18.812.80**

Abdominal Retractors  
 Bauchdeckenhalter  
 Ecarteurs abdominales  
 Separadores abdominales  
 Divaricatori addominali

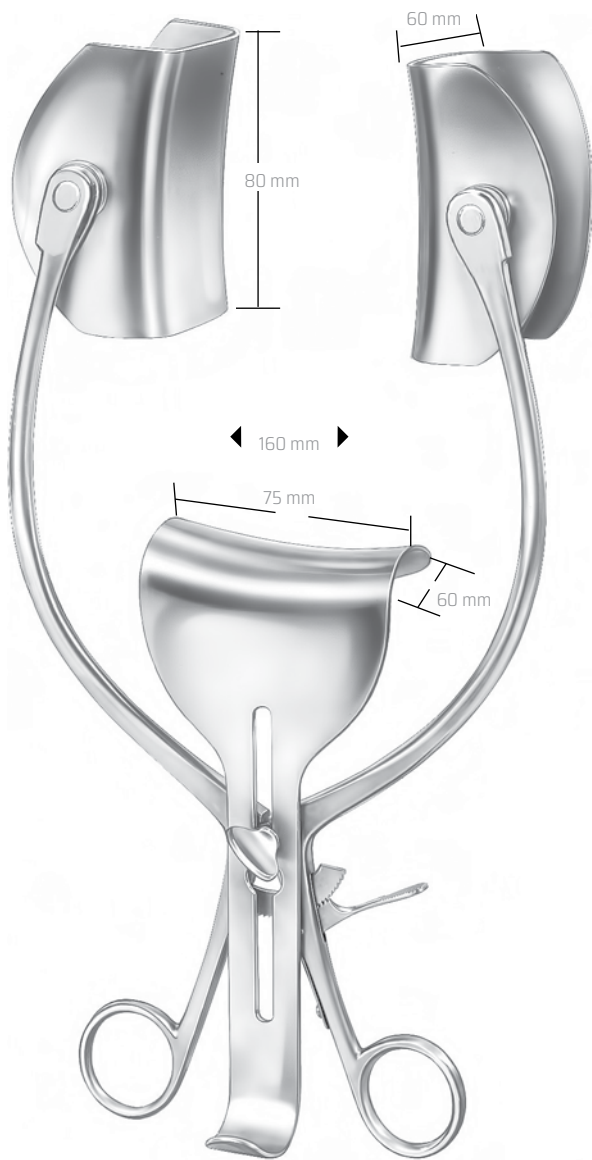

**COLLIN Lokite**  
**GD18.816.00**

Muscle Retractors (Hooks)  
 Muskelhaken  
 Ecarteurs musculaires  
 Separadores (ganchos) musculares  
 Divaricatori (unicini) muscolari



10.0 cm **GD18.902.10**



**GD18.903.00**



Bone Surgery, Osteosynthesis  
Orthopädie, Osteosynthese  
Chirurgie osseuse, Ostéosynthèse  
Cirugía òsea, Osteosíntesis  
Chirurgia ossea, Osteosintesi  
骨外科·骨合成

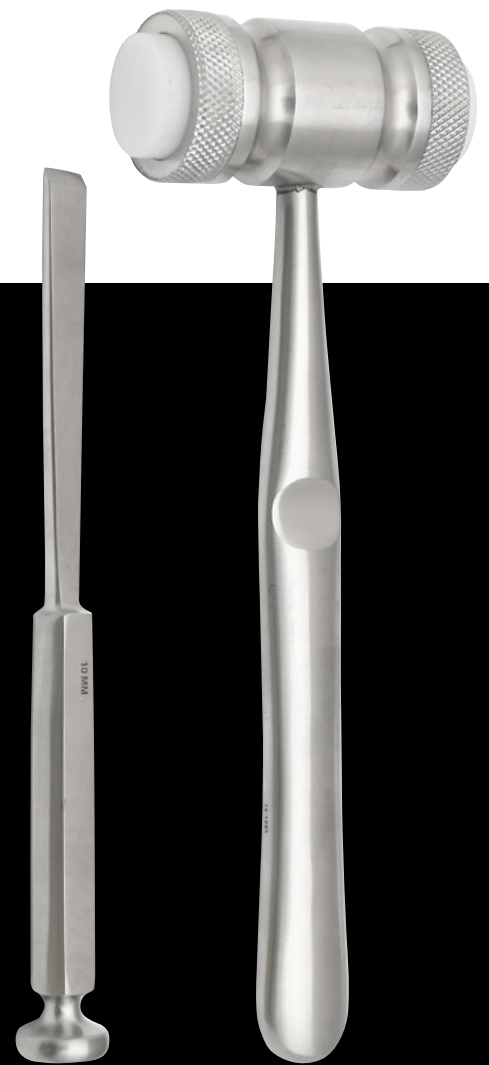

**GD19**



Bone Rongeurs  
Hohlmeißelzangen  
Pincés-gouges  
Pinzas-gubias  
Pinze sgorbie

**GRAND**  
DEVICES  
The Grand Instruments Company



**FRIEDMAN Mini**  
12.0 cm **GD19.101.12**



**FRIEDMAN**  
14.0 cm **GD19.101.14**



**FRIEDMAN**  
15.0 cm **GD19.102.15**



**CLEVELAND**  
14.0 cm **GD19.103.14**

**FRIEDMAN**  
14.0 cm **GD19.102.14**

Fig. 4

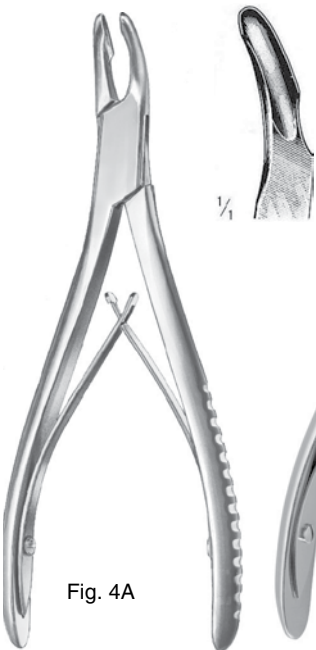

**CLEVELAND**  
17.0 cm **GD19.105.17**

Fig. 4A

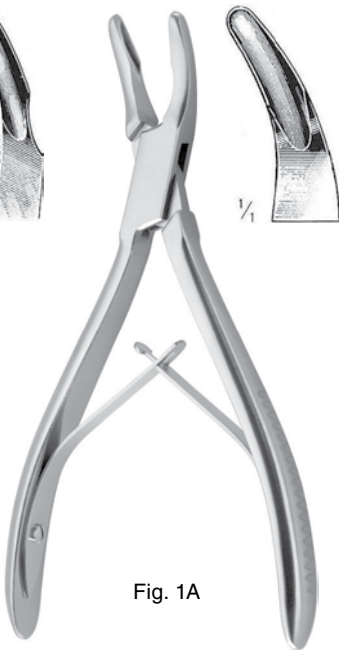

**MEAD**  
16.0 cm **GD19.107.16**

Fig. 1A

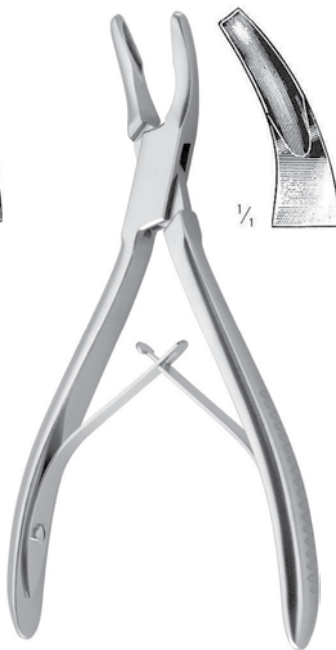

**MEAD**  
16.5 cm **GD19.109.16**



**BLUMENTHAL**  
15.5 cm **GD19.115.15**



**BLUMENTHAL**  
15.5 cm **GD19.117.15**



**BLUMENTHAL**  
15.5 cm **GD19.119.15**



Bone Rongeurs  
Hohlmeißelzangen  
Pincas-gouges  
Pinzas-gubias  
Pinze sgorbie



**LUER**  
15.0 cm **GD19.131.15**



**LUER**  
15.0 cm **GD19.133.15**

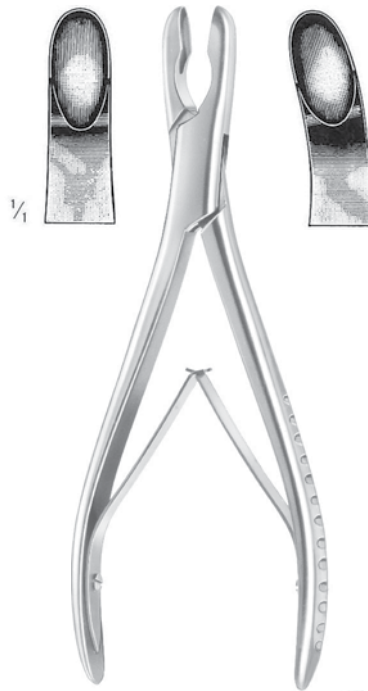

**LUER**  
17.0 cm **GD19.136.17**



**ADSON**  
20.0 cm **GD19.142.20**



**OLIVECRONA**  
20.0 cm **GD19.147.20**



**LEMPERT**  
16.0 cm **GD19.150.16**

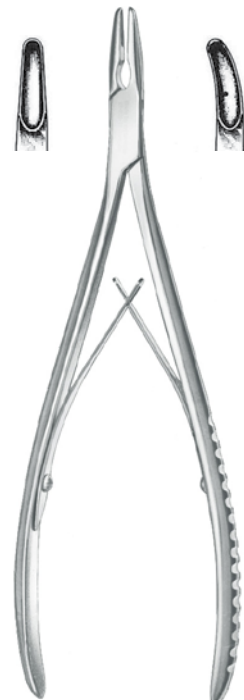

**LEMPERT**  
18.5 cm **GD19.154.18**





Bone Rongeurs  
Hohlmeißelzangen  
Pincés-gouges  
Pinzas-gubias  
Pinze sgorbie

**GRAND**  
DEVICES  
The Grand Instruments Company



**BEYER**

18.0 cm **GD19.201.18**



**ZUFAL-JANSEN**

18.0 cm **GD19.205.18**



**BÖHLER**

**GD19.210.15** 15 cm/2mm **GD19.211.15**  
**GD19.212.15** 15 cm/3mm **GD19.213.15**



**RUSKIN**

**GD19.216.18** 18.0 cm **GD19.217.18**



**RUSKIN**

**GD19.218.23** 23.0 cm **GD19.219.23**



**STILLE-LUER**

**GD19.230.22** 22.0 cm **GD19.231.22**  
**GD19.230.26** 26.0 cm **GD19.231.26**



**STILLE-LUER**

23.0 cm **GD19.235.23**



**STILLE-RUSKIN**  
23.0 cm **GD19.237.23**

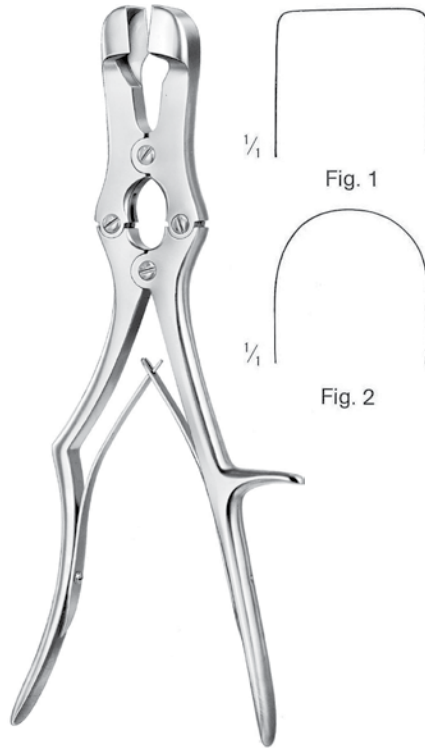

**SAUERBRUCH**  
Fig. 1 30.0 cm **GD19.241.30**  
Fig. 2 30.0 cm **GD19.243.30**

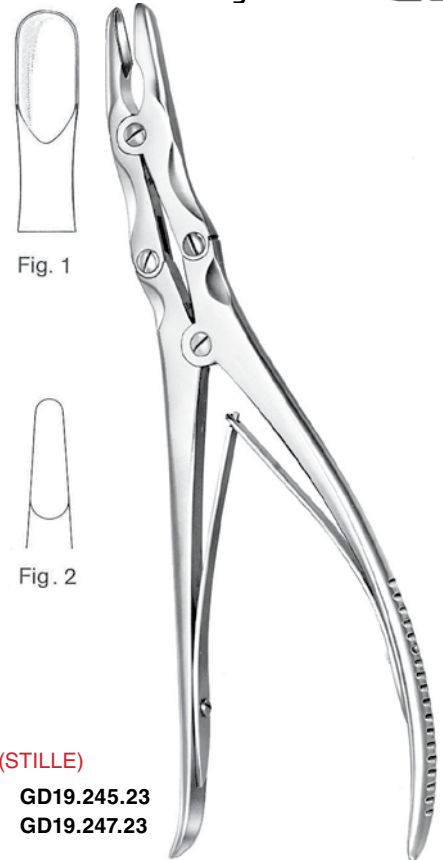

**LEKSELL (STILLE)**  
Fig. 1 8.0 mm **GD19.245.23**  
Fig. 2 4.0 mm **GD19.247.23**  
23 cm



**R SCAGLIETTI L**  
**GD19.251.26** 26.0 cm **GD19.253.26**  
à droite à gauche  
derecha izquierda  
a destra a sinistra



**FRYKHOLM**  
24.0 cm **GD19.255.24**



**ECHLIN**  
2.0 mm **GD19.259.02**  
3.0 mm **GD19.259.03**  
4.0 mm **GD19.259.23**  
23.0 cm



Bone Cutting Forceps  
 Knochensplitterzangen  
 Pinces coupantes à os  
 Pinzas cortantes para huesos  
 Cesoie per ossa

**GRAND**  
 DEVICES  
 The Grand Instruments Company

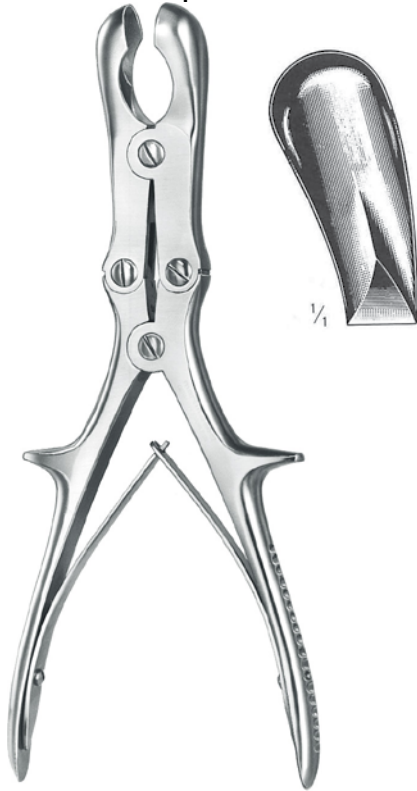

**SEMB**

22.5 cm **GD19.261.22**  
 27.0 cm **GD19.261.27**



**LISTON**

<b>GD19.274.14</b>	14.0 cm	<b>GD19.275.14</b>
<b>GD19.274.17</b>	17.0 cm	<b>GD19.275.17</b>
<b>GD19.274.19</b>	19.0 cm	<b>GD19.275.19</b>
<b>GD19.274.22</b>	22.0 cm	<b>GD19.275.22</b>



**BÖHLER**

**GD19.280.15** 15.0 cm **GD19.281.15**

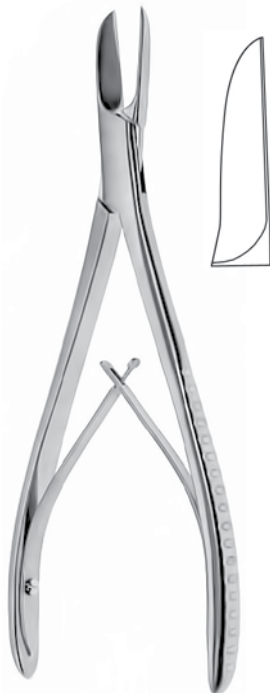

**COTTLE-KAZANJIAN**

19.0 cm **GD19.282.19**



**RUSKIN-LISTON**

**GD19.286.18** 18.5 cm **GD19.289.18**



**STILLE-LISTON**

**GD19.290.27** 27.0 cm **GD19.291.27**

Bone Cutting Forceps  
 Knochensplitterzangen  
 Pinces coupantes à os  
 Pinzas cortantes para huesos  
 Cesioie per ossa

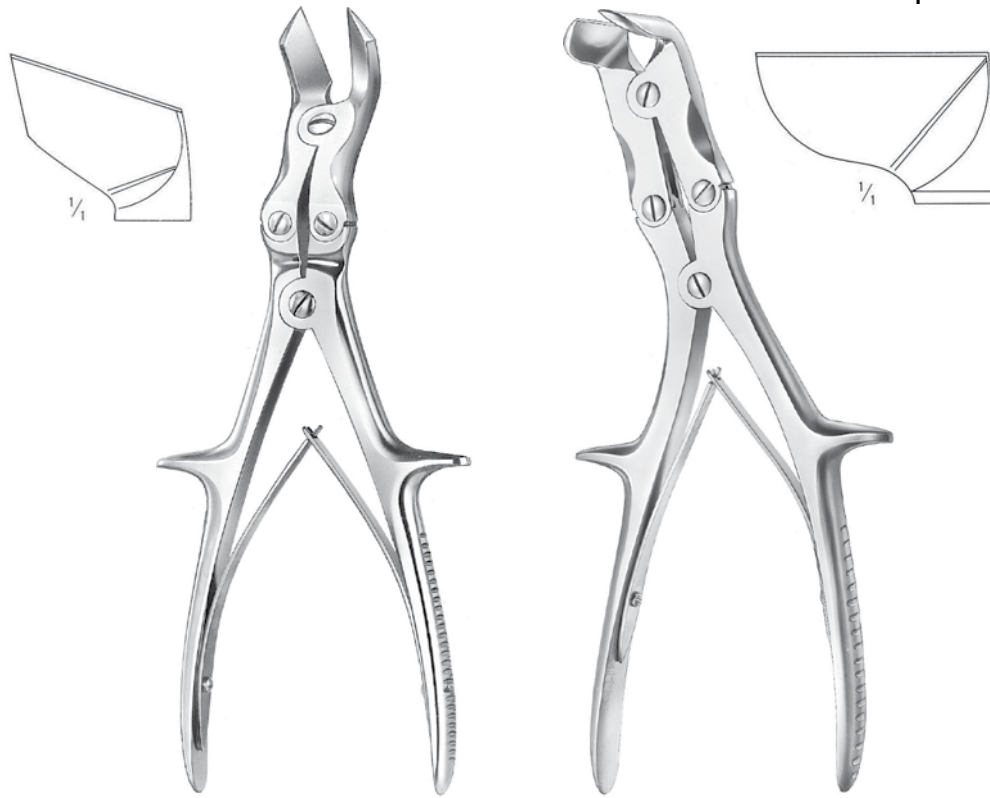

**STILLE-HORSLEY**

27.0 cm **GD19.293.27**

**SEMB**

24.0 cm **GD19.295.24**

Bone Holding Forceps  
 Knochenhalte-zangen  
 Daviers porte-os  
 Pinzas para huesos  
 Tenaglie per ossa



**FERGUSSON**

21.0 cm **GD19.360.21**

**LANGENBECK**

21.0 cm **GD19.362.21**

**SEMB**

19.0 cm **GD19.365.19**

**FARABEUF**

23.0 cm **GD19.366.23**  
 26.0 cm **GD19.366.26**





Bone Holding Forceps  
Knochenhaltezaugen  
Daviers porte os  
Pinzas para huesos  
Tenaglie per ossa

**GRAND**  
DEVICES  
The Grand Instruments Company



**FARABEU-F-LAMBOTTE**  
26.0 cm **GD19.368.26**



**LAMBOTTE**  
22.0 cm **GD19.370.22**  
27.0 cm **GD19.370.27**  
30.0 cm **GD19.370.30**



**LAMBOTTE**  
22.0 cm **GD19.372.22**  
26.0 cm **GD19.372.26**  
33.0 cm **GD19.372.33**



**LAMBOTTE**  
19.0 cm **GD19.373.19**  
23.0 cm **GD19.373.23**  
26.0 cm **GD19.373.26**



**KERN**  
15.0 cm **GD19.378.15**  
17.0 cm **GD19.378.17**  
21.0 cm **GD19.378.21**

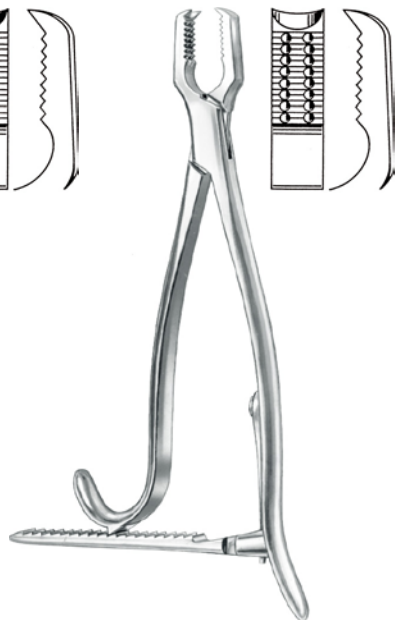

**GD19.380.15**  
**GD19.380.17**  
**GD19.380.21**

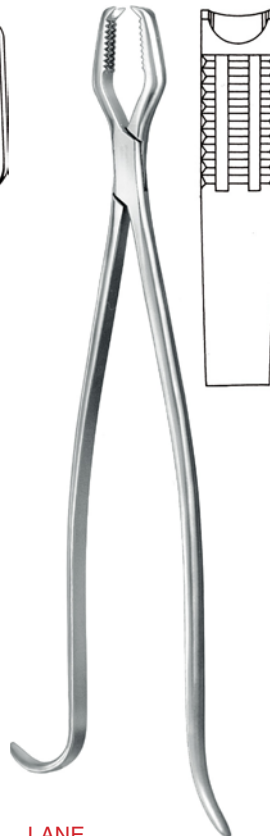

**LANE**  
33.0 cm **GD19.382.33**  
45.0 cm **GD19.382.45**

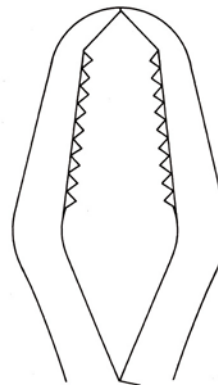

**LANE**  
33.0 cm **GD19.384.33**  
45.0 cm **GD19.384.45**

Bone Holding Forceps  
 Knochenhaltezangen  
 Daviers porte os  
 Pinzas para huesos  
 Tenaglie per ossa



Self-centering  
 Selbstzentrierend  
 autocentrant  
 autocentrantes  
 autocentranti



**GD19.391.15 - GD19.391.28**



**GD19.391.15**  
 15.0 cm

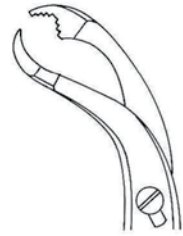

**GD19.391.19**  
 19.0 cm

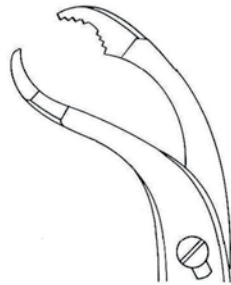

**GD19.391.24**  
 24.0 cm

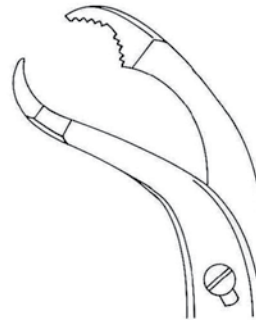

**GD19.391.26**  
 26.0 cm

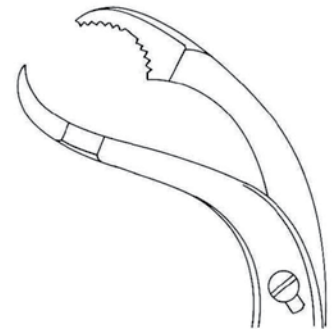

**GD19.391.28**  
 28.0 cm



**VERBRUGGE**  
**GD19.395.17 - GD19.395.27**



**GD19.395.17**  
 17.5 cm



**GD19.395.25**  
 25.0 cm



**GD19.395.26**  
 26.0 cm



**GD19.395.27**  
 27.0 cm



Bone Holding, Sequester Forceps  
 Knochenhalte-, Sequesterzangen  
 Pinces à os, à séquestres  
 Pinzas para huesos y secuestros  
 Pinze per ossa e sequestri

**GRAND**  
 DEVICES  
 The Grand Instruments Company



**LEWIN**

17.5 cm **GD19.402.17**

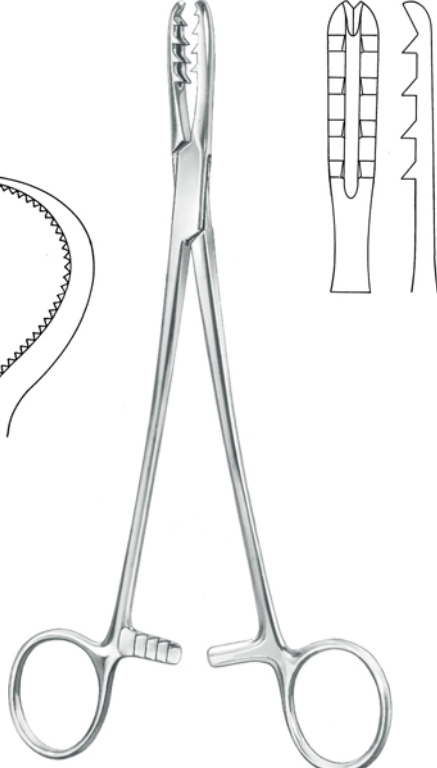

**BIRCHER-GANSKE**

**GD19.404.20** 20.0 cm **GD19.405.20**

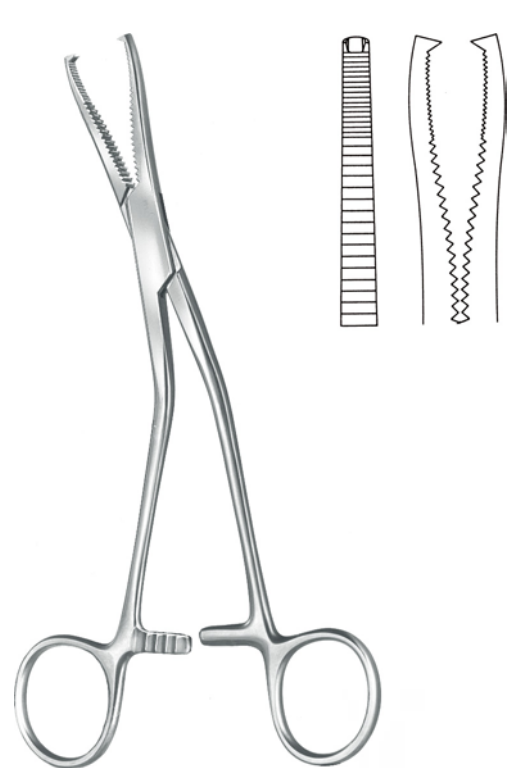

**DINGMANN**

19.0 cm **GD19.407.19**



13.5 cm **GD19.409.13**

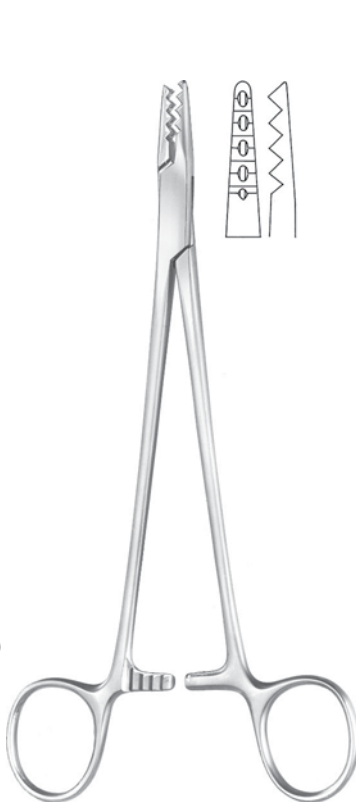

**MARTIN**

19.0 cm **GD19.410.19**

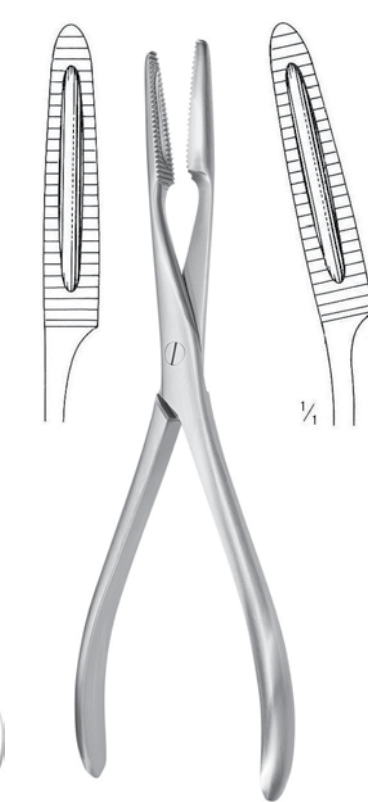

**GD19.420.20** 20.0 cm **GD19.421.20**



**VAN BUREN**

23.0 cm **GD19.423.23**



**LOWMAN**

13.0 cm **GD19.441.13**  
18.5 cm **GD19.441.18**  
20.0 cm **GD19.441.20**



**GERSTER**

**GD19.444.15**

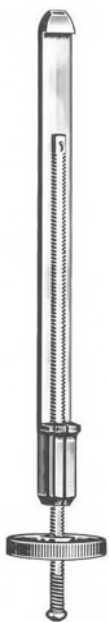
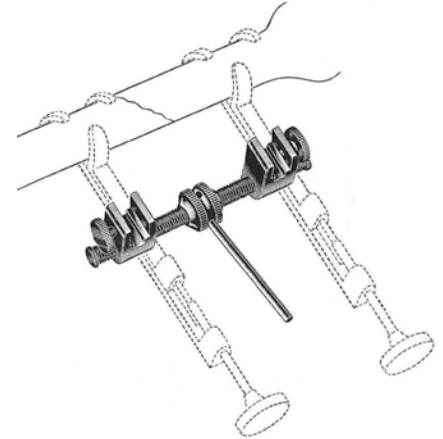

**PARHAM**

**GD19.446.24**



**PARHAM**

18.0 cm **GD19.448.18**  
30.0 cm **GD19.448.30**



**GD19.450.01** Adult size  
f. Erwachsene  
p. adultes  
p. adultos  
p. adulti

**GD19.450.02** Child size  
f. Kinder  
p. enfants  
p. niños  
p. bambini





Bone Curettes  
Scharfe Löffel  
Curettes à os  
Cucharillas cortantes  
Curette taglianti

**GRAND**  
DEVICES  
The Grand Instruments Company

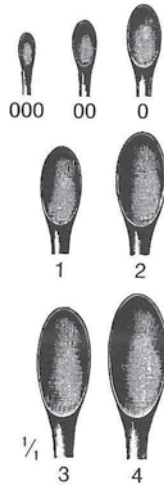

**SCHEDE**

GD19.467.97  
GD19.467.98  
GD19.468.00  
GD19.468.01  
GD19.468.02  
GD19.468.03  
GD19.468.04

**Fig.**

0000  
000  
00  
0  
1  
2  
3  
4  
5  
6

**VOLKMANN**

GD19.469.96  
GD19.469.97  
GD19.469.98  
GD19.470.00  
GD19.470.01  
GD19.470.02  
GD19.470.03  
GD19.470.04  
GD19.470.05  
GD19.470.06

**SCHEDE**

GD19.467.97 - GD19.468.04

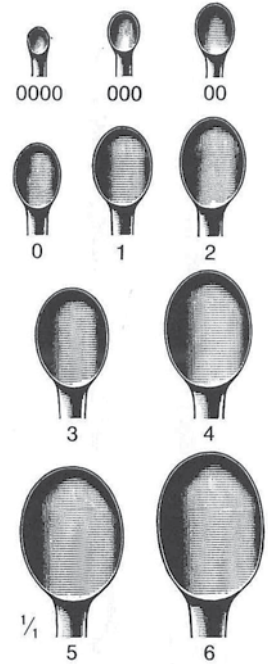

**VOLKMANN**

GD19.469.96 - GD19.470.06

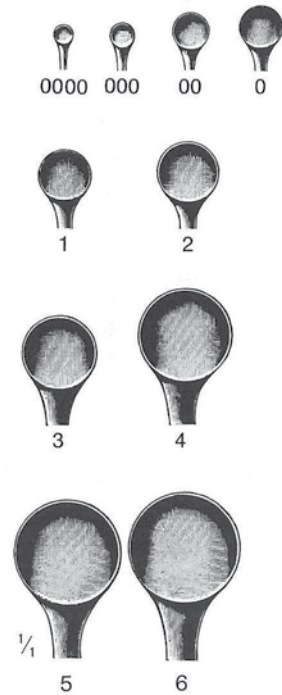

**BRUNS**

GD19.471.96  
GD19.471.97  
GD19.471.98  
GD19.472.00  
GD19.472.01  
GD19.472.02  
GD19.472.03  
GD19.472.04  
GD19.472.05  
GD19.472.06

**Fig.**

0000  
000  
00  
0  
1  
2  
3  
4  
5  
6

**SPRATT**

GD19.474.96  
GD19.474.97  
GD19.474.98  
GD19.475.00  
GD19.475.01  
GD19.475.02  
GD19.475.03  
GD19.475.04  
GD19.475.05

**BRUNS**

GD19.471.96 - GD19.472.06

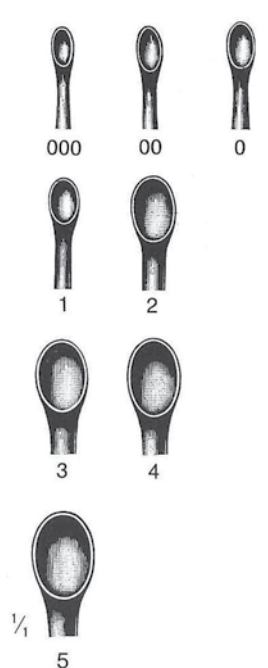

**SPRATT**

GD19.474.97 - GD19.475.05

Bone Curettes  
Scharfe Löffel  
Curettes à os  
Cucharillas cortantes  
Curette taglianti

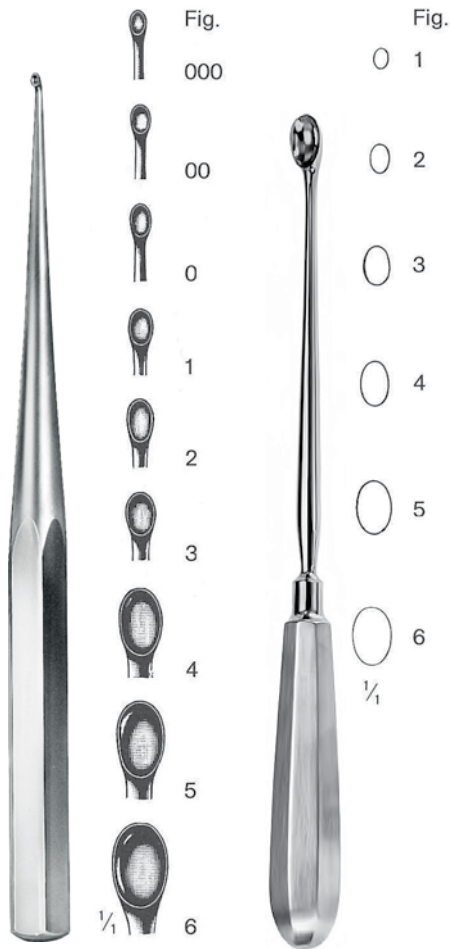

**BRUNS**  
GD19.480.97 000  
GD19.480.98 00  
GD19.481.00 0  
GD19.481.01 1  
GD19.481.02 2  
GD19.481.03 3  
GD19.481.04 4  
GD19.481.05 5  
GD19.481.06 6  
23.0 cm

**SIMON**  
GD19.485.01  
GD19.485.02  
GD19.485.03  
GD19.485.04  
GD19.485.05  
GD19.485.06  
24.0 cm

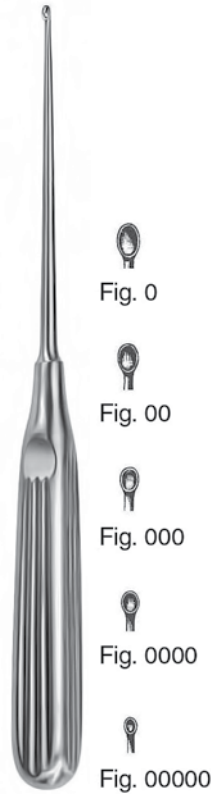

**LEMPERT**  
GD19.490.10  
GD19.490.20  
GD19.490.30  
GD19.490.40  
GD19.490.50  
21.5 cm



**HALLE**  
1 GD19.491.01  
2 GD19.491.02  
3 GD19.491.03  
21.0 cm

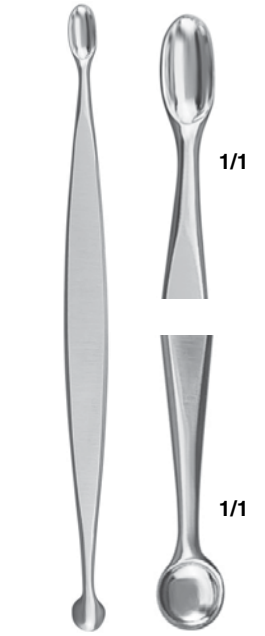

**VOLKMANN**  
13.0 cm GD19.492.13  
16.0 cm GD19.492.16  
20.0 cm GD19.492.20



**VOLKMANN**  
13.0 cm GD19.494.13  
14.0 cm GD19.494.14  
17.0 cm GD19.494.17

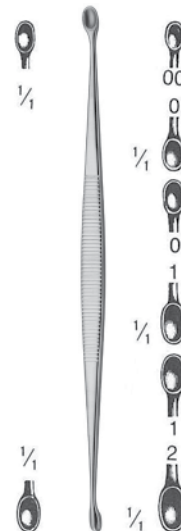

**WILLIGER**  
GD19.496.00 00/0  
GD19.496.01 0/1  
GD19.496.12 1/2  
13.5 cm



**MARTINI**  
GD19.498.00  
GD19.498.01  
GD19.498.12  
13.5 cm



Bone Chisels and Gouges  
 Knochenmeißel  
 Ciseaux-burins, gouges  
 Cinceles, gubias  
 Scalpelli, sgorbie



04 mm	<b>GD19.602.04</b>	<b>GD19.604.04</b>	<b>GD19.605.04</b>
06 mm		<b>GD19.604.06</b>	
08 mm	<b>GD19.602.08</b>	<b>GD19.604.08</b>	<b>GD19.605.08</b>
10 mm	<b>GD19.602.10</b>	<b>GD19.604.10</b>	<b>GD19.605.10</b>
12 mm	<b>GD19.602.12</b>	<b>GD19.604.12</b>	<b>GD19.605.12</b>
14 mm	<b>GD19.602.14</b>	<b>GD19.604.14</b>	<b>GD19.605.14</b>
16 mm	<b>GD19.602.16</b>	<b>GD19.604.16</b>	<b>GD19.605.16</b>
	13.5 cm	13.5 cm	13.5 cm



ALEXANDER

04 mm	<b>GD19.610.04</b>	<b>GD19.611.04</b>
06 mm	<b>GD19.610.06</b>	<b>GD19.611.06</b>
08 mm	<b>GD19.610.08</b>	<b>GD19.611.08</b>
10 mm	<b>GD19.610.10</b>	<b>GD19.611.10</b>
12 mm	<b>GD19.610.12</b>	<b>GD19.611.12</b>
14 mm	<b>GD19.610.14</b>	<b>GD19.611.14</b>
	17.0 cm	17.0 cm

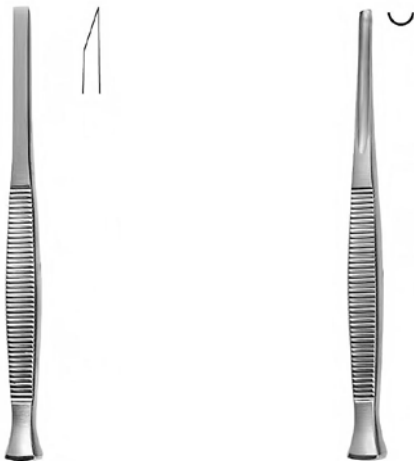

PARTSCH

2 mm	<b>GD19.620.02</b>	<b>GD19.622.02</b>
3 mm	<b>GD19.620.03</b>	<b>GD19.622.03</b>
4 mm	<b>GD19.620.04</b>	<b>GD19.622.04</b>
5 mm	<b>GD19.620.05</b>	<b>GD19.622.05</b>
6 mm	<b>GD19.620.06</b>	<b>GD19.622.06</b>
7 mm	<b>GD19.620.07</b>	<b>GD19.622.07</b>
8 mm	<b>GD19.620.08</b>	<b>GD19.622.08</b>
	13.5 cm	17.0 cm

PARTSCH

10 mm	<b>GD19.623.02</b>	<b>GD19.625.02</b>
15 mm	<b>GD19.623.03</b>	<b>GD19.625.03</b>
20 mm	<b>GD19.623.04</b>	<b>GD19.625.04</b>
25 mm	<b>GD19.623.05</b>	<b>GD19.625.05</b>
	<b>GD19.623.06</b>	<b>GD19.625.06</b>
	<b>GD19.623.07</b>	<b>GD19.625.07</b>
	<b>GD19.623.08</b>	<b>GD19.625.08</b>
	13.5 cm	17.0 cm



STILLE

10 mm	<b>GD19.630.10</b>	<b>GD19.632.10</b>	<b>GD19.633.10</b>
15 mm	<b>GD19.630.15</b>	<b>GD19.632.15</b>	<b>GD19.633.15</b>
20 mm	<b>GD19.630.20</b>	<b>GD19.632.20</b>	<b>GD19.633.20</b>
25 mm	<b>GD19.630.25</b>	<b>GD19.632.25</b>	<b>GD19.633.25</b>
	20.0 cm	20.0 cm	20.0 cm

Bone Chisels and Gouges  
 Knochenmeißel  
 Ciseaux-burins, gouges  
 Cinceles, gubias  
 Scalpelli, sgorbie

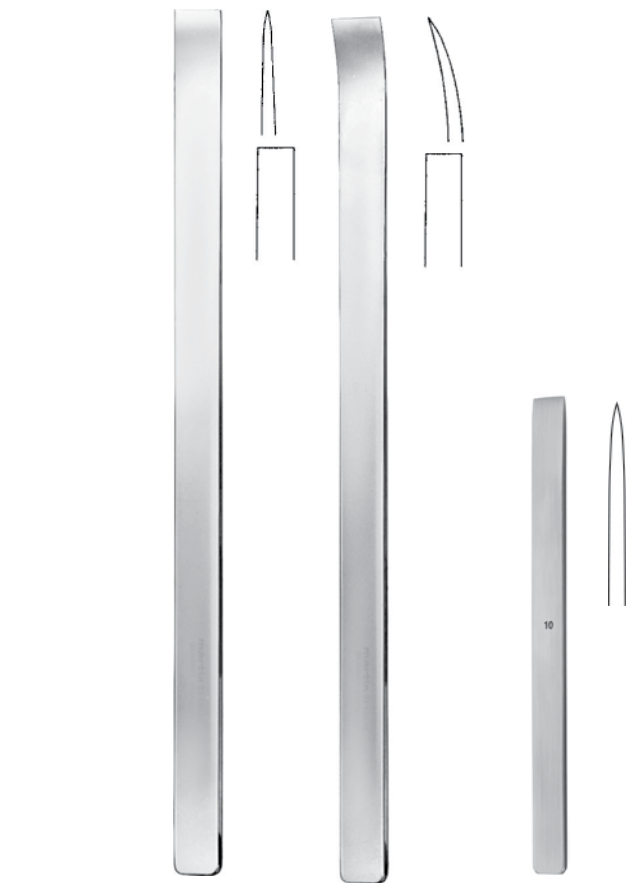

**SMITH-PETERSEN**

6 mm	<b>GD19.634.06</b>	<b>GD19.635.06</b>	<b>GD19.637.06</b>	<b>GD19.639.06</b>
9 mm	<b>GD19.634.09</b>	<b>GD19.635.09</b>	<b>GD19.637.09</b>	<b>GD19.639.09</b>
13 mm	<b>GD19.634.13</b>	<b>GD19.635.13</b>	<b>GD19.637.13</b>	<b>GD19.639.13</b>
16 mm	<b>GD19.634.16</b>	<b>GD19.635.16</b>	<b>GD19.637.16</b>	<b>GD19.639.16</b>
19 mm	<b>GD19.634.19</b>	<b>GD19.635.19</b>	<b>GD19.637.19</b>	<b>GD19.639.19</b>
25 mm	<b>GD19.634.25</b>	<b>GD19.635.25</b>	<b>GD19.637.25</b>	<b>GD19.639.25</b>
32 mm	<b>GD19.634.32</b>	<b>GD19.635.32</b>	<b>GD19.637.32</b>	<b>GD19.639.32</b>
	20.0 cm	20.0 cm	20.0 cm	20.0 cm

**LAMBOTTE**

6.50 mm	<b>GD19.650.06</b>	<b>GD19.651.06</b>	3 mm	<b>GD19.654.03</b>
15.0 mm	<b>GD19.650.15</b>	<b>GD19.651.15</b>	4 mm	<b>GD19.654.04</b>
20.0 mm	<b>GD19.650.20</b>	<b>GD19.651.20</b>	6 mm	<b>GD19.654.06</b>
25.0 mm	<b>GD19.650.25</b>	<b>GD19.651.25</b>	8 mm	<b>GD19.654.08</b>
30.0 mm	<b>GD19.650.30</b>	<b>GD19.651.30</b>	10 mm	<b>GD19.654.10</b>
38.0 mm	<b>GD19.650.38</b>	<b>GD19.651.38</b>	12 mm	<b>GD19.654.12</b>
44.0 mm	<b>GD19.650.44</b>	<b>GD19.651.44</b>	15 mm	<b>GD19.654.15</b>
	24.0 cm	23.0 cm		12.5 cm

**LAMBOTTE Mini**



Bone Chisels and Gouges  
 Knochenmeißel  
 Ciseaux-burins, gouges  
 Cinceles, gubias  
 Scalpelli, sgorbie



LEXER

- 7 mm **GD19.660.07**
- 10 mm **GD19.660.10**
- 15 mm **GD19.660.15**
- 20 mm **GD19.660.20**
- 25 mm **GD19.660.25**
- 30 mm **GD19.660.30**
- 22.0 cm



LEXER

- GD19.661.07**
- GD19.661.10**
- GD19.661.15**
- GD19.661.20**
- GD19.661.25**
- GD19.661.30**
- 22.0 cm



LEXER Mini

- 4 mm **GD19.664.04**
- 6 mm **GD19.664.06**
- 8 mm **GD19.664.08**
- 10 mm **GD19.664.10**
- 12 mm **GD19.664.12**



LEXER Mini

- GD19.665.04**
- GD19.665.06**
- GD19.665.08**
- GD19.665.10**
- GD19.665.12**



HOKE

- 3 mm **GD19.668.03**
- 5 mm **GD19.668.05**
- 6 mm **GD19.668.06**
- 8 mm **GD19.668.08**
- 9 mm **GD19.668.09**
- 17.0 cm



- 6 mm **GD19.670.06**
- 13 mm **GD19.670.13**
- 19 mm **GD19.670.19**
- 25 mm **GD19.670.25**
- 32 mm **GD19.670.32**
- 24.0 cm



- GD19.672.06**
- GD19.672.13**
- GD19.672.19**
- GD19.672.25**
- GD19.672.32**
- 24.0 cm



HIBBS

- GD19.671.06**
- GD19.671.13**
- GD19.671.19**
- GD19.671.25**
- GD19.671.32**
- 24.0 cm



- GD19.673.06**
- GD19.673.13**
- GD19.673.19**
- GD19.673.25**
- GD19.673.32**
- 24.0 cm



- GD19.675.06**
- GD19.675.13**
- GD19.675.19**
- GD19.675.25**
- GD19.675.32**
- 24.0 cm

Bone Chisels and Gouges  
 Knochenmeißel  
 Ciseaux-burins, gouges  
 Cinceles, gubias  
 Scalpelli, sgorbie



LEBSCHKE

24.5 cm **GD19.678.24**



**GD19.679.22**  
 22.0 cm



VIRCHOW

**GD19.680.12**



BURNETTI

28.0 cm **GD19.681.28** **GD19.683.28**

Post Mortem Set  
 Autopsie-Besteck  
 Set à autopsie  
 Juego de autopsia  
 Set per autopsia



**GD19.684.00**





Bone Hammers and Mallets  
 Hämmer  
 Maillets  
 Martillos y mazos  
 Martelli

**GRAND**  
 DEVICES  
*The Grand Instruments Company*



**GERZOG**  
**GD19.686.25**  
 18.0 cm 250 gm



**KIRK**  
**GD19.688.75**  
 19.0 cm 750 gm



450 gm **GD19.690.45**  
 900 gm **GD19.690.90**  
 19.0 cm



**COLLIN**  
**GD19.692.22**  
 20.0 cm 220 gm



**WILLIGER**  
**GD19.694.34**  
 24.0 cm 340 gm

**GD19.697.02**

Pair of Spare Faces  
 Paar Ersatzbacken  
 Paire de faces de rechange  
 Pareja de tapas intercambiables  
 Coppia di teste di ricambio



**LUCAE**  
**GD19.696.26**  
 19.0 cm 260 gm



**MEAD**  
**GD19.696.32**  
 17.0 cm 320 gm



250 gm **GD19.698.25**  
 400 gm **GD19.698.40**  
 26.0 cm



**QUISLING**  
**GD19.698.75**



**GD19.699.00**  
 23.5 cm

Periosteal Elevators  
 Raspatorien  
 Rugines-raspatoires  
 Periostótomos  
 Periostotomi



**FARABEU**  
 15.0 cm **GD19.702.15**



**FARABEU**  
 15.0 cm **GD19.703.15**



**LAMBOTTE**  
 10 mm **GD19.705.10**  
 15 mm **GD19.705.15**  
 20 mm **GD19.705.20**  
 25 mm **GD19.705.25**  
 15.0 cm



**SEDILLOT**  
 21.0 cm **GD19.709.21**

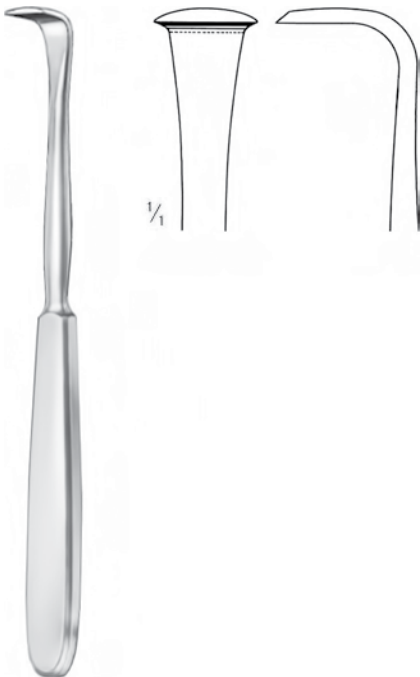

**LANGENBECK**  
 18.0 cm **GD19.711.18**



**WILLIGER**  
 16.0 cm **GD19.713.16**

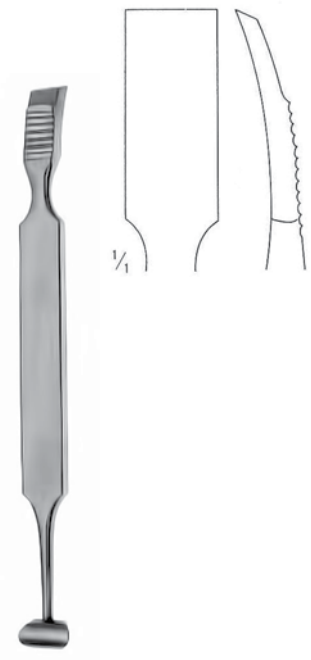

**ALEXANDER**  
 16.0 cm **GD19.715.16**  
 20.0 cm **GD19.715.20**





Periosteal Elevators  
 Raspatorien  
 Rugines-raspatoires  
 Periostótomos  
 Periostotomi



Rib  
 Für Rippen  
 Pour les côtes  
 Para costillas  
 Costali



**DOYEN**

GD19.721.17 17.0 cm    GD19.723.17  
 GD19.725.17 17.0 cm    GD19.727.17



GD19.729.01  
 1/2 17.5 cm



GD19.729.02  
 21.0 cm



GD19.729.03  
 17.5 cm



GD19.729.04  
 21.0 cm



GD19.729.05  
 20.5 cm



GD19.729.06  
 20.5 cm



GD19.729.07  
 225 cm

**SEMB**

GD19.729.01 - GD19.729.07



**MATSON**

22.0 cm **GD19.733.22**



**OVERHOLT**

29.5 cm **GD19.735.29**



**OVERHOLT**

29.5 cm **GD19.737.29**



**OVERHOLT**

28.5 cm **GD19.739.28**



**LANGENBECK**

20.0 cm **GD19.751.20**



**LANGENBECK**

20.0 cm **GD19.753.20**



**ADSON**

**GD19.754.17 - GD19.757.17**  
17.0 cm

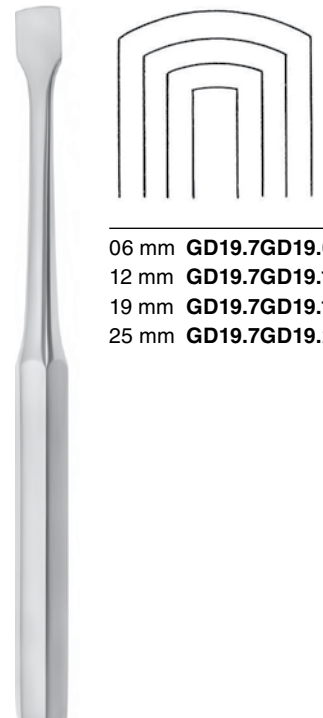

**KEY**

**GD19.7GD19.06 - GD19.7GD19.25**  
19.0 cm

06 mm **GD19.7GD19.06**  
12 mm **GD19.7GD19.12**  
19 mm **GD19.7GD19.19**  
25 mm **GD19.7GD19.25**



Elevators, Bone Levers  
Elevatorien, Knochenhebel  
Elévateurs, Leviers à os  
Elevadores, E, para huesos  
Elevatori, Elevatori per ossa

**GRAND**  
DEVICES  
The Grand Instruments Company



**WATSON-CHEYNE**  
17.5 cm **GD19.765.17**



**McDONALD**  
19.0 cm **GD19.767.19**



**MURPHY-LANE**  
30.0 cm **GD19.769.30**

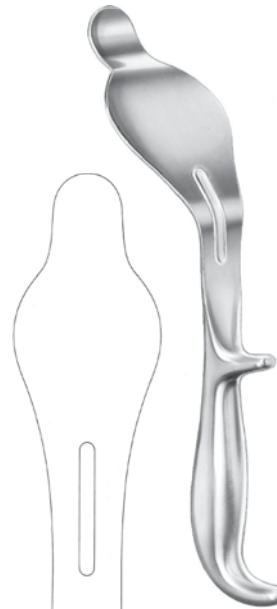

**BENNETT**  
65 x 260 mm **GD19.771.71**

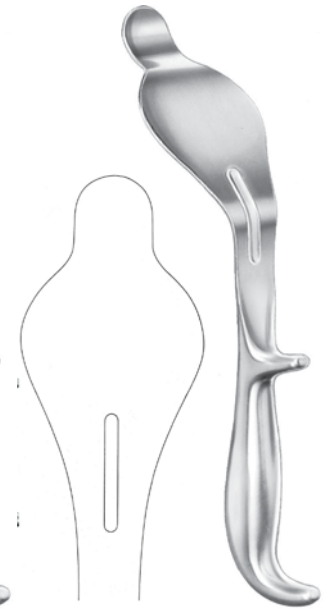

**BENNETT**  
45 x 260 mm **GD19.771.73**



**HOHMANN**  
8 mm **GD19.801.08**



**HOHMANN**  
18 mm **GD19.801.18**

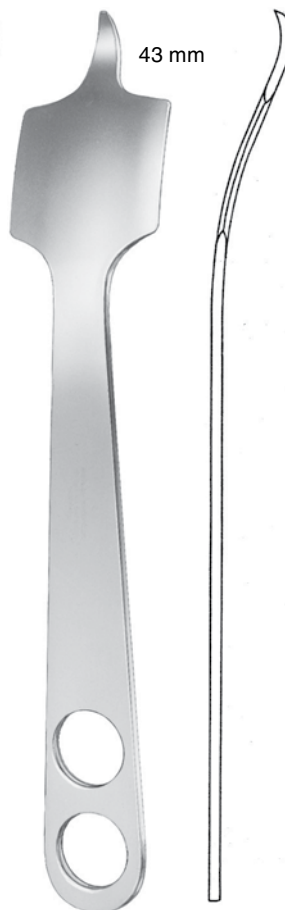

**HOHMANN**  
43 mm **GD19.801.43**



**HOHMANN**  
70 mm **GD19.801.70**

Bone Levers  
Knochenhebel  
Leviers à os Elevadores  
para huesos Elevatori  
per ossa

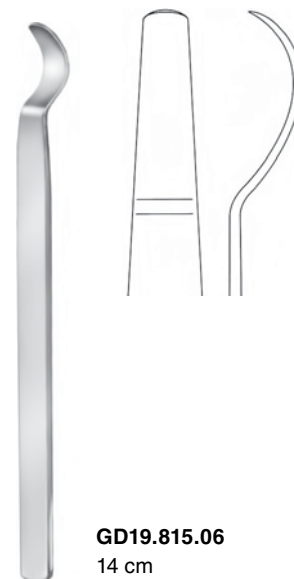
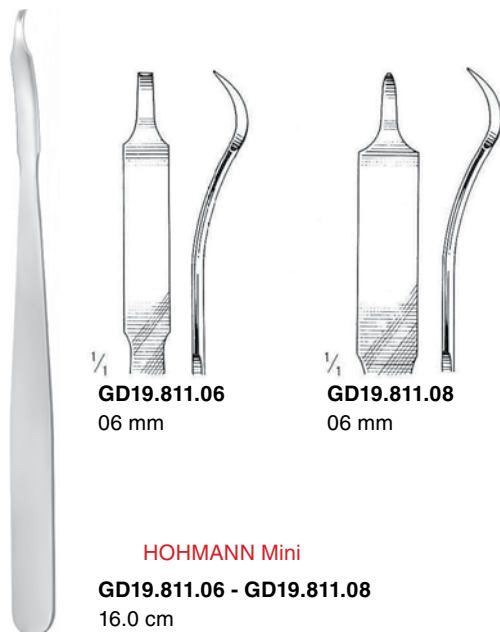
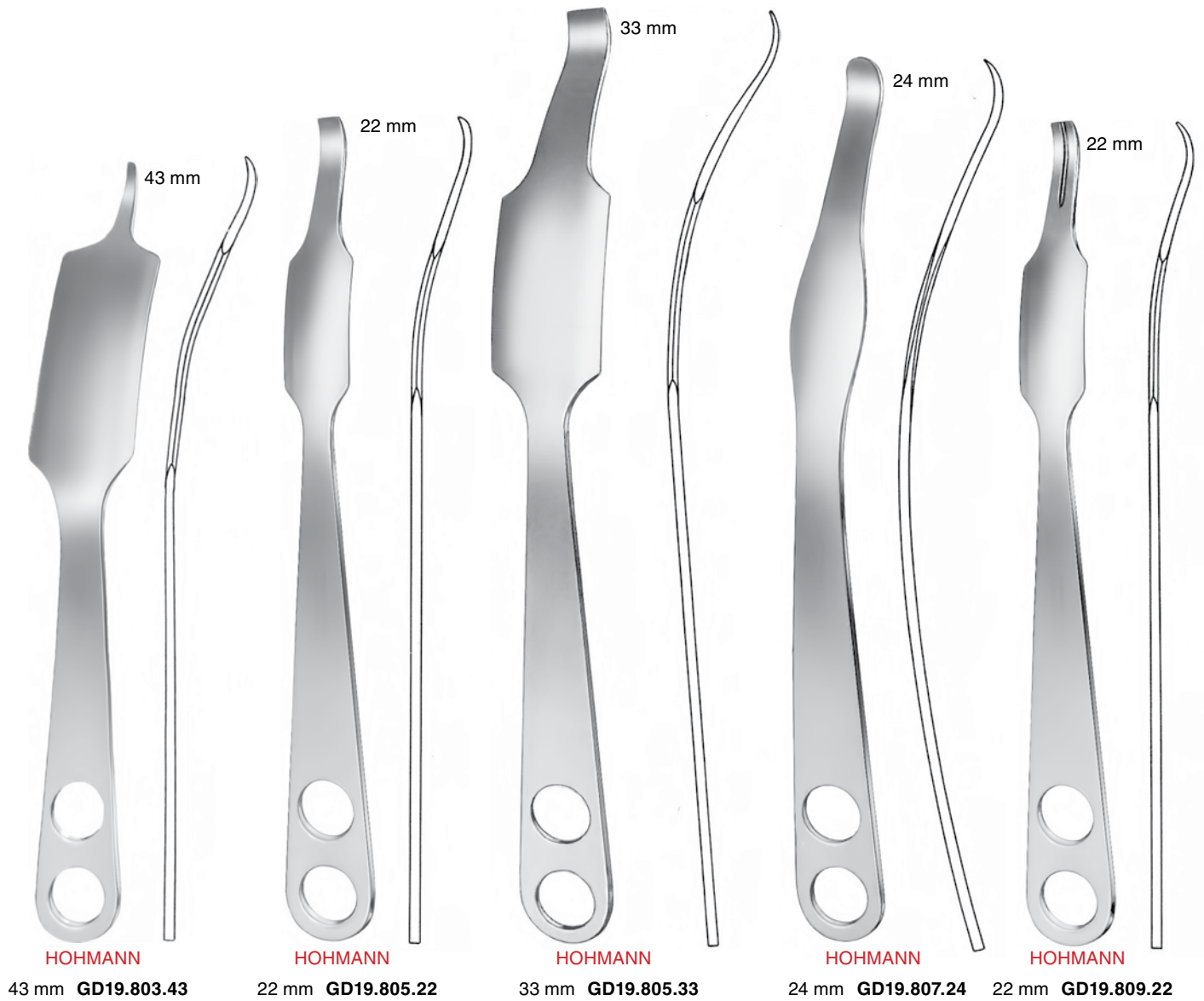



**Bone Surgery**  
**Knochenchirurgie**  
**Chirurgie osseuse**  
**Cirugía ósea**  
**Chirurgia ossea**

**GRAND**  
 DEVICES  
*The Grand Instruments Company*

Bone Levers  
 Knochenhebel  
 Leviers à os  
 Elevadores para huesos Elevatori per ossa



**BLOUNT**

26.0 mm **GD19.823.26**



**BLOUNT**

26.0 mm **GD19.825.26**

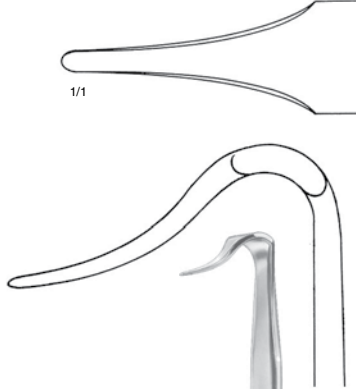

**BLOUNT**

17.5 mm **GD19.827.17**



**TAYLOR**

75 mm x 30 mm **GD19.831.16**  
 100 mm x 30 mm **GD19.833.16**  
 16.5 cm

Meniscotomes • Meniskotome  
 Meniscotomes • Meniscótomos  
 Meniscotomi



**SMILLIE**

17.0 mm **GD19.910.17**

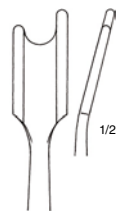

**GD19.911.17**  
 17.0 mm

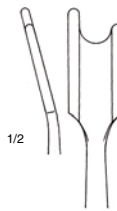

**GD19.913.17**  
 17.0 mm



**BIRCHER**

19.0 mm **GD19.915.19**



**BIRCHER**

19.0 mm **GD19.917.19**



**NEFF**

**GD19.921.22** 22.0 cm **GD19.923.22**



Tendon Strippers, Bone Files  
 Sehnenstripper, Knochenfeilen  
 Instruments à écorcher les tendons, limes à os  
 Separadores para tendones, limas para huesos  
 Scollatendini, lime per ossa



**BUNNELL**

**GD19.950.01 - GD19.950.05**  
 15.0 cm

24.5 mm **GD19.971.24**

22.0 mm **GD19.972.22**

27.0 mm **GD19.973.27**

**PUTTI**

30.0 mm **GD19.975.30**





Bone Surgery, Osteosynthesis  
Orthopädie, Osteosynthese  
Chirurgie osseuse, Ostéosynthèse  
Cirugía òsea, Osteosíntesis  
Chirurgia ossea, Osteosintesi  
骨外科, 骨合成



**GD20**





Comprimeter  
Komprimeter  
Comprimètre  
Torniquete  
Apparecchio per vuoto di sangue

**GRAND**<sup>®</sup>  
DEVICES  
*The Grand Instruments Company*

Compression Apparatus for producing blood vacuum in limbs  
Komprimeter zur Erzeugung von Blutleere in den Gliedern  
Appareil compressif permettant d'obtenir un milieu exsangue des membres  
Aparato de compresión para producir el vacío de sangre en los miembros  
Vacumetro per determinare vuoti di sangue nelle membra



**GD20.101.01**  
Compl.

Amputation, Fingers  
 Amputation, Finger  
 Amputation, doigts  
 Amputación, dedos  
 Amputazione, dita



12 mm **GD20.112.12**  
 15 mm **GD20.112.15**  
 18 mm **GD20.112.18**



**PERCY**  
**GD20.110.00**



**CHARRIERE**  
**GD20.112.00**

**GD20.116.99**



**CHARRIERE**  
 30.0 cm **GD20.116.30**

**GD20.118.99**



**SATTERLEE**  
 31.0 cm **GD20.118.31**



**LANGENBECK**  
 23.0 cm **GD20.120.23**



**GD20.160.01**



Compl. **GD20.1GD20.00**  
 incl. **GD20.1GD20.01**

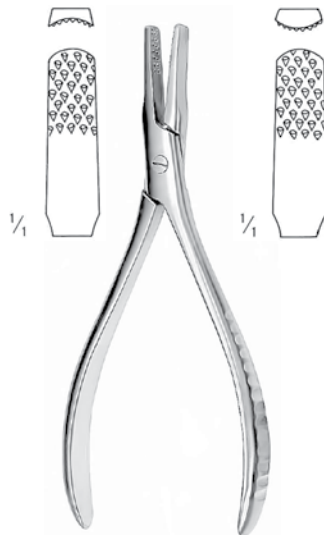

**RADOLF**  
 13.5 cm **GD20.162.13**



**DIMEDA**  
 17.0 cm **GD20.173.00**



**GD20.175.00**



Bone Hand Drills  
 Handbohrapparate  
 Perforateurs à main  
 Perforadores a mano  
 Perforatori a mano

**GRAND**  
 DEVICES  
 The Grand Instruments Company



Compl. 20 cm **GD20.210.20**

**GD20.210.10**

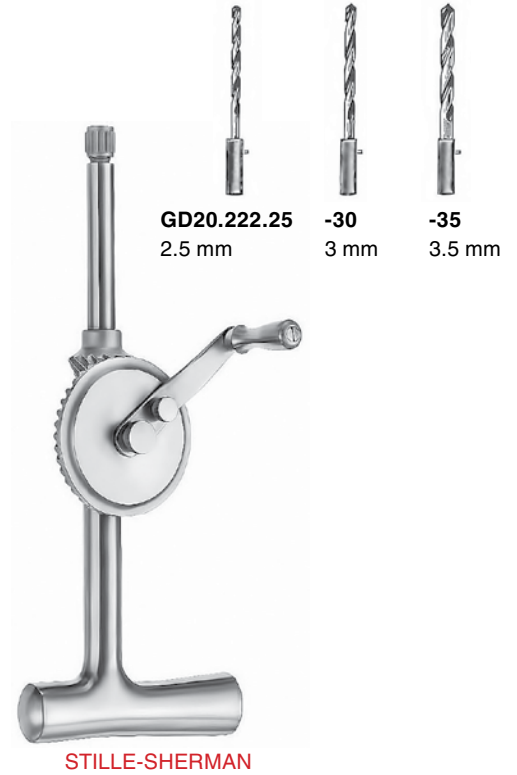

Compl. 24 cm **GD20.220.24**



**MOORE**  
 Compl. 28 cm **GD20.230.28**

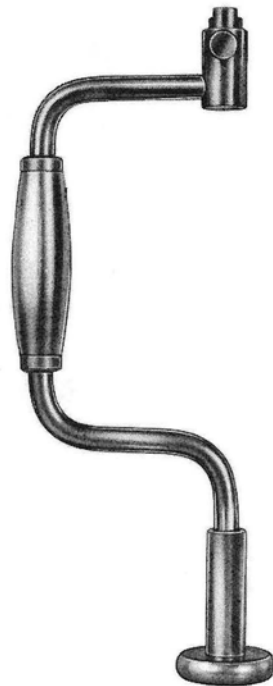

**HUDSON**  
 27 cm **GD20.240.27**  
 Compl. Incl. **GD20.242.09, -14, -16, -22, GD20.246.00**



Bone Hand Drills  
 Handbohrapparate  
 Perforateurs à main  
 Perforadores a mano  
 Perforatori a mano



**KIRSCHNER**  
 Compl. **GD20.250.00**



**GD20.252.00**



**GD20.260.00**  
 Compl.

**GD20.262.00**



**BUNNELL**  
 16.0 cm **GD20.270.00**



**RALK**  
**GD20.280.00**



Bone Drills  
Bohrapparate  
Perforateurs à os  
Perforadores para huesos  
Perforatori per ossa

**GRAND**  
DEVICES  
*The Grand Instruments Company*

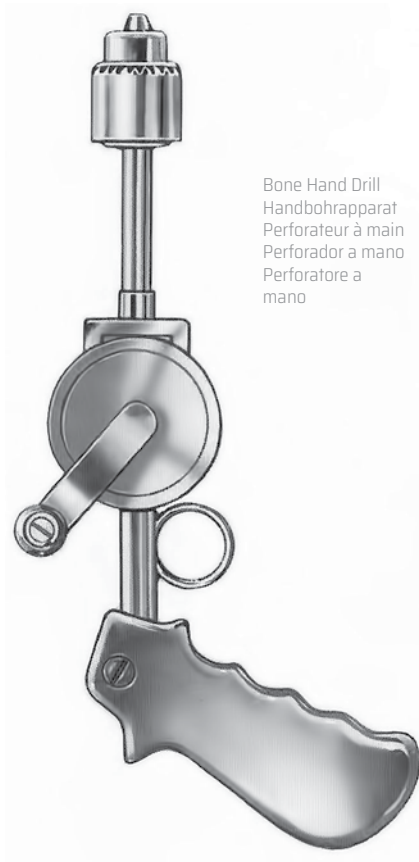

Bone Hand Drill  
Handbohrapparat  
Perforateur à main  
Perforador a mano  
Perforatore a  
mano

**GD20.290.00**



**GD20.296.00**

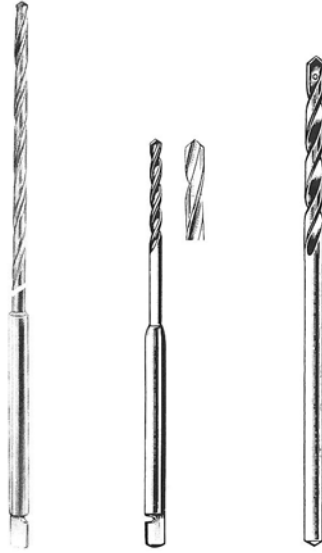

1.0 mm		GD20.352.10	GD20.354.10
1.2 mm		GD20.352.12	
1.5 mm		GD20.352.15	GD20.354.15
1.8 mm		GD20.352.18	
2.0 mm	GD20.350.20	GD20.352.20	GD20.354.20
2.2 mm		GD20.352.22	
2.5 mm	GD20.350.25	GD20.352.25	GD20.354.25
2.8 mm		GD20.352.28	GD20.354.28
3.0 mm	GD20.350.30	GD20.352.30	GD20.354.30
3.2 mm	GD20.350.32	GD20.352.32	GD20.354.32
3.5 mm	GD20.350.35	GD20.352.35	GD20.354.35
4.0 mm	GD20.350.40	GD20.352.40	GD20.354.40
5.0 mm	GD20.350.50	GD20.352.50	GD20.354.50
6.0 mm	GD20.350.60		GD20.354.60
7.0 mm	GD20.350.70		



mm Ø	DOYEN	DOYEN	DOYEN	DOYEN	ALBEE	ALBEE	BORCHARDT	TOTI
04	GD20.362.04	GD20.364.04						
06	GD20.362.06	GD20.364.06						
07							GD20.374.07	
08	GD20.362.08	GD20.364.08		GD20.368.08		GD20.372.08		GD20.378.08
10	GD20.362.10	GD20.364.10		GD20.366.10		GD20.372.10		
12	GD20.362.12	GD20.364.12	GD20.366.12		GD20.370.12	GD20.372.12		
13							GD20.376.13	
14	GD20.362.14	GD20.364.14						
15					GD20.370.15			
16	GD20.362.16	GD20.364.16						
25								GD20.377.25



Boring Instruments, Awls  
Bohrinstrumente, Pfrieme  
Instrumental á percer, poincons  
Instrumental para perforar, Escariadores  
Strumenti per perforazione, Lesine

**GRAND**  
DEVICES  
*The Grand Instruments Company*

Reamer  
Reibahlen  
Pointes-carrées  
Escariadores  
Punteruoli

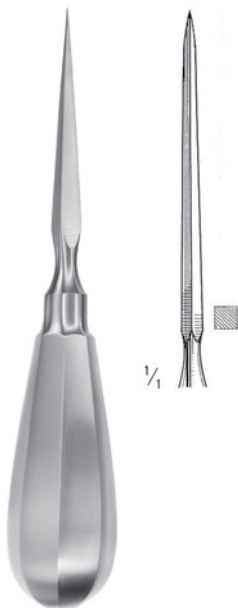

14.0 cm **GD20.392.14**



**PERTHES**  
21.0 cm **GD20.395.21**





available in packages with 10 pieces  
lieferbar in Packungen à 10 Stück  
disponibles en paquets de 10 pièces  
disponible en paquets de 10 unidades  
disponibili in confezioni da pezzi



Trocar tip  
Trokarspitze  
Pointe trocar  
Punta en forma de trócar  
Punte a trequarti

mm Ø	L = 60 mm	L = 120 mm	L = 140 mm	L = 160 mm	L = 310 mm
1.0	<b>GD20.406.10</b>	<b>GD20.412.10</b>	<b>GD20.414.10</b>	<b>GD20.416.10</b>	<b>GD20.431.10</b>
1.2	<b>GD20.406.12</b>	<b>GD20.412.12</b>	<b>GD20.414.12</b>	<b>GD20.416.12</b>	<b>GD20.431.12</b>
1.4	<b>GD20.406.14</b>	<b>GD20.412.14</b>	<b>GD20.414.14</b>	<b>GD20.416.14</b>	<b>GD20.431.14</b>
1.5	<b>GD20.406.15</b>	<b>GD20.412.15</b>	<b>GD20.414.15</b>	<b>GD20.416.15</b>	<b>GD20.431.15</b>
1.6	<b>GD20.406.16</b>	<b>GD20.412.16</b>	<b>GD20.414.16</b>	<b>GD20.416.16</b>	<b>GD20.431.16</b>
1.8	<b>GD20.406.18</b>	<b>GD20.412.18</b>	<b>GD20.414.18</b>	<b>GD20.416.18</b>	<b>GD20.431.18</b>
2.0	<b>GD20.406.20</b>	<b>GD20.412.20</b>	<b>GD20.414.20</b>	<b>GD20.416.20</b>	<b>GD20.431.20</b>
2.2	<b>GD20.406.22</b>	<b>GD20.412.22</b>	<b>GD20.414.22</b>	<b>GD20.416.22</b>	<b>GD20.431.22</b>
2.5				<b>GD20.416.25</b>	<b>GD20.431.25</b>

**KIRSCHNER**

**GD20.406.10 - GD20.431.25**

Available in packages with 10 pieces  
lieferbar in Packungen à 10 Stück  
disponibles en paquets de 10 pièces  
disponible en paquets de 10 unidades  
disponibili in confezioni da pezzi



Lancet tip  
Lanzenspitze  
Pointe lancéolaire  
Punta lanceolar  
Punte lanceolari

mm Ø	L = 310 mm
1.0	<b>GD20.432.10</b>
1.2	<b>GD20.432.12</b>
1.5	<b>GD20.432.15</b>
1.6	<b>GD20.432.16</b>
1.8	<b>GD20.432.18</b>
2.0	<b>GD20.432.20</b>
2.2	<b>GD20.432.22</b>
2.5	<b>GD20.432.25</b>

**KIRSCHNER**

**GD20.432.10 - GD20.432.25**



STEINMANN Pins  
STEINMANN Nägel  
STEINMANN clous à os  
STEINMANN Clavos p. huesos  
STEINMANN chiodi per ossa

L cm	
13	<b>GD20.490.13</b>
14	<b>GD20.490.14</b>
15	<b>GD20.490.15</b>
16	<b>GD20.490.16</b>
18	<b>GD20.490.18</b>
20	<b>GD20.490.20</b>
21	<b>GD20.490.21</b>

**STEINMANN**

**GD20.490.13 - GD20.490.21**





Extension Bow  
 Exentionsbügel  
 Etriers à exention  
 Estribos para extensión  
 Archi per estensione

**GRAND**  
 DEVICES  
*The Grand Instruments Company*

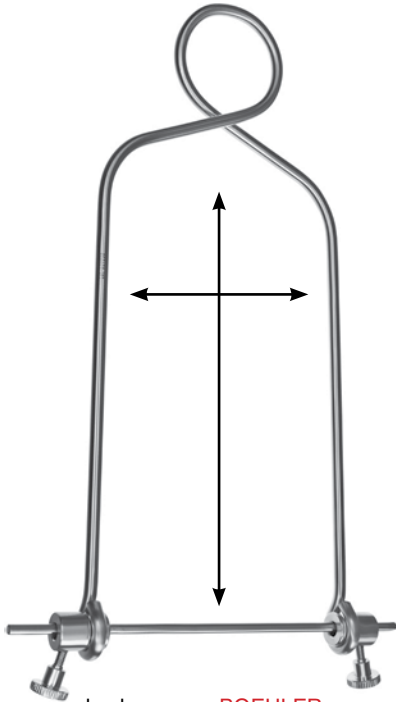

h x b cm **BOEHLER**  
 16.0 x 9.0 **GD20.502.16**  
 16.0 x 11.0 **GD20.502.21**

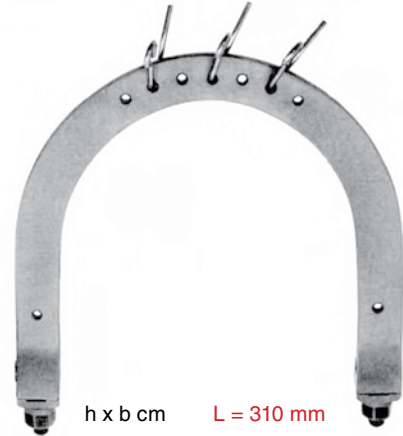

h x b cm **L = 310 mm**  
 6.0 x 5.0 **GD20.512.06**  
 9.5 x 7.0 **GD20.512.09**  
 10.5 x 10.5 **GD20.512.10**  
 9.5 x 11.0 **GD20.512.11**  
 12.0 x 12.0 **GD20.512.12**  
 13.5 x 13.0 **GD20.512.13**  
 15.5 x 15.5 **GD20.512.15**  
 20.0 x 15.5 **GD20.512.20**



h x b cm  
 18.0 x 10.0 **GD20.514.18**  
 27.0 x 16.0 **GD20.514.27**



**GD20.515.01**



**GD20.515.02**



**KIRSCHNER U.S.**

**GD20.518.01**  
 small • klein • petit • pequeño • piccolo  
**GD20.518.02**  
 large size • groß • grand • grande  
**GD20.518.03**  
 extra large size • extra groß  
 extra grand • extra grande



**GD20.519.01**



**GD20.519.02**

Bone Wire and Instruments  
 Knochendraht und -Instrumente  
 Fil à os et instruments  
 Hilo para huesos e instrumentos  
 Filo per ossa e strumenti



10 m

soft  
 weich  
 souple  
 blando  
 morbido

mm Ø L = 310 mm

- 0.2 **GD20.530.02**
- 0.3 **GD20.530.03**
- 0.4 **GD20.530.04**
- 0.5 **GD20.530.05**
- 0.6 **GD20.530.06**
- 0.7 **GD20.530.07**
- 0.8 **GD20.530.08**
- 0.9 **GD20.530.09**
- 1.0 **GD20.530.10**
- 1.1 **GD20.530.11**
- 1.2 **GD20.530.12**
- 1.5 **GD20.530.15**



**LOUTE**

21.0 cm **GD20.531.21**

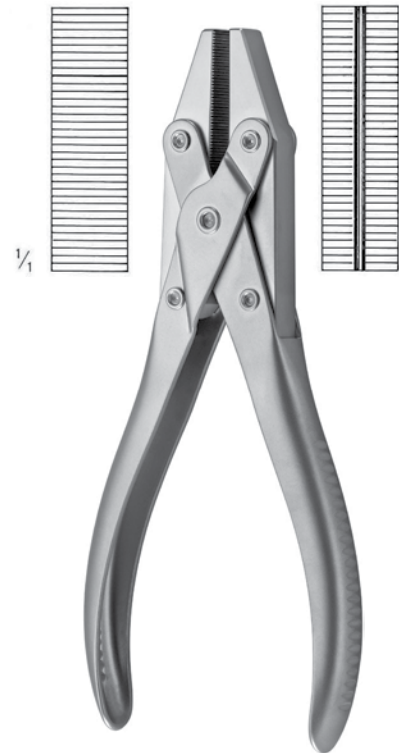

17.0 cm **GD20.532.17**

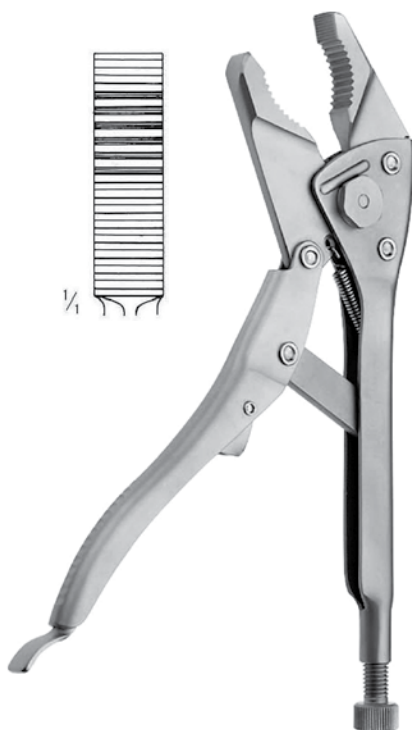

**GRIP**

18.0 cm **GD20.533.18**

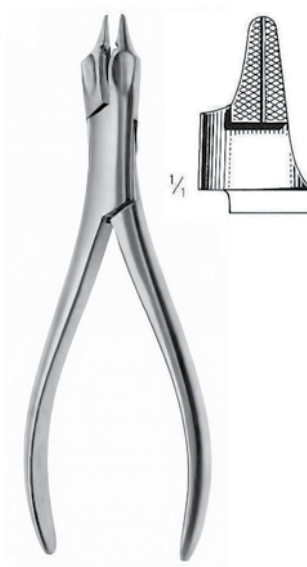

15.0 cm **GD20.534.15**

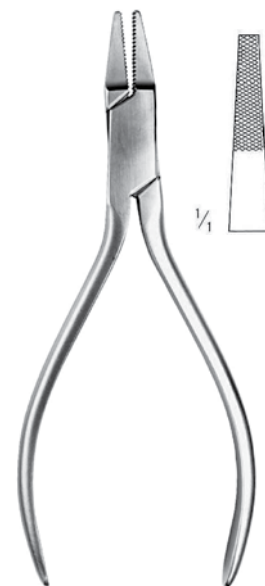

14.0 cm **GD20.536.14**



Bone Surgery  
 Knochenchirurgie  
 Chirurgie osseuse  
 Ciurgia ósea  
 Chirurgia ossea

**GRAND**  
 DEVICES  
 The Grand Instruments Company



16.0 cm **GD20.540.16**



15.0 cm **GD20.542.15**



22.0 cm **GD20.545.22**

TC-Lined  
 Mit TC-Einsätzen  
 A mors TC  
 Con bocas TC  
 Con morso TC

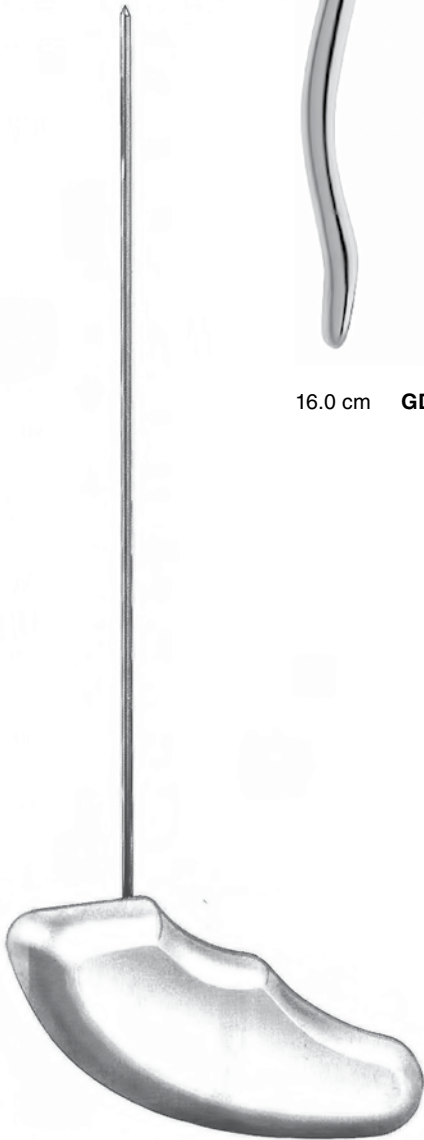

mm Ø  
 2.4 **GD20.560.24**  
 3.2 **GD20.560.32**  
 4.8 **GD20.560.48**  
 6.4 **GD20.560.64**



**GD20.562.24**  
 f./p. Ø 2.4 mm



**GD20.562.32**  
 3.2 mm



**GD20.562.48**  
 4.8 mm



**GD20.562.64**  
 6.4 mm

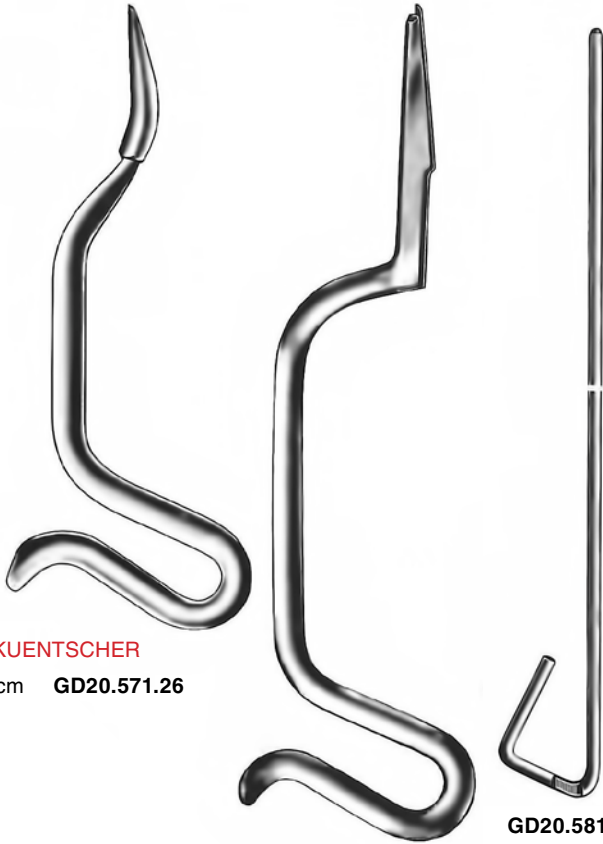

**KUENTSCHER**  
 26.0 cm **GD20.571.26**

**KUENTSCHER**  
 35.0 cm **GD20.573.35**

**GD20.581.35**  
**GD20.585.60**

mm Ø	L = 35 mm	L = 46 mm	L = 60 mm
2.5	<b>GD20.581.35</b>	<b>GD20.581.46</b>	
3.0	<b>GD20.582.35</b>	<b>GD20.582.46</b>	
3.5	<b>GD20.583.35</b>	<b>GD20.583.46</b>	<b>GD20.583.60</b>
4.0	<b>GD20.584.35</b>	<b>GD20.584.46</b>	<b>GD20.584.60</b>
5.0	<b>GD20.585.35</b>	<b>GD20.585.46</b>	<b>GD20.585.60</b>



**KUENTSCHER**  
 21.0 cm **GD20.586.21**



**KUENTSCHER**  
 21.0 cm **GD20.588.21**



$\frac{1}{3}$  **GD20.590.01**  $\frac{1}{3}$  **GD20.590.02**



$\frac{1}{3}$  **GD20.590.03**



**GD20.590.04**



**KUENTSCHER**  
 63.0 cm **GD20.590.00**

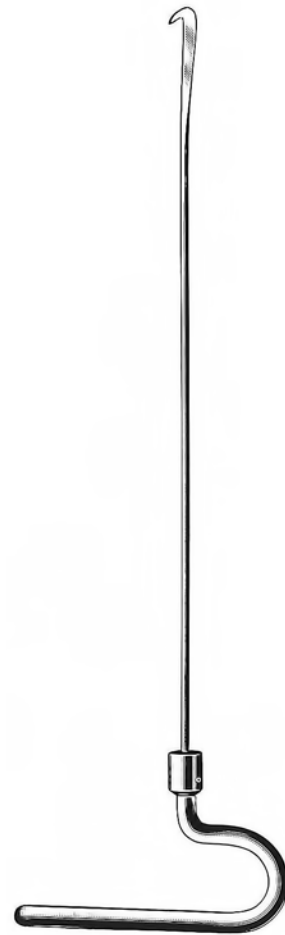

mm Ø  
 29 **GD20.596.29**  
 37 **GD20.596.37**  
 42 **GD20.596.42**  
 49 **GD20.596.49**



**GD20.598.30**



Osteosynthesis Instruments  
Instrumente zur Osteosynthese  
Instruments pour ostéosynthèse  
Instrumentos para osteosíntesis  
Strumenti per osteosintesi

**GRAND**  
DEVICES  
The Grand Instruments Company

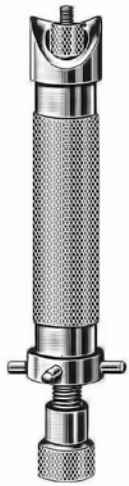

LLOYD

20.0 cm **GD20.602.20**



LANE

25.0 cm **GD20.620.25**



WILLIAMS

24.0 cm **GD20.624.24**



2.5 mm **GD20.628.25**  
3.5 mm **GD20.628.35**



LANE

25.0 cm **GD20.632.25**



LANE

18.0 cm **GD20.635.18**



KUENTSCHER

23.0 cm **GD20.637.23**



LANE

22.0 cm **GD20.639.22**

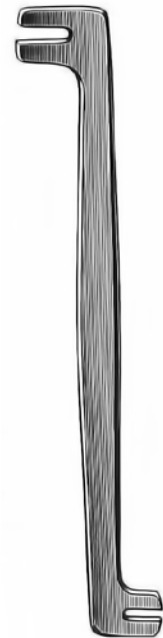

LANE

18.0 cm **GD20.640.18**





**GD20.645.00**



13.0 cm **GD20.642.00**

14.5 cm **GD20.643.01**

14.5 cm **GD20.643.01**

13.5 cm **GD20.650.14**



**GD20.670.00**



Osteosynthesis Instruments  
Instrumente zur Osteosynthese  
Instruments pour ostéosynthèse  
Instrumentos para osteosíntesis  
Strumenti per osteosintesi

**GRAND**  
DEVICES  
*The Grand Instruments Company*

Instrument Set for Cannulated Screws  
Instrumentarium zum Einbringen von Hohlschrauben  
Instrumentation pour l'application des vis à perforation longitudinale  
Instrumental para la aplicación de tornillos de perforación longitudinal  
Strumentario per viti cannulate



mm Ø

4.5 **GD20.802.45**  
7.0 **GD20.802.70**



5.0 mm **GD20.810.05**

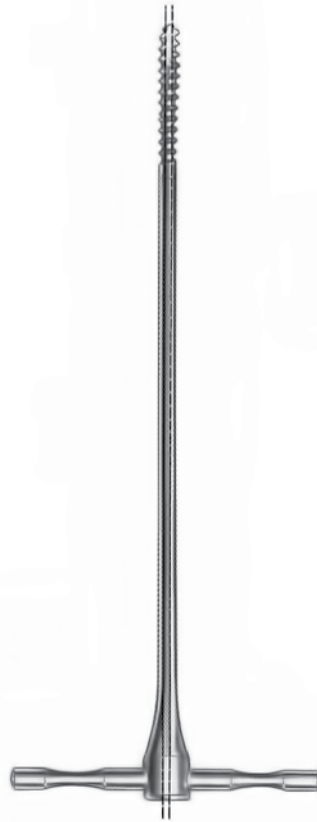

mm Ø

4.5 **GD20.812.45**  
7.0 **GD20.812.70**

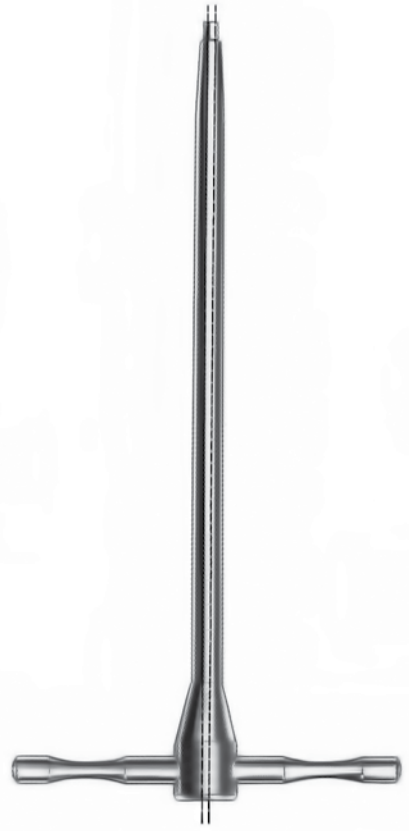

mm Ø

2.5 **GD20.816.25**  
3.5 **GD20.816.35**  
5.0 **GD20.816.50**



**GD20.820.00**

Ophthalmology  
Ophthalmologie  
Ophtalmologie  
Ofthalmología  
Ofthalmologia  
眼科



**GD** 21-22





Ophthalmology  
Ophthalmologie  
Ophtalmologie  
Ofthalmología  
Ofthalmologia

**GRAND**  
DEVICES  
The Grand Instruments Company

Sperrelevatoren  
Eye Specula  
Blépharostats  
Blefarostatos  
Blefarostati

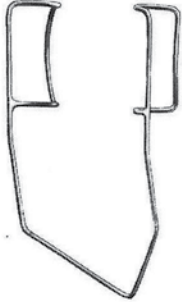

**BARRAQUER (Collibri)**  
3.0 cm **GD21.101.03**  
4.0 cm **GD21.101.04**



**BOWMAN**  
7.0 cm **GD21.104.07**

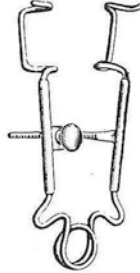

**CRITCHETT**  
7.0 cm **GD21.105.06**



**SMITH**  
5.0 cm **GD21.106.05**



**CLARK**  
8.0 cm **GD21.107.08**



**GRAEFE**  
7.0 cm **GD21.109.06**  
9.0 cm **GD21.109.07**



**WEEK**  
8.0 cm **GD21.110.08**

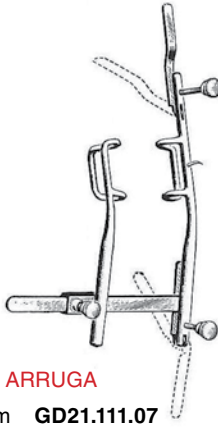

**ARRUGA**  
7.0 cm **GD21.111.07**  
• rechts • right • à droite  
• a la derecha • destro

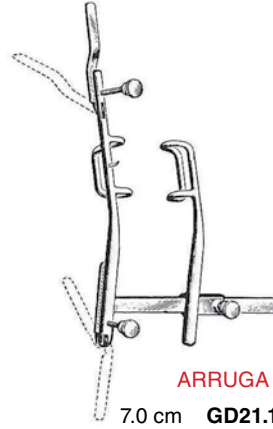

**ARRUGA**  
7.0 cm **GD21.113.07**  
left • à gauche • a la izquierda  
• sinistro

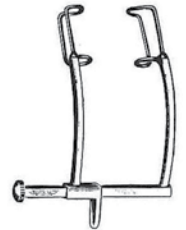

**MURDOCK**  
5.0 cm **GD21.115.05**

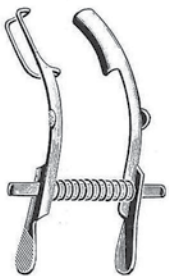

**MELLINGER-AXENFELD**  
7.0 cm **GD21.121.07**

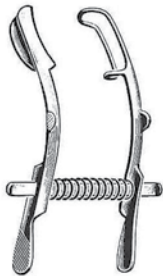

**MELLINGER-AXENFELD**  
7.0 cm **GD21.123.07**

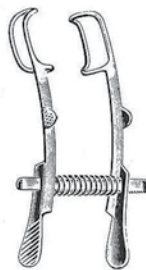

**MELLINGER**  
5.0 cm **GD21.125.05**  
7.0 cm **GD21.125.07**



**LISTER-BURCH**  
8.0 cm **GD21.127.08**



**WILLIAMS**  
8.0 cm **GD21.128.08**



Eye Specula  
 Sperrelevatoren  
 Blépharostats  
 Blefarostatos  
 Blefarostati

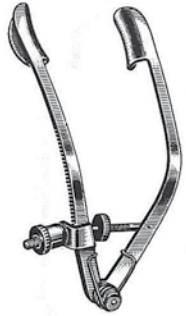

**LANCASTER**  
 7.0 cm **GD21.129.07**



**ZIEGLER**  
 7.0 cm **GD21.130.07**



**CASTROVIEJO**  
 8.0 cm **GD21.132.08**

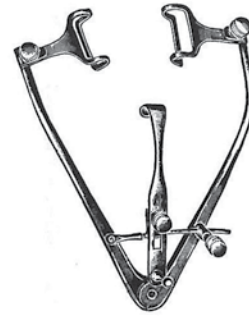

**PARK**  
 8.0 cm **GD21.133.08**



**MUELLER**  
 7.0 cm **GD21.135.07**



**GOLDSTEIN**  
 3.0 cm **GD21.137.07**



**STEVENSON**  
 7.0 cm **GD21.139.07**



**JAEGER**  
 11.0 cm **GD21.150.11**

Lid Plate  
 Lidplatte  
 Plaque à paupières  
 Placa para párpados  
 Placca per palpebre

Cataract Knives  
 Starmesser  
 Couteaux à cataracte  
 Cuchillos para cataratá  
 Coltelli per cataratta



$\frac{1}{4}$   
**GD21.170.00**  
 Fig. 0

**GRAEFE**

**GD21.170.00 - GD21.170.03**



**GD21.170.01**  
 Fig. 1



**GD21.170.02**  
 Fig. 2



**GD21.170.03**  
 Fig. 3



**DEUSCHMANN**

13.0 cm **GD21.172.13**



Various Eye Knives  
 Verschiedene Augenmesser  
 Couteaux oculaires divers  
 Cuchillos oculares varios  
 Coltelli diversi per oculistica

**GRAND**  
 DEVICES  
 The Grand Instruments Company

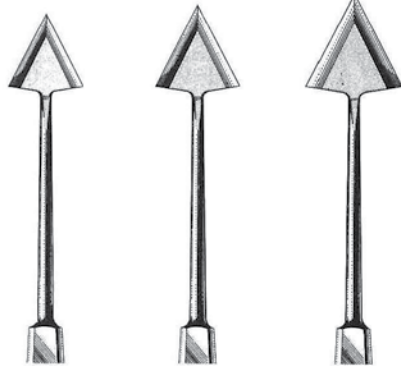

**JAEGER**

**GD21.180.01** **GD21.180.02** **GD21.180.03**  
 Fig. 1 Fig. 2 Fig. 3



**JAEGER 45°**

**GD21.181.01** **GD21.181.02** **GD21.181.03**  
 Fig. 1 Fig. 2 Fig. 3

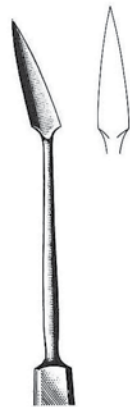

**BERENS**

**GD21.180.01 - GD21.218.12**

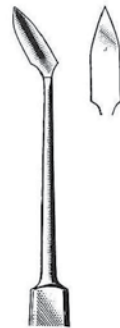

**CASTROVIEJO**

13.0 cm **GD21.183.13** 13.0 cm **GD21.185.13**



**GRAEFE**

13.0 cm **GD21.187.13**



**KNAPP**

**GD21.202.01**  
 Fig. 1



**GD21.202.02**  
 Fig. 2



**GD21.202.03**  
 Fig. 3



**ZIEGLER**

**GD21.210.01** **GD21.210.02** **GD21.210.03**  
 Fig. 1 Fig. 2 Fig. 3  
 5.0 mm 6.0 mm 7.0 mm



**DEAN**

12.5 cm **GD21.213.12**



**BOWMAN**

**GD21.214.04**  
 13.0 cm  
 0.4 mm



**GD21.214.08**  
 13.0 cm  
 0.8 mm



**WHEELER**

12.0 cm **GD21.218.12**



**ZIEGLER**  
**GD21.221.11**  
 11.0 cm  
 3.5 mm



**SATO**  
**GD21.226.12**  
 12.5 cm



**TOOK**  
**GD21.228.12**  
 12.0 cm



**GILL**  
**GD21.231.12**  
 12.0 cm



**ELSCHNIG**  
**GD21.233.13**  
 13.0 cm



**KUHNT**  
**GD21.240.01**  
 Fig. 1



**KUHNT**  
**GD21.240.02**  
 Fig. 2



**KUHNT**  
**GD21.240.03**  
 Fig. 3



**KUHNT**  
**GD21.240.04**  
 Fig. 4



**PATON**  
**GD21.245.12**  
 12.0 cm



**LUNDSGAARD**  
**GD21.251.12**  
 12.0 cm



**GUYTON-LUNDSGAARD**  
**GD21.253.12**



**BARRKAN**  
**GD21.256.12**



**SCHEIE**  
**GD21.258.12**



**BURCH**  
**GD21.2GD22.12**



**PAUFIQUE**  
**GD21.271.11**



**BARRAQUER**  
**GD21.273.13**



**GD21.304.12**



**GD21.305.12**



**BOWMAN**  
**GD21.308.12**



**BOWMAN**  
**GD21.309.12**



**GD21.310.13**



**GD21.311.13**



**LEVINSON**  
**GD21.314.13**



**FRANCIS**  
**GD21.321.12**



**DAVIS**  
**GD21.325.13**  
 13.0 cm



Ophthalmology  
 Ophthalmologie  
 Ophthalmologie  
 Oftalmología  
 Oftalmologia

**GRAND**  
 DEVICES  
*The Grand Instruments Company*



**LA FORCE**  
 GD21.327.12



**DIX**  
 GD21.330.13

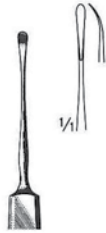

**ELLIS**  
 GD21.331.11



**WALTON**  
 GD21.332.12



**WALTON**  
 GD21.334.12



**ALVIS**  
 GD21.336.12

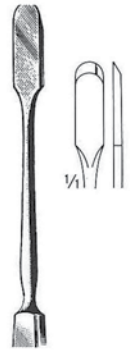

**GREEN**  
 GD21.340.13



**ROLLET**  
 GD21.342.12



**GD21.351.01**  
 Fig. 1



**GD21.351.02**  
 Fig. 2



**GD21.351.03**  
 Fig. 3



**JAMESON**  
 GD21.353.13



**GREEN**  
 GD21.355.13



**STEVENS**  
 GD21.357.13



**GD21.363.01**  
 Fig. 1



**GD21.363.02**  
 Fig. 2



**O'CONNOR**  
 GD21.370.12



**WIENER**  
 GD21.372.13



**WIENER**  
 GD21.373.13



**ROLLET**  
 GD21.376.13



**KNAPP**  
 GD21.377.13



**GRAEFE**  
 GD21.380.13



**GRAEFE**  
 GD21.381.13



**GRAEFE**  
 GD21.383.13



**BECKER**  
 GD21.386.13

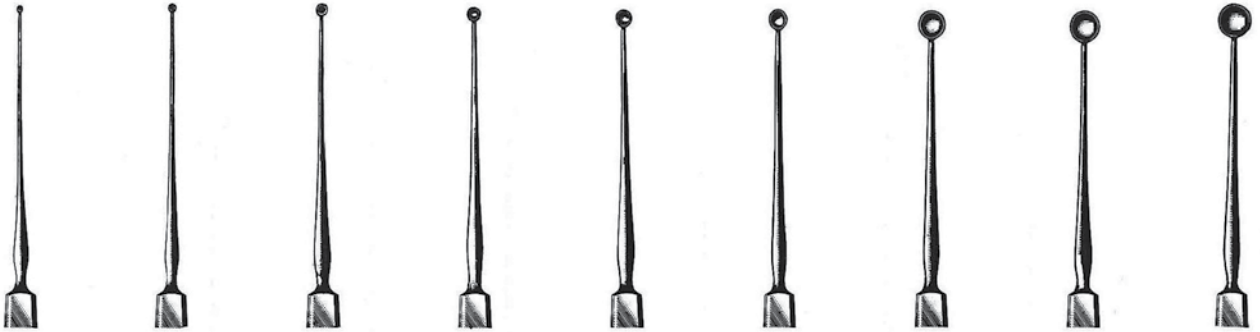

MEYHOEFER

- |                    |                    |                    |                    |                    |                    |                    |                    |                    |
|--------------------|--------------------|--------------------|--------------------|--------------------|--------------------|--------------------|--------------------|--------------------|
| <b>GD21.402.05</b> | <b>GD21.402.10</b> | <b>GD21.402.15</b> | <b>GD21.402.18</b> | <b>GD21.402.20</b> | <b>GD21.402.25</b> | <b>GD21.402.35</b> | <b>GD21.402.40</b> | <b>GD21.402.45</b> |
| 0.5 Ø mm           | 1.0 Ø mm           | 1.5 Ø mm           | 1.8 Ø mm           | 2.0 Ø mm           | 2.5 Ø mm           | 3.5 Ø mm           | 4.0 Ø mm           | 4.5 Ø mm           |

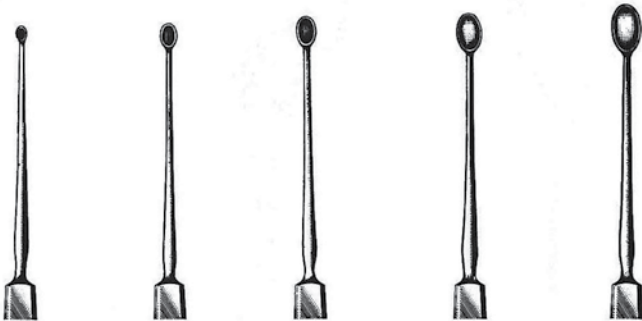

HEBRA

- |                    |                    |                    |                    |                    |
|--------------------|--------------------|--------------------|--------------------|--------------------|
| <b>GD21.404.10</b> | <b>GD21.404.20</b> | <b>GD21.404.25</b> | <b>GD21.404.30</b> | <b>GD21.404.35</b> |
| 1.0 Ø mm           | 2.0 Ø mm           | 2.5 Ø mm           | 3.0 Ø mm           | 3.5 Ø mm           |



AXENFELD  
 GD21.407.13

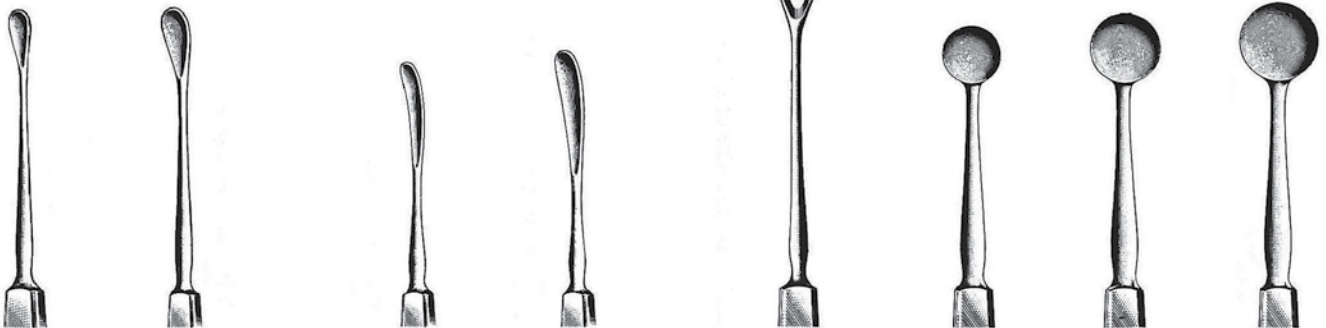

GRAEFE

- |                    |                    |
|--------------------|--------------------|
| <b>GD21.410.01</b> | <b>GD21.410.02</b> |
|--------------------|--------------------|

DAVIEL

- |                    |                    |
|--------------------|--------------------|
| <b>GD21.412.01</b> | <b>GD21.412.02</b> |
|--------------------|--------------------|

KNAPP

- |                    |
|--------------------|
| <b>GD21.414.02</b> |
|--------------------|

BUNGE

- |                    |                    |                    |
|--------------------|--------------------|--------------------|
| <b>GD21.420.01</b> | <b>GD21.420.02</b> | <b>GD21.420.03</b> |
|--------------------|--------------------|--------------------|





Wire Loops  
Drahtschlingen  
Anses  
Asas  
Anse

**GRAND**  
DEVICES  
The Grand Instruments Company



LANG

GD21.424.13



WEBER

GD21.441.01  
Fig. 1



GD21.441.02  
Fig. 2



SNELLEN

GD21.443.13



WILDER

GD21.445.13  
Fig. 1



GD21.447.13  
Fig. 2



ARLT

GD21.449.01 GD21.449.02

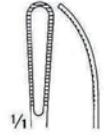

Protector  
Schützer  
Protecteur  
Protettore

• Cauter • Kauter  
• Cautère • Cauterio

Iris • Iride



WECKER

GD21.461.13



GD21.462.13



CULLER

GD21.467.13

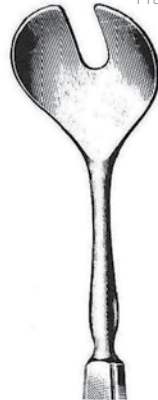

WELLS

GD21.482.20



ARRUGA

GD21.485.13

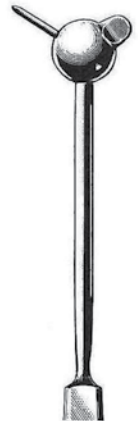

WADSWORTH-TODD

GD21.487.14

Zyklodialyse • Cyclodialysis • Cyclodialyse • Ciclodíalisis • Ciclodialisi



BANGERTER

GD21.501.06 GD21.501.10 GD21.501.12  
6.0 mm 10.0 mm 12.0 mm

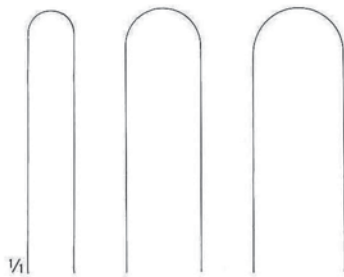

GD21.511.13 - GD21.517.09



CASTROVIEJO

GD21.511.13  
1.2 x 10 mm



CASTROVIEJO

GD21.513.14  
1.5 x 15 mm



ELSCHNIG

GD21.515.14  
1.2 x 12 mm



CASTROVIEJO

GD21.517.09  
0.8 x 15 mm

Cyclodialysis Spatulae, Foreign Body Instruments  
 Zyklotodialyse-Spatel, Fremdkörper-Instrumente  
 Spatules à cyclodialyse, Instruments à corps étranger  
 Espátulas para ciclodiálisis, Instrumentos para cuerpos extraños  
 Spatole per ciclodialisi, Strumenti per corpi estranei



**CASTROVIEJO**  
 GD21.521.12



**WHEELER**  
 GD21.523.12



**CASTROVIEJO**  
 0.5 mm GD21.525.05  
 0.75 mm GD21.525.07  
 1.0 mm GD21.525.10



**DIX**  
 GD21.542.12



**DIX**  
 GD21.544.12



**DIX**  
 GD21.546.13



**DIX**  
 GD21.548.13

Markers  
 Markier-Instrumente  
 Marqueurs  
 Marcadores  
 Marcatori

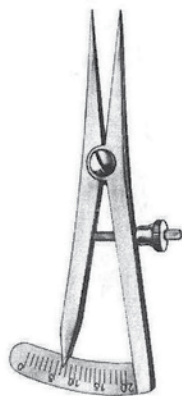

**CASTROVIEJO**  
 GD21.583.07  
 0 - 20 mm



**CONNIN-AMSLER**  
 GD21.589.13



**DASTOOR**  
 GD21.590.06  
 6.0 cm

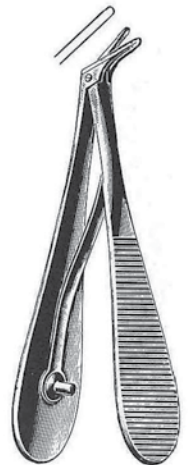

**HOLTH**  
 GD21.593.09





Ophthalmology  
Ophthalmologie  
Ophtalmologie  
Oftalmología  
Oftalmologia

**GRAND**  
DEVICES  
The Grand Instruments Company

Lachrymal Dilators  
Tränenang-Dilatatoren  
Dilatateurs pour canal lacrymal  
Dilatadores para canal lacrimal  
Dilatatori per canale lacrimale

Lachrymal Probes  
Tränenkanal-Sonden  
Stylets pur le canal lacrymal  
Estiletos para canal lacrimal  
Specilli per canale lacrimale

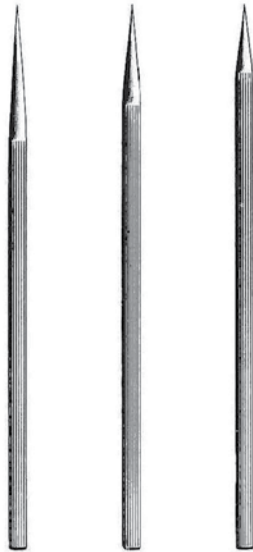

**WILDER**

GD21.602.01 GD21.602.02 GD21.602.03



**ZIEGLER**

Fig.1/2 GD21.605.12  
Fig.3/4 GD21.605.34  
Fig.5/6 GD21.605.56



**CASTROVIEJO**

GD21.608.12



**BOWMAN**

GD21.614.00 Fig.00/0 GD21.616.00  
GD21.614.01 Fig.0/1 GD21.616.01  
GD21.614.12 Fig.1/2 GD21.616.12  
GD21.614.23 Fig.2/3 GD21.616.23  
GD21.614.34 Fig.3/4 GD21.616.34  
GD21.614.45 Fig.4/5 GD21.616.45  
GD21.614.56 Fig.5/6 GD21.616.56  
GD21.614.67 Fig.6/7 GD21.616.67  
GD21.614.78 Fig.7/8 GD21.616.78



**GRAEFE**

7 cm / 1 mm GD21.802.07

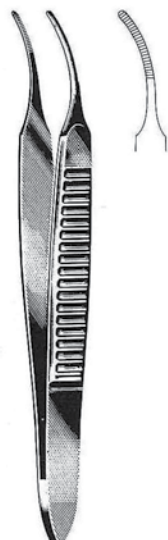

**GRAEFE**

7 cm / 1 mm GD21.803.07



**GRAEFE**

7 cm / 1 mm GD21.804.07

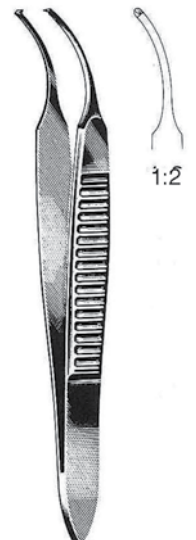

**GRAEFE**

7 cm / 1 mm GD21.805.07

Fig. 00 01 23 4 5 6 7 8  
ø mm 0,7 0,8 0,9 1,1 1,3 1,4 1,5 1,6 1,8 1,9

Iris Forceps  
Iris Pinzetten  
Pinces à iris  
Pinzas para iris  
Pinze per iride



**GRAEFE**  
**GD21.810.10**  
10 cm



**GRAEFE**  
**GD21.811.10**  
10.0 cm



**GRAEFE**  
**GD21.813.10**  
10.0 cm



**GRAEFE**  
**GD21.820.10**  
10.0 cm



**GRAEFE**  
**GD21.821.10**  
10.0 cm



**GRAEFE**  
**GD21.823.10**  
10.0 cm



**STEVENS**  
**GD21.830.10**  
10.5 cm



**STEVENS**  
**GD21.831.10**  
10.5 cm



**STEVENS**  
**GD21.833.10**  
10.5 cm



**STEVENS**  
**GD21.840.10**  
10.5 cm

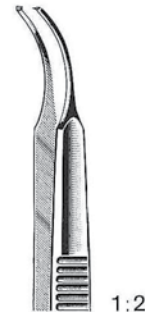

**STEVENS**  
**GD21.841.10**  
10.5 cm

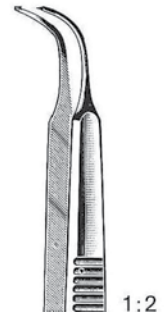

**STEVENS**  
**GD21.843.10**  
10.5 cm



Ophthalmology  
Ophthalmologie  
Ophtalmologie  
Oftalmología  
Oftalmologia

**GRAND**  
DEVICES  
*The Grand Instruments Company*



**FOERSTER**  
**GD21.850.08**  
8.5 cm

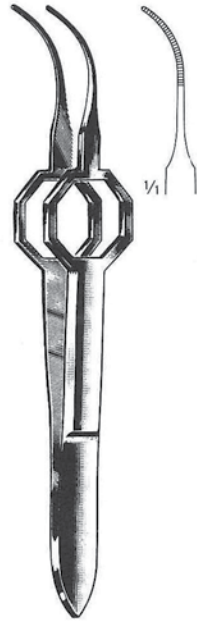

**FOERSTER**  
**GD21.851.08**  
8.5 cm



**FOERSTER**  
**GD21.852.08**  
8.5 cm

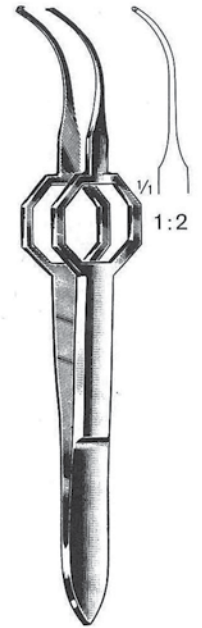

**FOERSTER**  
**GD21.853.08**  
8.5 cm



**HESS**  
**GD21.855.07**  
7 cm / 0.3 mm

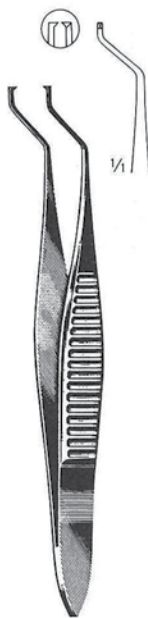

**HESS**  
**GD21.857.07**  
7 cm / 0.3 mm



**GILL**  
**GD21.861.07**  
7 cm / 0.3 mm

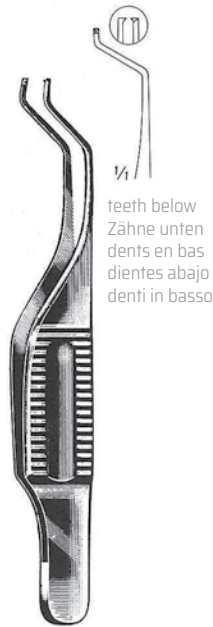

**GILL-HESS**  
**GD21.863.07**  
7.5 cm / 0.3 mm

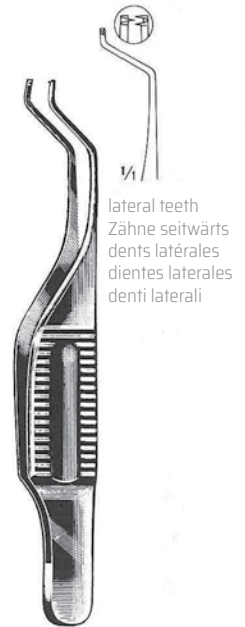

**GILL-HESS**  
**GD21.865.07**  
7.5 cm / 0.3 mm

Iris, Strabismus Forceps  
 Iris-, Strabismus-Pinzette  
 Pinces à iris et à strabisme  
 Pinzas para iris y para estrabismo  
 Pinze per iride e per strabismo

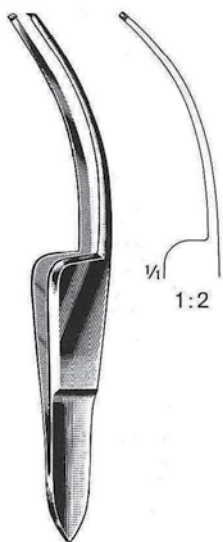

**FISCHER**  
**GD21.869.07**  
 7.0 cm

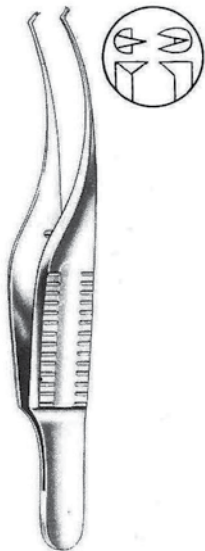

**BARRAQUER-KATZIN**  
**GD21.881.07**  
 7.0 cm / 0.4 mm

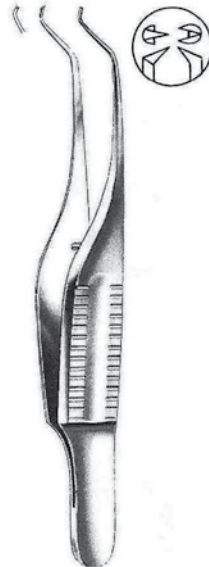

**TROUTMAN (Colibri)**  
**GD21.883.07**  
 7.0 cm / 12 mm

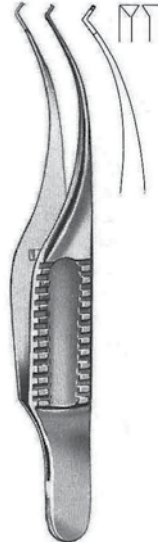

**BARRAQUER (Colibri)**  
**GD21.885.07**  
 7.0 cm / 12 mm

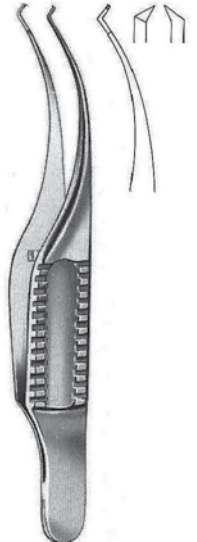

**BARRAQUER (Colibri)**  
**GD21.887.07**  
 7.0 cm / 12 mm



**KIRBY-ARTHUR**  
**GD21.891.09**  
 9.0 cm / 0.2 mm



**KIRBY-ARTHUR**  
**GD21.893.09**  
 9.0 cm / 0.2 mm



**McCULLOUGH**  
**GD21.902.09**  
 9.5 cm



**McCULLOUGH**  
**GD21.904.09**  
 9.5 cm

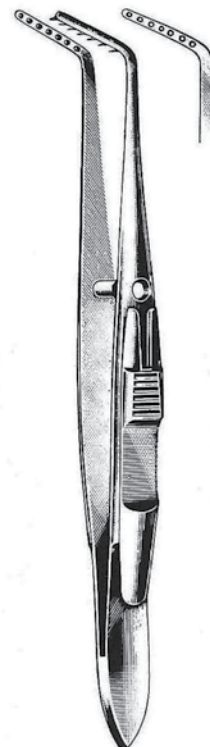

**JAMESON**  
**GD21.907.10**  
 L - 10 cm



**JAMESON**  
**GD21.909.10**  
 L - 10 cm





Strabismus Forceps  
 Strabismus-Pinzetten  
 Pincès à strabisme  
 Pinzas para estrabismo  
 Pinze per strabismo

**GRAND**  
 DEVICES  
 The Grand Instruments Company



**BONACCOLTO**  
**GD21.914.10**  
 10.0 cm



**BONACCOLTO**  
**GD21.916.10**  
 10.0 cm



**BONACCOLTO**  
**GD21.920.11**  
 11.0 cm



**DASTOOR**  
**GD21.924.11**  
 11.0 cm



**DASTOOR**  
**GD21.926.11**  
 11.0 cm

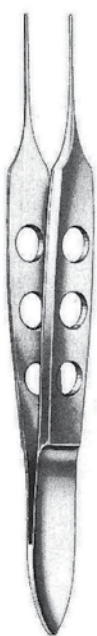

**BISHOP-HARMAN**  
**GD21.940.05**  
 8.5 cm / 0.5 mm



**BISHOP-HARMAN**  
**GD21.940.08**  
 8.5 cm / 0.8 mm



**BISHOP-HARMAN**  
**GD21.942.05**  
 8.5 cm / 0.5 mm



**BISHOP-HARMAN**  
**GD21.942.08**  
 8.5 cm / 0.8 mm

Iris Forceps • Iris-Pinzetten • Pincès à iris •  
 Pinzas para iris • Pinze per iride



**Mod. Bonn**  
**GD21.944.07**  
 7.0 cm / 0.12 mm



**Mod. Bonn**  
**GD21.946.07**  
 7.0 cm / 0.12 mm



• Iris, Muscle Forceps • Iris-,  
Muskel-Pinzetten • Pincès à iris,  
mus-culaires • Pinzas para iris,  
muscu-lares • Pinze per iride,  
muscolari

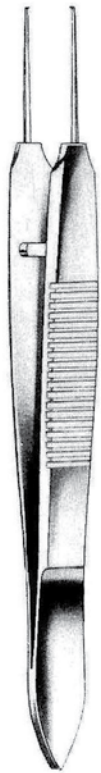

**Mod. Bonn**  
**GD21.946.10**  
10.0 cm / 0.12 mm

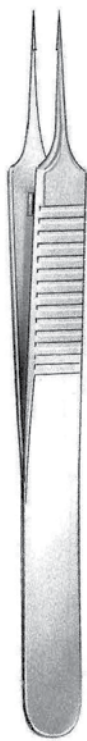

**Mod. Tübingen**  
**GD21.950.10**  
**GD21.954.10**  
10.0 cm

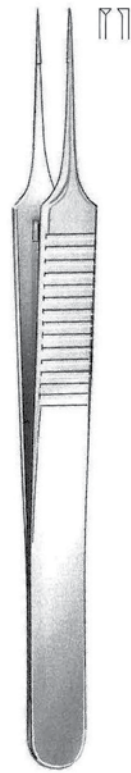

**Mod. Bonn**  
**GD21.952.10**  
**GD21.956.10**  
10.0 cm / 0.12 mm

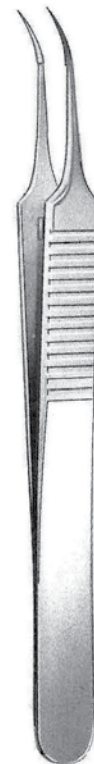

**Mod. Tübingen**  
**GD21.953.10**  
**GD21.957.10**  
10.0 cm



Ophthalmology  
Ophthalmologie  
Ophtalmologie  
Oftalmología  
Oftalmologia

**GRAND**  
DEVICES  
*The Grand Instruments Company*



**PRINCE**  
GD22.011.10  
10.0 cm

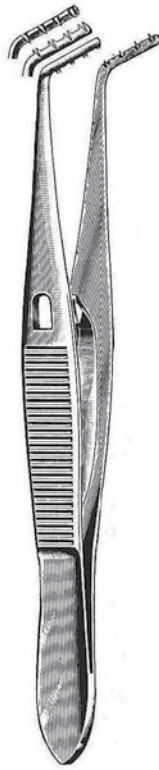

**PRINCE**  
GD22.013.10  
10.0 cm

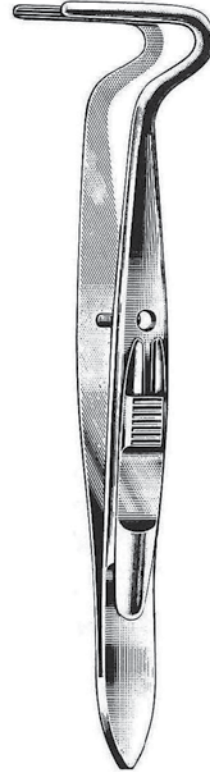

**BERKE**  
GD22.015.20 - GD22.015.27



GD22.015.20

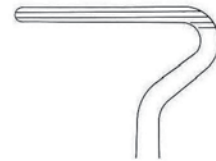

GD22.015.27

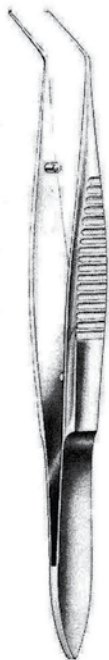

**TROUTMAN**  
GD22.017.08  
8.5 cm / 0.8 mm

Anterior Chamber Forceps  
Vorderkammer-Pinzette  
Pince à chambre antérieure  
Pinza para cámara anterior  
Pinza per camera anteriore

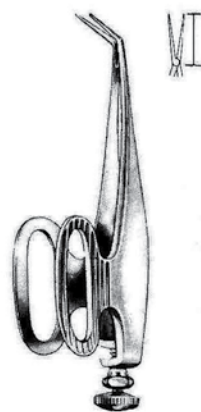

**BARRAQUER**  
GD22.021.05  
5.5 cm / 7 mm

Fixation Forceps, Capsular Forceps  
 Fixierpinzetten, Kapsel-Pinzetten  
 Pincas à fixation, Pincas capsulaires  
 Pinzas para fijación, Pinzas capsulares  
 Pinza per fissaggio, Pinze capsulare



**ELSCHNIG**  
 GD22.046.11  
 11.0 cm



**GRAEFE**  
 GD22.050.11 - GD22.052.11

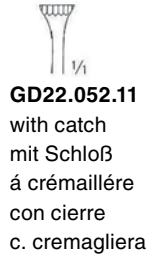

**LESTER**  
 GD22.054.09  
 9.0 cm



**CASTROVIEJO**  
 GD22.066.09

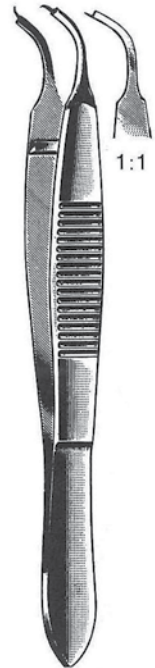

**CASTROVIEJO**  
 GD22.067.09



**CASTROVIEJO**  
 GD22.068.09



**CASTROVIEJO**  
 GD22.069.09



**BARRAQUER**  
 GD22.074.10  
 10.0 cm

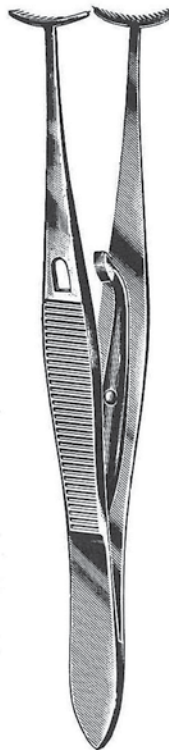

**GREEN**  
 GD22.076.05 - GD22.078.10  
 10.0 cm



**GD22.076.05**  
 5 mm  
 without / ohne / sans  
 sin/senza



**GD22.076.10**  
 10 mm



**GD22.078.05**  
 5 mm  
 with / mit / avec / con



**GD22.078.10**  
 10 mm

catch / Schloß /  
 crémaillère /cierre /  
 cremagliera

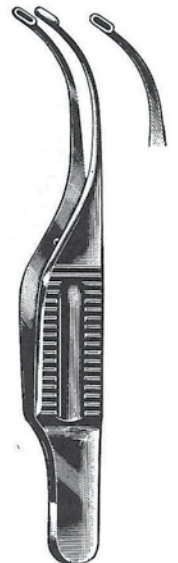

**GILL-ARRUGA**  
 GD22.101.07  
 7.5 cm





Capsular Forceps  
Kapsel-Pinzetten  
Pincas capsulaires  
Pinzas capsulares  
Pinze capsulare

**GRAND**  
DEVICES  
The Grand Instruments Company



**TERSON**  
GD22.103.09  
9.0 cm



**KALT**  
GD22.106.10  
10.0 cm



**ELSCHNIG**  
GD22.109.10  
10.0 cm

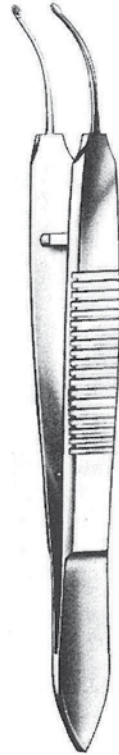

**ARRUGA**  
GD22.111.10  
10.0 cm

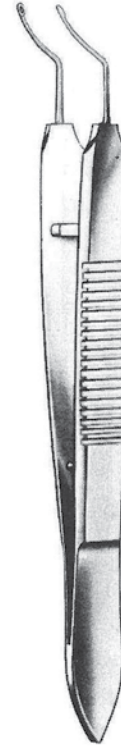

**ARRUGA**  
GD22.114.10  
10.0 cm

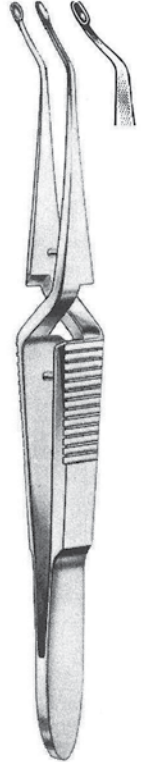

**CASTROVIEJO**  
GD22.115.10  
10.0 cm



**SCHWEIGGER**  
GD22.117.10  
10.0 cm



**SCHWEIGGER**  
GD22.119.10  
10.0 cm



**SCHWEIGGER**  
GD22.121.10  
10.0 cm



**HESS**  
GD22.125.06  
6.0 cm



**HESS**  
GD22.127.06  
6.5 cm



**FUCHS**  
GD22.129.07  
7.0 cm

Suturing, Ligature Forceps  
 Naht-, Faden-Pinzetten  
 Pincès à sutures et à ligature  
 Pinzas para suturas y para ligaduras  
 Pinze per sutura e per legatura



tooth  
 Zahn  
 dent  
 diente  
 dente

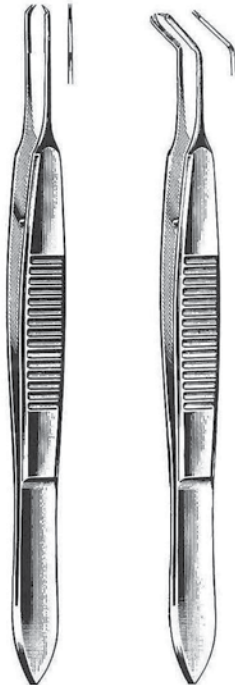

**CASTROVIEJO**

- 0.12 mm **GD22.150.01**
- 0.3 mm **GD22.150.03**
- 0.5 mm **GD22.150.05** **GD22.151.05**
- 1.0 mm **GD22.150.10** **GD22.151.10**
- 1.5 mm **GD22.150.15** **GD22.151.15**



**MOORFIELD**

- GD22.164.10**
- 10.0 cm



**St. MARTIN**

- GD22.166.07**
- 7.0 cm

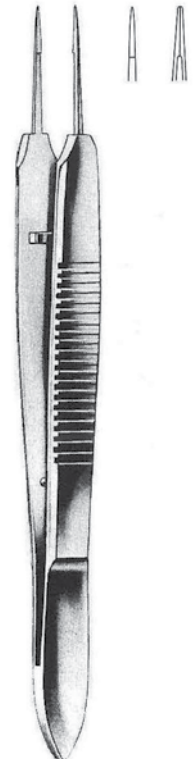

**Mod. Tübingen**

- GD22.181.10**
- GD22.185.10**
- 7.0 cm

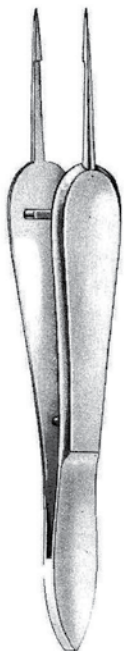

**PAUFIQUE**

- GD22.190.08**
- GD22.194.08**

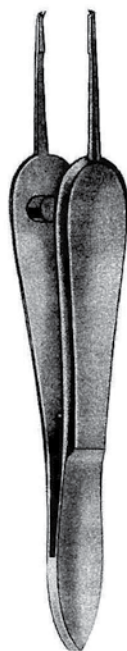

**PAUFIQUE**

- GD22.202.08**
- GD22.206.08**

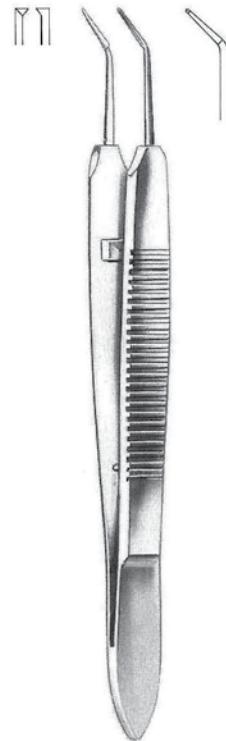

**McPHERSON**

- GD22.210.10**
- GD22.214.10**



**McPHERSON**

- GD22.220.10**
- GD22.224.10**



Forceps for Chalazio, Entropium, Trachoma  
Pinzetten für Chalazion, Entropium, Trachom  
Pincès à chalazion, à entropion, à granulations du trachome  
Pinzas de chalazión, de entropión y para tracoma  
Pinze per calazio, per entropio e per trichiasi

**GRAND**  
DEVICES  
*The Grand Instruments Company*



**AYER**  
**GD22.240.09**  
9.0 cm



**AYER**  
**GD22.242.09**  
9.0 cm



**LAMBERT**  
**GD22.246.09**  
9.0 cm



**DESMARRES**  
**GD22.254.09 - GD22.258.09**  
9.0 cm



**GD22.254.09**  
Fig. 1



**GD22.256.09**  
Fig. 2



**GD22.258.09**  
Fig. 3

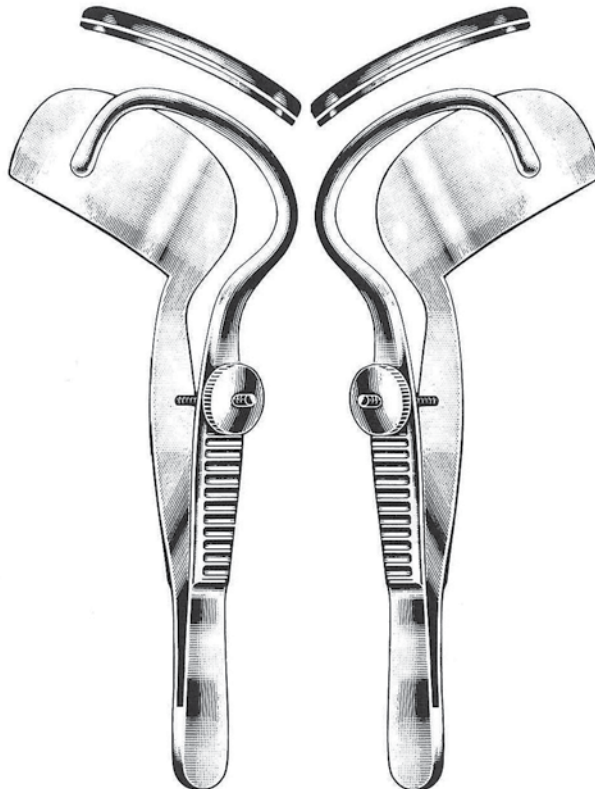

**SNELLEN**  
**GD22.265.10**  
10.0 cm

**SNELLEN**  
**GD22.267.10**  
10.0 cm

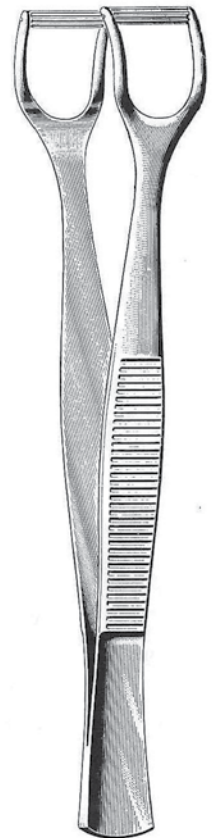

**KNAPP-LUER**  
**GD22.274.11**  
11.0 cm



**SCHEIE**  
**GD22.302.28**  
1.0 x 28 mm

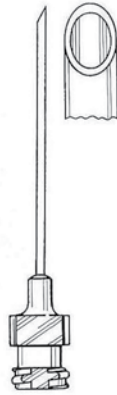

**SCHEIE**  
**GD22.302.33**  
1.5 x 33 mm



**Mod. Tübingen**  
**GD22.303.45**



**Mod. Hamburg**  
**GD22.305.00**

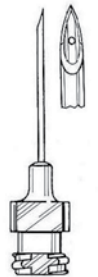

**SIMCOE**  
**GD22.306.00**



**Mod. Bonn**  
**GD22.307.00**



**Mod. Bonn**  
**GD22.309.00**

Corneal Trephines • Hornhaut-Trephinen  
Trépan cornéens • Trépanos corneales  
Trefine corneali

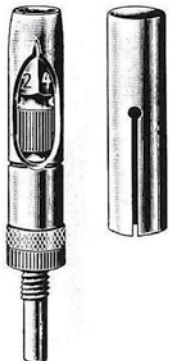

**CASTROVIEJO**  
**GD22.310.50 -**  
**GD22.311.01**

- CASTROVIEJO**
- |           |                    |
|-----------|--------------------|
| 5.0 ø mm  | <b>GD22.310.50</b> |
| 5.5 ø mm  | <b>GD22.310.55</b> |
| 6.0 ø mm  | <b>GD22.310.60</b> |
| 6.5 ø mm  | <b>GD22.310.65</b> |
| 7.0 ø mm  | <b>GD22.310.70</b> |
| 8.0 ø mm  | <b>GD22.310.80</b> |
| 9.0 ø mm  | <b>GD22.310.90</b> |
| 10.0 ø mm | <b>GD22.310.00</b> |
| 11.0 ø mm | <b>GD22.311.01</b> |



**FRANCESCHETTI**  
**GD22.320.50 - GD22.321.00**

**FRANCESCHETTI**

- |           |                    |
|-----------|--------------------|
| 5.0 ø mm  | <b>GD22.320.50</b> |
| 5.1 ø mm  | <b>GD22.320.51</b> |
| 6.0 ø mm  | <b>GD22.320.60</b> |
| 6.1 ø mm  | <b>GD22.320.61</b> |
| 7.0 ø mm  | <b>GD22.320.70</b> |
| 7.1 ø mm  | <b>GD22.320.71</b> |
| 8.0 ø mm  | <b>GD22.320.80</b> |
| 8.1 ø mm  | <b>GD22.320.81</b> |
| 9.0 ø mm  | <b>GD22.320.90</b> |
| 9.1 ø mm  | <b>GD22.320.91</b> |
| 10.0 ø mm | <b>GD22.321.00</b> |





Ophthalmology  
Ophthalmologie  
Ophtalmologie  
 Oftalmología  
 Oftalmologia

**GRAND**  
DEVICES  
The Grand Instruments Company

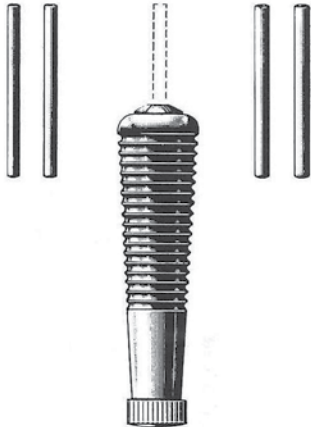

**ELLIOT**

**GD22.340.00**  
compl. = 4

Tonometer • Tonometro • Tonométre

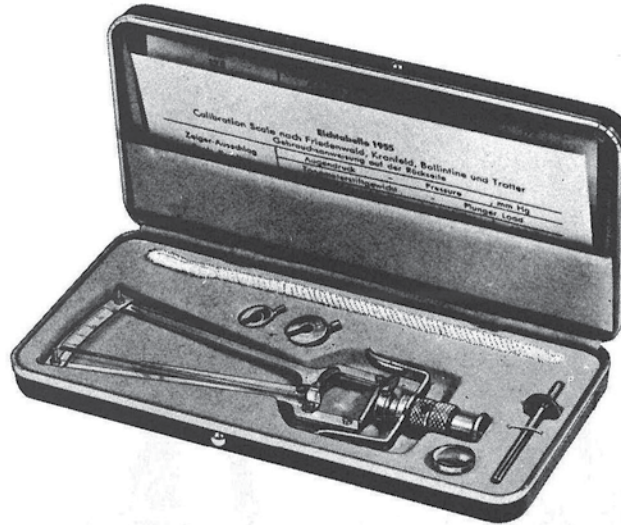

**SCHIOETZ**

**GD22.404.00 - GD22.406.00**

scale	straight	oblique
Skala	gerade	schräg
échelle	droite	oblique
escala	recta	oblicua
scala	retta	obliqua



**GD22.408.00**

Eye Magnet  
Augen-Magnet  
Aimant à corps étrangers Imán  
para cuerpos extráneos  
Calamita per corpi estranei

CiliaForceps • Cilien-Pinzetten  
Pinces à épiler les cils • Pinzas  
depilatorias • Pinze depilatorie

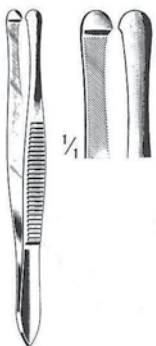

**BEER**

**GD22.420.09**  
9.0 cm

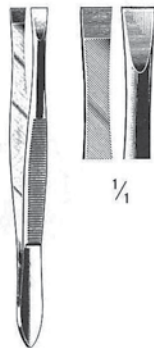

**DOUGLAS**

**GD22.422.09**  
9.0 cm

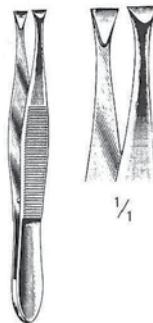

**LITTAUER**

**GD22.424.08**  
8.5 cm



**DBARRAQUER**

**GD22.425.10**  
10.5 cm

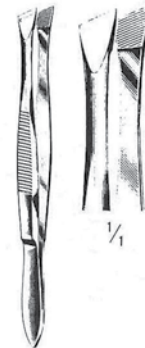

**GRADLE**

**GD22.428.09**  
9.5 cm

Otology  
Otologie  
Otologie  
Otología  
Otologia  
耳科



**GD**23



Ear Specula  
Ohr-Spekula  
Spéculums auriculaires  
Espéculos auriculares  
Specoli auricolari

**GRAND**  
DEVICES  
*The Grand Instruments Company*

① 3.0 mm Ø  
**GD23.010.30**

① 4.5 mm Ø  
**GD23.010.45**

② 5.5 mm Ø  
**GD23.010.55**

③ 6.5 mm Ø  
**GD23.010.65**

④ 7.5 mm Ø  
**GD23.010.75**



**HARTMANN**

Set = 4 **GD23.010.00**

② 5.5 mm Ø  
**GD23.012.55**

③ 6.5 mm Ø  
**GD23.012.65**

④ 7.5 mm Ø  
**GD23.012.75**



**TOYNBEE**

Set = 3 **GD23.012.00**

① 4.5 mm Ø  
**GD23.014.45**

② 5.5 mm Ø  
**GD23.014.55**

③ 6.5 mm Ø  
**GD23.014.65**

④ 7.5 mm Ø  
**GD23.014.75**



**GRUBER**

Set = 4 **GD23.014.00**

① 4.5 mm Ø  
**GD23.015.45**

② 5.5 mm Ø  
**GD23.015.55**

③ 6.5 mm Ø  
**GD23.015.65**

④ 7.5 mm Ø  
**GD23.015.75**



**GRUBER**

Set = 3 **GD23.015.00**



⑤ 5.0 mm  
**GD23.018.50**

⑥ 6.0 mm  
**GD23.018.60**

⑦ 7.0 mm  
**GD23.018.70**

⑧ 8.0 mm  
**GD23.018.80**

**BOUCHERON**

Set = 4 **GD23.018.00**

①  
6.5 mm Ø

②  
7.0 mm Ø

③  
8.0 mm Ø



**BRUENINGS**

Compl. **GD23.030.04**



**SIEGLE**

Compl. **GD23.036.03**

Tuning Forks  
Stimmgabeln  
Diapasons  
Diapasones  
Diapason



**GD23.060.01**  
C 128

**GD23.060.02**  
C<sup>1</sup> 256

**GD23.060.03**  
C<sup>2</sup> 512

**GD23.060.04**  
C<sup>3</sup> 1024

**GD23.060.05**  
C<sup>4</sup> 2048

ALU



ALU  
Compl. **GD23.061.00**



**GD23.070.01**  
C 128

**GD23.070.02**  
C<sup>1</sup> 256

**GD23.070.03**  
C<sup>2</sup> 512

**GD23.070.04**  
C<sup>3</sup> 1024

**GD23.070.05**  
C<sup>4</sup> 2048

HARTMANN



HARTMANN  
Compl. **GD23.071.00**





Tuning Forks  
Stimmgabeln  
Diapasons  
Diapasones  
Diapason

**GRAND**  
DEVICES  
*The Grand Instruments Company*

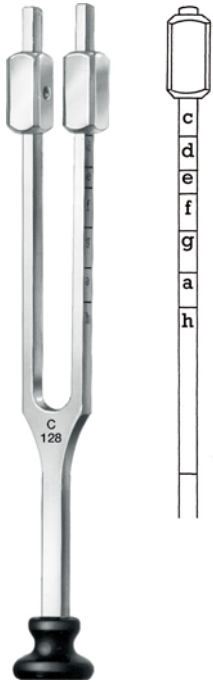

**LUCAE**

C 128 **GD23.074.01**



Neurol. **GD23.075.00**



**RYDEL-SEIFFER**

C64/C128 **GD23.076.01**

Noise Apparatus  
Lärmapparat  
Assourdisseur  
Ensordecedor  
Assordatore



**BARANY**

C64/C128 **GD23.080.00**

Powder Blowers  
Pulverbläser  
Lance-Poudre  
Lanzapolvo  
Insuffiadori per  
polvere



**KABIERSKE**

30 cc **GD23.090.00**



**KABIERSKE**

30 cc **GD23.090.01**

Air Bag, Ear Syringe  
 Luftdusche, Ohrspritze  
 Insufflateur d'air, Seringue  
 Insuflador de aire, Jeringa  
 Insoffiatore d'aria, Siringa



**POLITZER**

GD23.091.00 = GD23.091.15, GD23.091.17, GD23.091.22, GD23.091.03  
 GD23.091.01 = GD23.091.15, GD23.091.17, GD23.091.22, GD23.091.03, GD23.091.04



**REINER**

50 ml      **GD23.096.50**  
 75 ml      **GD23.096.75**  
 100 ml     **GD23.097.10**  
 150 ml     **GD23.097.15**



• Curettes • Küretten  
 • Curettes • Curetas • Curette

	Fig. 00	0	1	2	3	4	5
• blunt • stumpf mousses romas smusse	GD23.109.00	GD23.110.00	GD23.110.01	GD23.110.02	GD23.110.03	GD23.110.04	GD23.110.05
• sharp • scharf tranchantes cortantes taglianti	GD23.111.00	GD23.112.00	GD23.112.01	GD23.112.02	GD23.112.03	GD23.112.04	GD23.112.05
• blunt • stumpf mousses romas smusse	GD23.114.00	GD23.115.00	GD23.115.01	GD23.115.02	GD23.115.03	GD23.115.04	GD23.115.05
• sharp • scharf tranchantes cortantes taglianti	GD23.116.00	GD23.117.00	GD23.117.01	GD23.117.02	GD23.117.03	GD23.117.04	GD23.117.05



Catheters, Paracentesis Needles, Ear Knives, Ear Spoons  
 Katheter, Parazentesenadeln, Ohrmesser, Ohrlöffel  
 Sondes, Aiguilles à paracentèse, Couteaux auriculaires, Cuillers  
 Cateteres, Aguja para paracentesis, Cuchillos auriculares, Cucharas  
 Cateteri, Aghi per paracentesi, Coltelli auricolari, Cucchiali

**GRAND**  
 DEVICES  
 The Grand Instruments Company

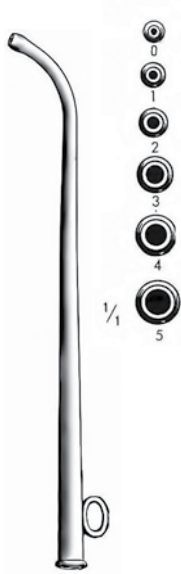

**HART MANN**

- Fig. 0 **GD23.131.00**
- Fig. 1 **GD23.131.01**
- Fig. 2 **GD23.131.02**
- Fig. 3 **GD23.131.03**
- Fig. 4 **GD23.131.04**
- Fig. 5 **GD23.131.05**

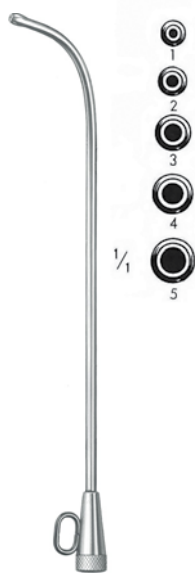

**ITARD**

- GD23.133.01**
- GD23.133.02**
- GD23.133.03**
- GD23.133.04**
- GD23.133.05**



**POLITZER**

18.0 cm **GD23.150.18**



**POLITZER**

16.5 cm **GD23.151.16**

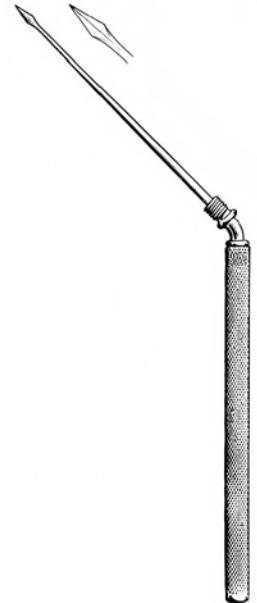

**POLITZER**

18.0 cm **GD23.153.16**



**POLITZER**

15.0 cm **GD23.160.15**



**SEXTON**

18.0 cm **GD23.162.18**



**SEXTON**

17.0 cm **GD23.164.17**



**SEXTON**

17.0 cm **GD23.165.17**



**GROSS**

12.0 cm **GD23.170.12**



**GROSS**

12.0 cm **GD23.171.12**

Loops, Hooklets, Dressing Forceps, Snares  
 Schlingen, Håkchen, Pinzetten, Schnürer  
 Anses, Crochets, Pincas, Serrenoed  
 Asas, Granchitos, Pinzas, Cierranudos  
 Anse, Uncinetti, Pinze, Serranodi



**BILLEAU**

**DAY**

**WAGENER**

**WILDE (TROELTSCH)**

GD23.180.01 - GD23.180.03    GD23.190.01 - GD23.190.02    GD23.192.01 - GD23.192.04

GD23.201.11 - GD23.203.11  
 12.0 cm

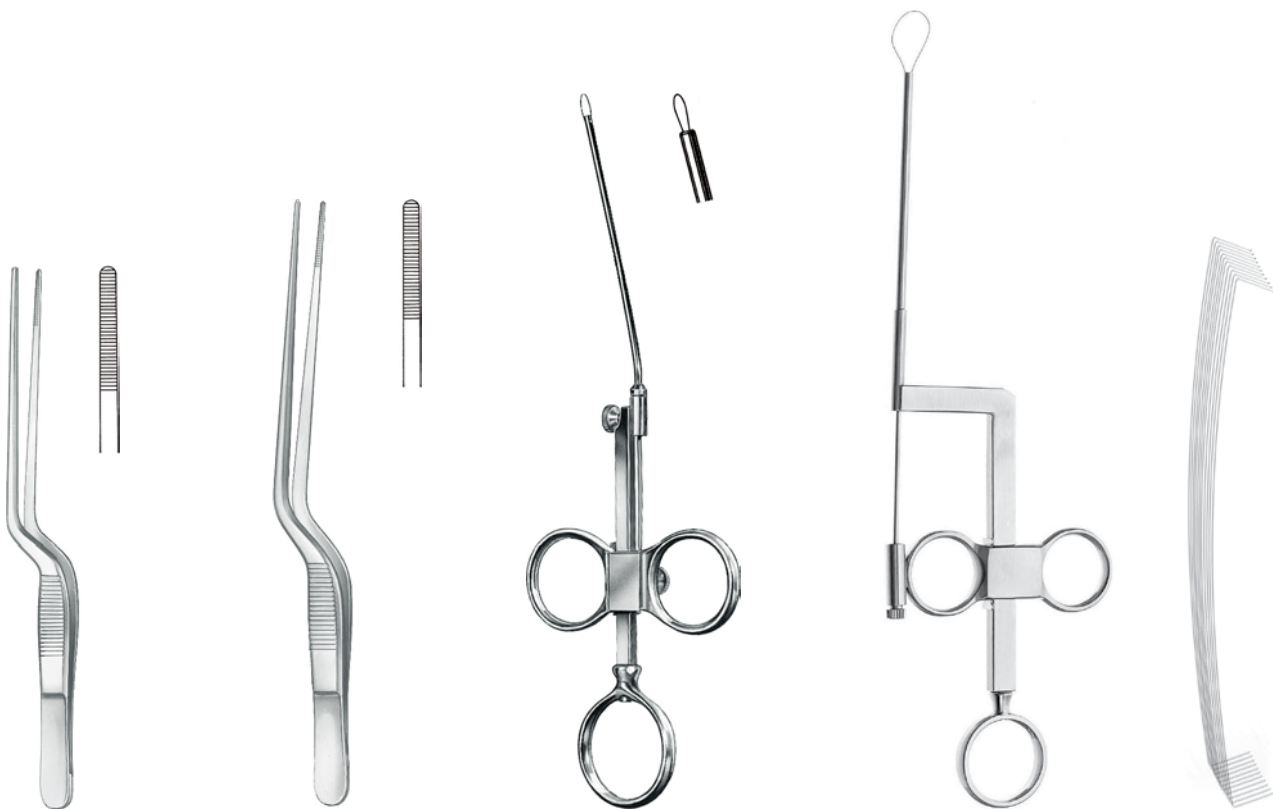

**LUCAE**

**LUCAE**

**KRAUSE**

**WILDE**

14.0 cm    **GD23.206.14**

16.0 cm    **GD23.206.16**

16.0 cm    **GD23.220.16**

17.0 cm    **GD23.222.17**

**GD23.225.02**  
 Dtzd./doz./douz/  
 doc./dozz.



Ear Forceps  
Ohrzängchen  
Pincés auriculaires  
Pinzas auriculares  
Pinze auricolari

**GRAND**  
DEVICES  
The Grand Instruments Company



**TILLEY**  
14.0 cm **GD23.243.14**



**LITTAUER**  
12.0 cm **GD23.245.12**



**HARTMANN**  
12.0 cm **GD23.241.12**



**HARTMANN**  
14.0 cm **GD23.241.14**



**QUIRE**  
10.0 cm **GD23.251.10**

Foreign Body Levers  
Fremdkörperhebel  
Leviers pour corps étrangers  
Elevadores para cuerpos extranjeros  
Leve per corpi estranei



**BUCK**  
11.0 cm **GD23.253.11**



**GD23.255.08 - GD23.275.08**



**HARTMANN-WULLSTEIN**  
8.50 cm **GD23.255.08**



**HARTMANN-WULLSTEIN**  
8.50 cm **GD23.257.08**



**HARTMANN**  
8.50 cm **GD23.261.08**  
14.0 cm **GD23.261.14**  
16.0 cm **GD23.261.16**



**HARTMANN**  
8.50 cm **GD23.263.08**  
14.0 cm **GD23.263.14**



**HARTMANN**  
8.50 cm **GD23.265.08**



**HARTMANN**  
2.0 cm **GD23.267.20**  
2.5 cm **GD23.267.25**  
3.0 cm **GD23.267.30**  
8.50 cm



**HARTMANN**  
8.50 cm **GD23.269.30**



**STRUEMPEL**  
8.50 cm **GD23.271.08**



**HARTMANN**  
8.50 cm **GD23.273.08**



**HARTMANN-HOFFMANN**  
8.50 cm **GD23.275.08**



Micro Ear Scissors  
Mikro-Ohrscherchen  
Ciseaux auriculaires micro  
Tijeras auriculares micro  
Forbici auricolari micro



**GD23.310.40 - GD23.322.70**

straight  
gerade  
droite  
recta  
retta



**BELLUCCI**

4.0 mm **GD23.310.40**

straight  
gerade  
droite  
recta  
retta



**BELLUCCI**

5.5 mm **GD23.312.55**

bent upwards  
aufgebogen  
courbée vers le haut  
curva por arriba  
curva in alto



**BELLUCCI**

5.5 mm **GD23.313.55**

right  
rechts  
droite  
derecha  
retta



**BELLUCCI**

5.5 mm **GD23.315.55**



**BELLUCCI**

5.5 mm **GD23.317.55**

straight  
gerade  
droite  
recta  
retta



**SHEA**

7.0 mm **GD23.320.70**

left  
links  
gauche  
izquierda  
sinistra



**SHEA**

7.0 mm **GD23.321.70**

right  
rechts  
droite  
derecha  
retta



**SHEA**

7.0 mm **GD23.322.70**

serrated, straight  
gerieft, gerade  
striée, droite  
estriada, recta  
con scanalatura,  
retta



4.0 mm **GD23.350.40**

serrated, straight  
gerieft, gerade  
striée, droite  
estriada, recta  
con scanalatura,  
retta



7.0 mm **GD23.350.70**

smooth, straight  
glatt, gerade  
lisse, droite  
lisa, recta  
liscia, retta



4.0 mm **GD23.352.40**

Micro Ear Forceps  
Mikro-Ohrzängchen  
Pinces auriculaires micro  
Pinzas auriculares micro  
Pinze auricolari micro



**GD23.350.40 - GD23.360.35**

left, serrated  
links, gerieft  
gauche, striée  
izquierda, estriada  
sinistra, con scanalatura



6.0 mm **GD23.353.60**

right, serrated  
rechts, gerieft  
droite, striée  
derecha, estriada  
retta, con scanalatura



6.0 mm **GD23.355.60**

bent upwards, serrated  
aufgebogen, gerieft  
courbée vers le haut, striée  
curva por arriba, estriada  
curva in alto, con scanalatura



4.0 mm **GD23.357.40**

downwards, serrated  
abwärts gebogen, gerieft  
courbée en bas, striée  
curva hacia abajo,  
estriada curva in basso,  
con scanalatura



4.0 mm **GD23.359.40**

serrated, straight  
gerieft, gerade  
striée, droite  
estriada, recta  
con scanalatura,  
retta



3.5 mm **GD23.360.35**



**Micro Ear Forceps**  
**Mikro-Ohrzängchen**  
**Pinces auriculaires micro**  
**Pinzas auriculares micro**  
**Pinze auricolari micro**



right  
rechts  
droite  
derecha  
retta



4.5 mm **GD23.362.45**



5.0 mm **GD23.367.50**

left  
links  
gauche  
izquierda  
sinistra



4.5 mm **GD23.363.45**



5.0 mm **GD23.369.50**

straight  
gerade  
droite  
recta  
retta



4.5 mm **GD23.365.45**

bent downwards  
abgebogen  
courbée vers le bas  
curva por abajo  
curva in basso



**MCGEE**

0.8 x 3.5 mm **GD23.370.50**

bent downwards  
abgebogen  
courbée vers le bas  
curva por abajo  
curva in basso



**MCGEE**

0.8 x 6.0 mm **GD23.371.40**



**GD23.362.45 - GD23.371.40**



**DIETER**

**GD23.385.01 - GD23.387.02**

Malleus Nippers  
 Hammerkopf-Zwickzängchen  
 Pinces pour la tête du marteau  
 Pinzas para la cabeza del martillo  
 Pinze per la testa del martello

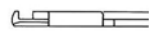

micro **GD23.385.01**



micro **GD23.385.02**

upward  
aufwärts  
en haut  
arriba  
inalto

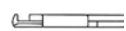

mini **GD23.387.01**



mini **GD23.387.02**

downward  
abwärts  
en bas  
abajo  
in basso



Micro Ear Forceps  
Mikro-Ohrzängchen  
Pinces auriculaires micro  
Pinzas auriculares micro  
Pinze auricolari micro



Ring Handle Patterns  
Modelle mit Ringgriff  
Modèles manches à anneaux  
Modelos mangos con anillos  
Modelli manici con anelli

Pencil Handle Patterns  
Modelle mit Bleistiftgriff  
Modèles manches crayon  
Modelos mango en forma de lapiz  
Modelli manico forma matita

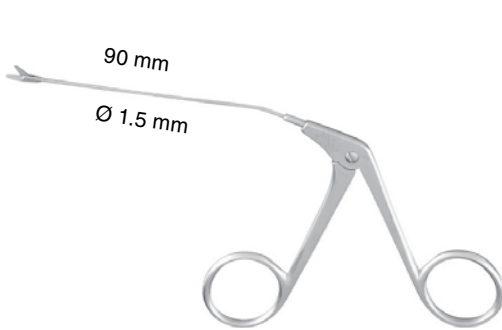

**GD23.410.00 - GD23.419.00**  
micro  
RG

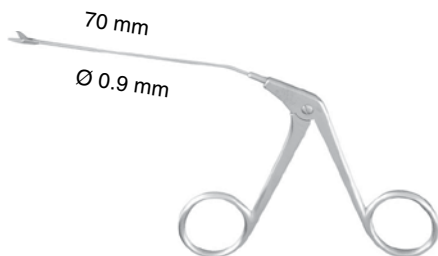

**GD23.420.00 - GD23.429.00**  
micro-mini  
RG

**GD23.410.00**  **GD23.430.00**

**GD23.412.00**  **GD23.432.00**

**GD23.413.00**  **GD23.433.00**

**GD23.415.00**  **GD23.435.00**

**GD23.417.00**  **GD23.437.00**

**GD23.419.00**  **GD23.439.00**

 **GD23.439.08**

**GD23.420.00**  **GD23.440.00**

**GD23.422.00**  **GD23.442.00**

**GD23.423.00**  **GD23.443.00**

**GD23.425.00**  **GD23.445.00**

**GD23.427.00**  **GD23.447.00**

**GD23.429.00**  **GD23.449.00**

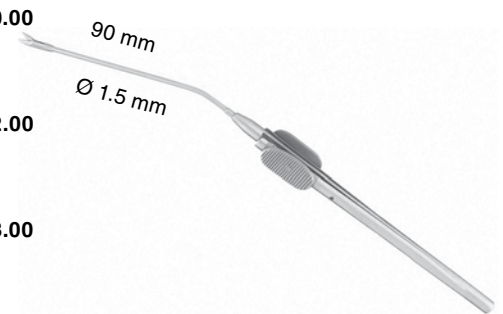

**GD23.430.00 - GD23.439.08**  
micro  
RG

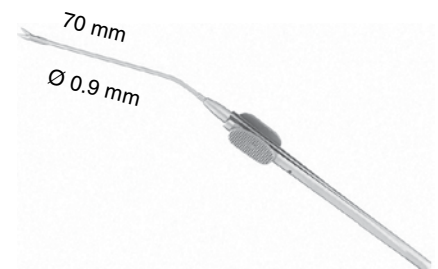

**GD23.440.00 - GD23.449.08**  
micro-mini  
RG



**Micro Ear Forceps**  
**Mikro-Ohrzängchen**  
**Pinces auriculaires micro**  
**Pinzas auriculares micro**  
**Pinze auricolari micro**



Ring Handle Patterns  
 Modelle mit Ringgriff  
 Modèles manches à anneaux  
 Modelos mangos con anillos  
 Modelli manici con anelli



Pencil Handle Patterns  
 Modelle mit Bleistiftgriff  
 Modèles manches crayon  
 Modelos mango en forma de lapiz  
 Modelli manico forma matita

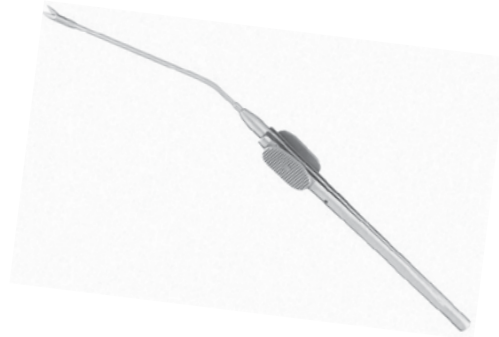

**GD23.510.00 - GD23.549.00**  
 micro  
 RG

**GD23.510.00**



**GD23.610.00**

**GD23.610.00 - GD23.649.00**  
 micro  
 RG

**GD23.511.00**



**GD23.611.00**

**GD23.513.00**



**GD23.613.00**

**GD23.514.00**



**GD23.614.00**

**GD23.515.00**



**GD23.615.00**

**GD23.516.00**



**GD23.616.00**

**GD23.517.00**



**GD23.617.00**

**GD23.519.00**



**GD23.619.00**

**GD23.520.00**



**GD23.620.00**

**GD23.521.00**



Ø 1.0 mm    Ø 1.5 mm    Ø 2.0 mm    Ø 2.5 mm

**GD23.522.00**    **GD23.528.00**    **GD23.534.00**    **GD23.540.00**

**GD23.523.00**    **GD23.529.00**    **GD23.535.00**    **GD23.541.00**

**GD23.525.00**    **GD23.531.00**    **GD23.537.00**    **GD23.543.00**

**GD23.527.00**    **GD23.533.00**    **GD23.539.00**    **GD23.545.00**

**GD23.546.00**



Ø 1.0 mm    Ø 1.5 mm    Ø 2.0 mm    Ø 2.5 mm

**GD23.622.00**    **GD23.628.00**    **GD23.634.00**    **GD23.640.00**

**GD23.623.00**    **GD23.629.00**    **GD23.635.00**    **GD23.641.00**

**GD23.625.00**    **GD23.631.00**    **GD23.637.00**    **GD23.643.00**

**GD23.627.00**    **GD23.633.00**    **GD23.939.00**    **GD23.645.00**

**GD23.547.00**



**GD23.646.00**

**GD23.548.00**



**GD23.647.00**

**GD23.549.00**



**GD23.648.00**

Micro Ear Forceps  
 Mikro-Ohrzängchen  
 Pincès auriculaires micro  
 Pinzas auriculares micro  
 Pinze auricolari micro



Ring Handle Patterns  
 Modelle mit Ringgriff  
 Modèles manches à anneaux  
 Modelos mangos con anillos  
 Modelli manici con anelli



**GD23.550.00 - GD23.589.00**  
 micro-mini  
 RG

Pencil Handle Patterns  
 Modelle mit Bleistiftgriff  
 Modèles manches crayon  
 Modelos mango en forma de lapiz  
 Modelli manico forma matita

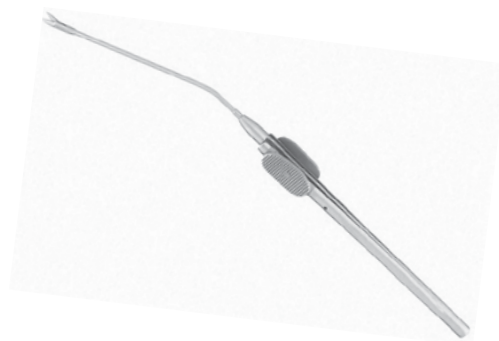

**GD23.650.00 - GD23.689.00**  
 micro-mini  
 RG

GD23.550.00		GD23.650.00
GD23.551.00		GD23.651.00
GD23.553.00		GD23.653.00
GD23.554.00		GD23.654.00
GD23.555.00		GD23.655.00
GD23.556.00		
GD23.557.00		GD23.657.00
GD23.559.00		GD23.659.00
GD23.560.00		GD23.660.00
GD23.561.00		
GD23.562.00		GD23.662.00
GD23.563.00		GD23.663.00
GD23.565.00		GD23.665.00
GD23.567.00		GD23.667.00
GD23.586.00		GD23.686.00
GD23.587.00		GD23.687.00
GD23.588.00		GD23.688.00
GD23.589.00		GD23.689.00



Otologie  
 Otology  
 Otologie  
 Otología  
 Otologia

**GRAND**  
 DEVICES  
*The Grand Instruments Company*



SCHUKNECHT  
 GD23.701.01



SCHUKNECHT  
 GD23.701.02



SCHUKNECHT  
 15.5 cm GD23.703.15



WULLSTEIN  
 15.5 cm GD23.704.15



TABB  
 15.5 cm GD23.705.15



PLESTER  
 15.5 cm / 3.5 mm Ø GD23.706.35

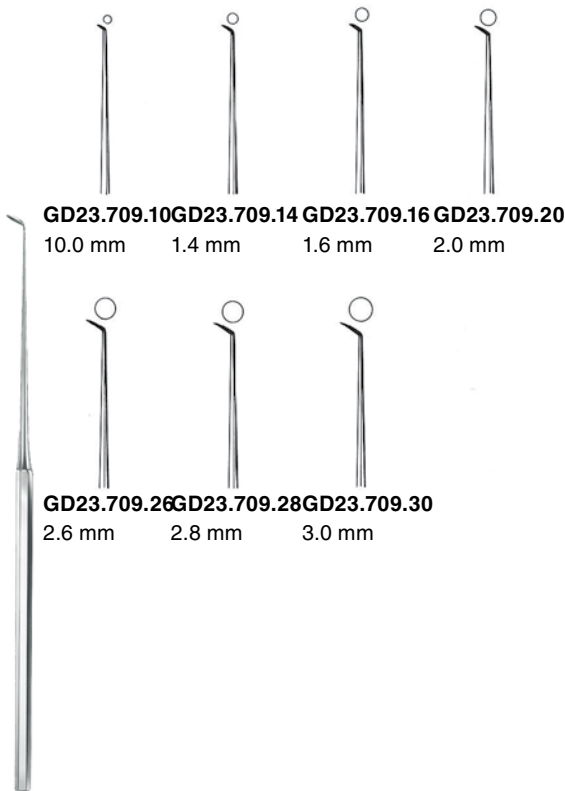

GD23.709.10 GD23.709.14 GD23.709.16 GD23.709.20  
 10.0 mm 1.4 mm 1.6 mm 2.0 mm

GD23.709.26 GD23.709.28 GD23.709.30  
 2.6 mm 2.8 mm 3.0 mm

ROSEN

GD23.709.10 - GD23.709.30

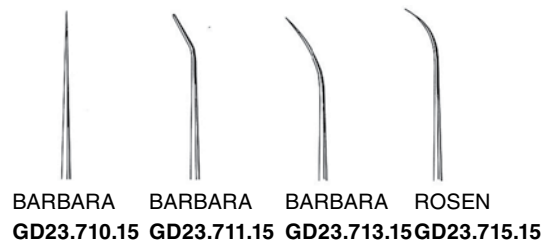

BARBARA BARBARA BARBARA ROSEN  
 GD23.710.15 GD23.711.15 GD23.713.15 GD23.715.15



	25°	45°	90°	
BARBARA	BARBARA	BARBARA	BARBARA	
0.3 mm	GD23.720.03	GD23.722.03	GD23.724.03	GD23.725.05 = 0.5 mm
0.6 mm	GD23.720.06	GD23.722.06	GD23.724.06	GD23.725.10 = 0.5 mm
1.0 mm	GD23.720.10	GD23.722.10	GD23.724.10	
1.2 mm		GD23.722.12	GD23.724.12	
1.5 mm		GD23.722.15	GD23.724.15	
2.0 mm		GD23.722.20	GD23.724.20	
2.5 mm		GD23.722.25	GD23.724.25	

BARBARA

GD23.710.15 - GD23.725.10



90° 90°

0.3 mm **GD23.730.03 GD23.732.03** 0.5 mm **GD23.733.05 GD23.735.05** 15.5 cm **GD23.736.15**  
 0.6 mm **GD23.730.06 GD23.732.06** 1.0 mm **GD23.733.10 GD23.735.10**

McGEE McGEE BARBARA

**GD23.751.16 GD23.753.16**

**GD23.755.16 GD23.757.16**

ROSEN

25° 45° 45° 45°

15.5 cm **GD23.737.15**

0.3 mm **GD23.741.03 GD23.743.03 GD23.745.03 GD23.747.03**  
 0.6 mm **GD23.741.06 GD23.743.06 GD23.745.06 GD23.747.06**  
 1.0 mm **GD23.741.10 GD23.743.10 GD23.745.10 GD23.747.10**

FISCH

**GD23.751.16 - GD23.757.16**

$\frac{1}{4}$  **GD23.802.16**  
2.0 mm

**GD23.803.16**  
2.0 mm

**GD23.805.16**  
3.0 mm

1.0/1.2 mm **GD23.760.01**  
1.5/1.8 mm **GD23.760.02**

1.0/1.2 mm **GD23.762.01**  
1.5/1.8 mm **GD23.762.02**

**GD23.766.35**  
3.5 mm

**GD23.766.40**  
4.0 mm

**GD23.766.45**  
4.5 mm

**GD23.766.50**  
5.0 mm

$\frac{1}{4}$

**MUCK**  
13.0 cm **GD23.812.13**

LEMPERT  
**GD23.802.16 -**  
**GD23.805.16**

HOUSE  
**GD23.760.01 -**  
**GD23.762.02**

HOUSE  
**GD23.766.35 -**  
**GD23.766.50**

LEMPERT  
 20.5 cm **GD23.807.20**

PASSOW  
 2x2 mm **GD23.810.02**  
 3x3 mm **GD23.810.03**



Mouth and Tongue  
Mund und Zunge  
Bouche et langue  
Boca y lengua  
Bocca e lingua  
口舌

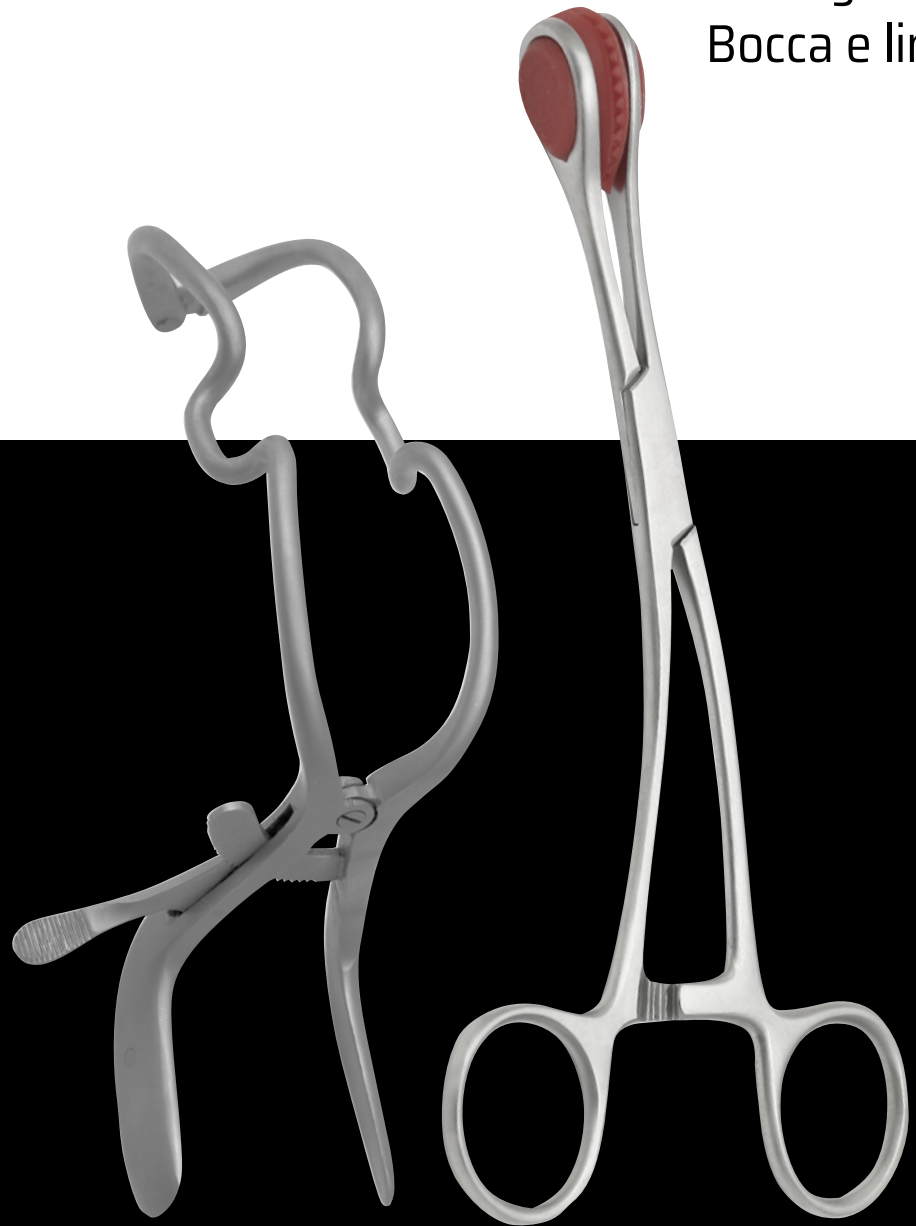

**GD**24





Tongue Depressors, Lip Retractors  
 Zungenspatel, Lippenhalter  
 Abaisse-langue, écarteurs des lèvres  
 Abajalengua, Separadores de labios  
 Abbassalingua, Divaricatori di labbra

**GRAND**  
 DEVICES  
 The Grand Instruments Company



**GD24.102.16**  
 wood • Holz • bois •  
 madera • legno  
 16 cm



**FRENZEL**  
 16.5 cm **GD24.105.16**



**BRUENINGS**  
 19.0 cm **GD24.107.19**



**BUCHWALD**  
 19.0 cm **GD24.109.19**



**HARTMANN**  
 15.0 cm **GD24.111.15**



**WIEDER**  
 14.0 cm **GD24.115.01** Fig. 1  
**WIEDER**  
 15.0 cm **GD24.115.02** Fig. 2



**ANDREW**  
 11.0 cm **GD24.117.11**



**TOBOLD**  
 14.5 cm **GD24.119.14**

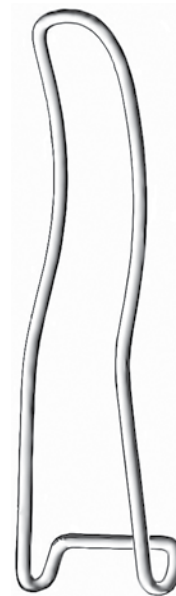

**STERNBERG**  
 14.0 cm **GD24.227.14**  
 16.0 cm **GD24.227.16**  
 18.0 cm **GD24.227.18**



**STERNBERG**  
 12.0 cm **GD24.229.12**  
 14.0 cm **GD24.229.14**  
 16.0 cm **GD24.229.16**

Mouth and Tongue  
Mund und Zunge  
Bouche et langue  
Boca y lengua  
Bocca e lingua



Tongue Holding Forceps • Zungenzangen  
Pinces tire-langue • Pinzas tiralengua  
Pinze tiralingua



**GD24.255.99**  
Spare (Pair)  
Ersatz (Paar)  
Rechange (paire)  
Repuesto (pareja)  
Ricambio (coppia)



11.0 cm **GD24.230.11**



19.0 cm **GD24.235.19**



**COLLIN**

16.0 cm **GD24.250.16**  
18.0 cm **GD24.250.18**



**YOUNG**

16.0 cm **GD24.255.16**



**DOYEN-JANSEN (MOLT)**  
12.0 cm **GD24.265.12**



**DOYEN-JANSEN (MOLT)**  
14.0 cm **GD24.265.14**



**DENHART**  
12.0 cm **GD24.267.12**



**ROSER-KOENIG**  
16.0 cm **GD24.270.16**  
19.0 cm **GD24.270.19**



**HEISTER**  
13.0 cm **GD24.272.13**



Mouth Gags  
Mundsperrer  
Ouvre-bouche  
Abrebocas  
Apribocca

**GRAND**  
DEVICES  
The Grand Instruments Company



**JENNINGS**

- 9.0 cm **GD24.274.09**
- 11.0 cm **GD24.274.11**
- 13.0 cm **GD24.274.13**
- 15.0 cm **GD24.274.15**

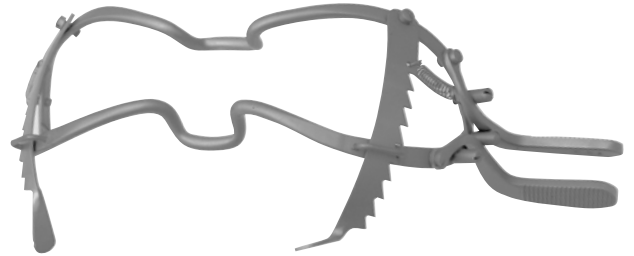

**WHITEHEAD**

- 11.0 cm **GD24.280.11**
- 13.0 cm **GD24.280.13**
- 15.0 cm **GD24.280.15**

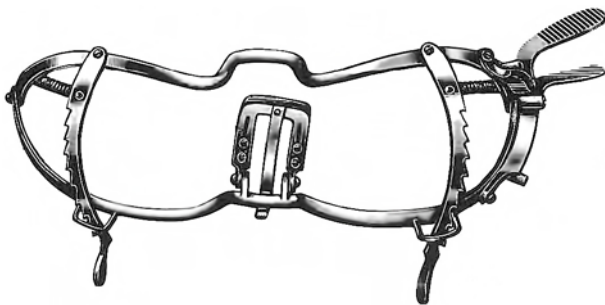

**WHITEHEAD**

- 11.0 cm **GD24.281.11**
- 13.0 cm **GD24.281.13**
- 15.0 cm **GD24.281.15**

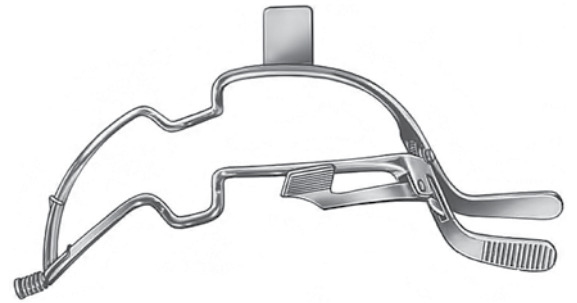

**SEEMANN-SEIFFERT**

- 9.0 cm **GD24.285.09**
- 11.0 cm **GD24.285.11**
- 13.0 cm **GD24.285.13**
- 15.0 cm **GD24.285.15**



**GD24.310.10**

**GD24.310.01**  
27 x 105 mm Fig.1

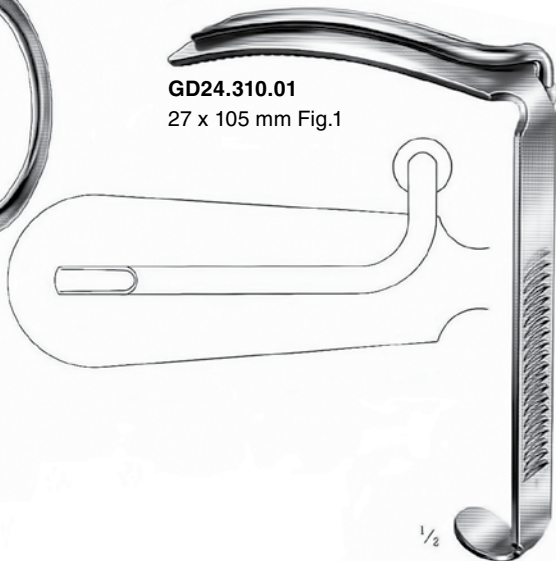

1/2

**DAVIS-BOYLE**

compl. **GD24.310.00**



1/2

**GD24.310.02**  
25 x 90 mm Fig.2



**GD24.310.03**  
25 x 75 mm Fig.3



1/2

**GD24.310.04**  
22 x 60 mm Fig.4



**GD24.310.05**  
20 x 25 mm Fig.5



GD24.315.10



GD24.315.01  
 28 x 65 mm Fig.1



GD24.315.02  
 32 x 75 mm Fig.2



GD24.315.03  
 37 x 80 mm Fig.3



GD24.315.99

KILNER-DOUGHTY  
 compl. GD24.315.00



GD24.320.10



GD24.320.01  
 27 x 95 mm Fig.1

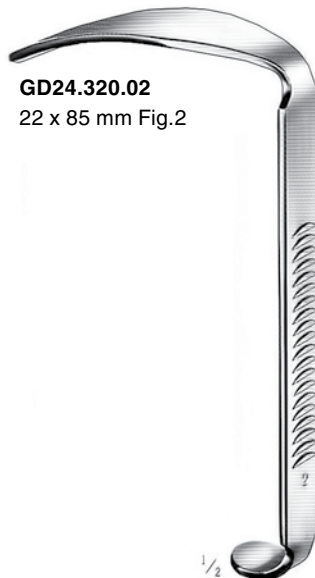

GD24.320.02  
 22 x 85 mm Fig.2

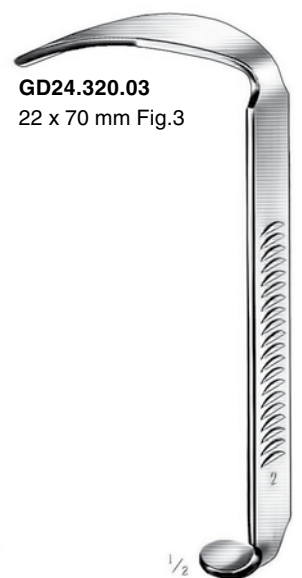

GD24.320.03  
 22 x 70 mm Fig.3

McIVOR

compl. GD24.320.00





Mouth  
Mund  
Bouche  
Boca  
Bocca

**GRAND**  
DEVICES  
*The Grand Instruments Company*



**MAUNDER**  
GD24.360.10



**PITHA**  
GD24.365.10



**LANGENBECK**  
GD24.371.01 Fig.1  
GD24.371.02 Fig.2  
GD24.371.03 Fig.3



left side  
links  
côté gauche  
izquierda  
lato sinistro



**ROWE**

22.5 cm **GD24.501.22**  
23.5 cm **GD24.501.23**  
24.0 cm **GD24.501.24**



right side rechts  
côte droit  
derecha  
lato destro

**ROWE**

22.5 cm **GD24.503.22** baby • Säugling • bébé • bebé • lattante  
23.5 cm **GD24.503.23** child • Kinder • enfant • niño • bambino  
24.0 cm **GD24.503.24** adult • Erwachsene

Rhinology  
Rhinologie  
Rhinologie  
Rinología  
Rinologia  
鼻科

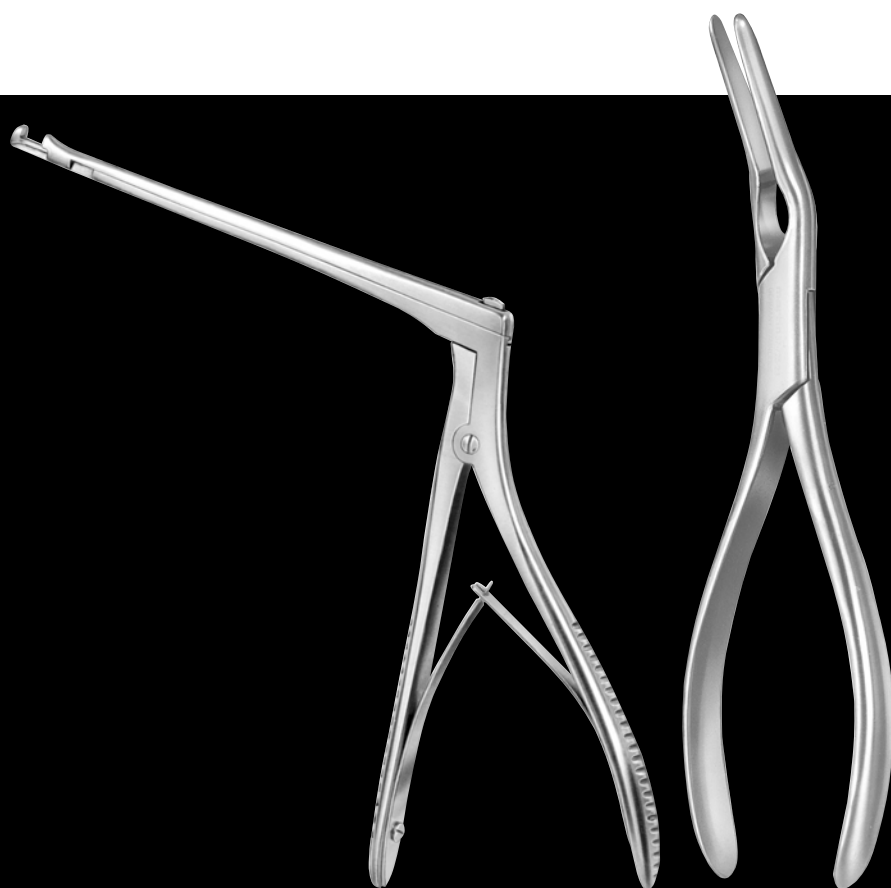

**GD**25



Nasal Specula  
 Nasenspekula  
 Spéculums nasaux  
 Espéculos nasales  
 Specoli nasali

**GRAND**  
 DEVICES  
 The Grand Instruments Company

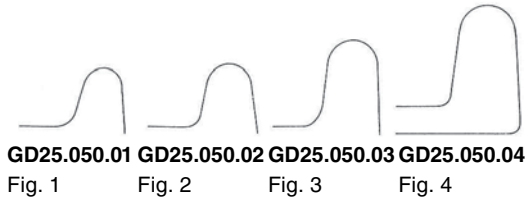

GD25.050.01 GD25.050.02 GD25.050.03 GD25.050.04  
 Fig. 1 Fig. 2 Fig. 3 Fig. 4

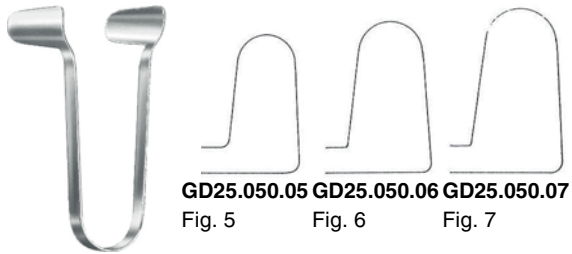

GD25.050.05 GD25.050.06 GD25.050.07  
 Fig. 5 Fig. 6 Fig. 7

THUDICHUM

GD25.050.01 - GD25.050.07



VOLTOLINI

GD25.060.01 - GD25.060.03

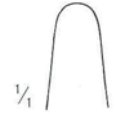

GD25.060.01  
 Fig. 1



GD25.060.02  
 Fig. 2



GD25.060.03  
 Fig. 3



HARTMANN-HALLE

GD25.102.01 - GD25.102.03  
 15.0 cm

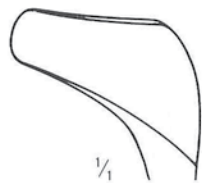

GD25.102.01  
 Fig. 1

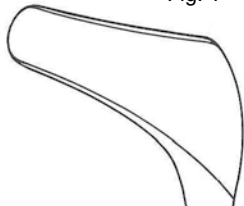

GD25.102.02  
 Fig. 2

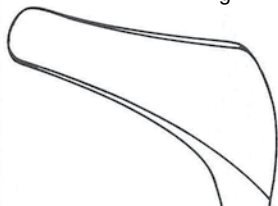

GD25.102.03  
 Fig. 3

MOD. WIEN • VIENNA • VIENNE • VIENA

Baby • Bébé  
 Child • Kind • enf • niño • bamb  
 Adult • Erw.



GD25.112.01  
 GD25.112.02  
 GD25.112.03

WIEN • MOD. • VIENNA VIENNE • VIENA

lightweight  
 leichtes Modell  
 mod. léger  
 mod. ligero  
 mod. leggero



GD25.113.03



Nasal Specula  
 Nasenspekula  
 Spéculums nasaux  
 Espéculos nasales  
 Specoli nasali



**TIECK-HALLE**  
 13.5 cm **GD25.116.13**



**KILLIAN**  
**GD25.120.35 - GD25.120.90**  
 13.0 cm

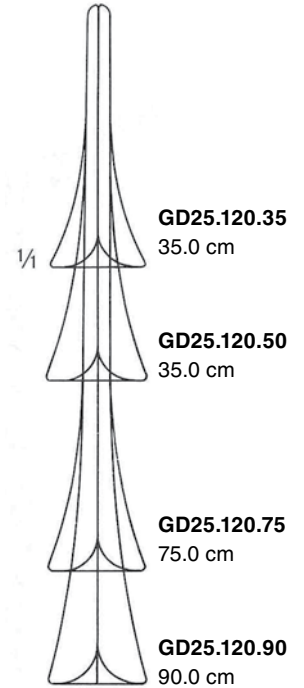

**COTTLE**  
**GD25.124.35 - GD25.124.90**  
 14.0 cm



**COTTLE**  
**GD25.126.35 - GD25.126.90**  
 schwarz • black • noirs  
 negros • neri  
 14 cm

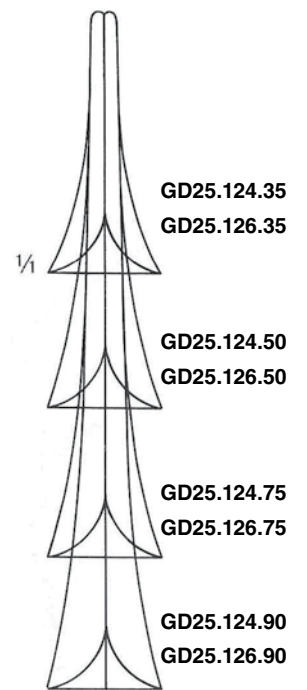



Rhinology  
 Rhinologie  
 Rhinologie  
 Rinología  
 Rinologia

**GRAND**  
 DEVICES  
*The Grand Instruments Company*



**YANKAUER**  
 19.0 cm **GD25.131.19**



**MICHEL**  
**GD25.139.12 - GD25.139.18**  
 25.0 cm



**TROELTSCH**  
 15.0 cm **GD25.151.15**

**TROELTSCH**  
 18.0 cm **GD25.151.18**



**JANSEN**  
 20.0 cm **GD25.154.20**



**HARTMANN**  
 16.0 cm **GD25.161.16**

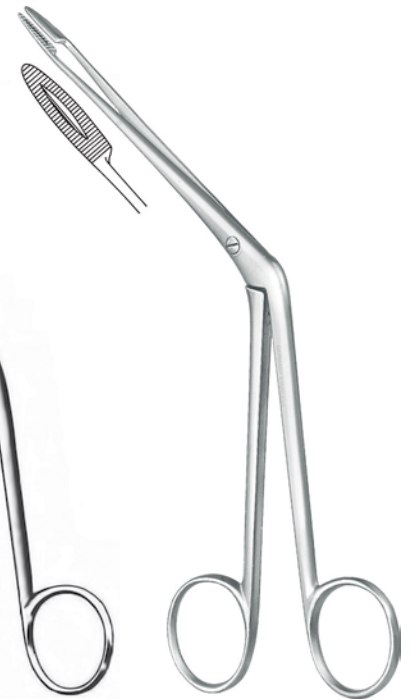

**HARTMANN**  
 20.0 cm **GD25.161.20**

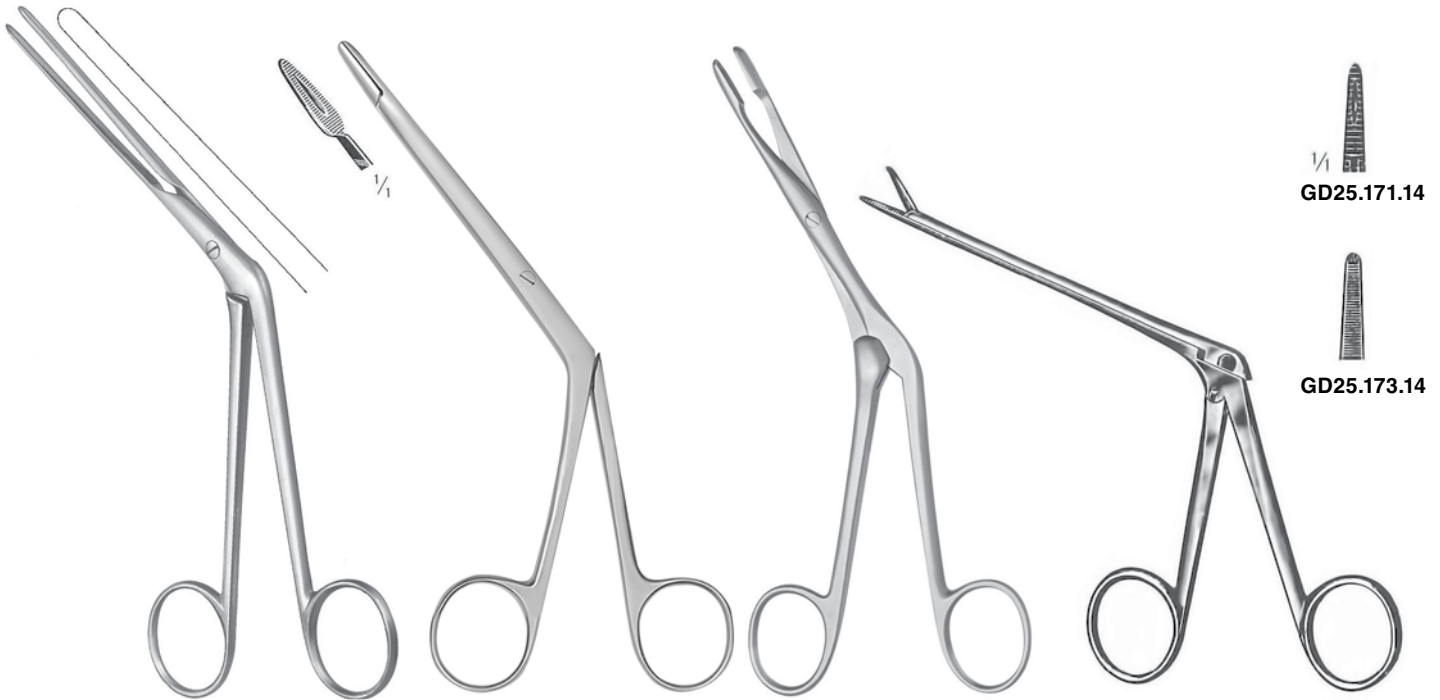

**LUBET-BARBON**  
20.0 cm **GD25.165.20**

**LITTAUER**  
18.0 cm **GD25.167.18**

**HEYMANN-KNIGHT**  
18.0 cm **GD25.169.18**

**NOYES**  
**GD25.171.14 - GD25.173.14**  
14.5 cm



**GD25.181.01** **GD25.181.02** **GD25.181.03**

**HEYMANN**  
**GD25.181.01 - GD25.181.03**  
18.0 cm

**KNIGHT**  
18.0 cm **GD25.185.18**

**BRUENINGS**  
**GD25.191.01 - GD25.191.04**  
19.0 cm



Nasal Cutting Forceps  
 Scharfe Nasenzangen  
 Pincés coupantes nasales  
 Pinzas cortantes nasales  
 Pinze taglianti nasali

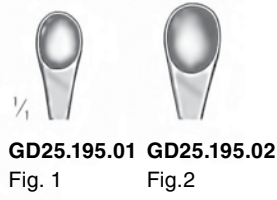

**GD25.195.01 - GD25.195.02**  
 19.0 cm  
**LUC**

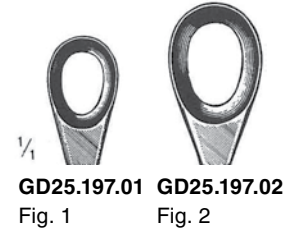

**GD25.197.01 - GD25.197.02**  
 19.0 cm  
**LUC**

without neck  
 ohne Hals  
 sans cou  
 sin cuello  
 senza collo



**GD25.221.01 - GD25.221.05**  
 Fig. 1 Fig. 2 Fig. 3 Fig. 4 Fig. 5

with neck  
 mit Hals  
 avec cou  
 con cuello  
 con collo



**GD25.223.01 - GD25.223.05**  
 Fig. 1 Fig. 2 Fig. 3 Fig. 4 Fig. 5

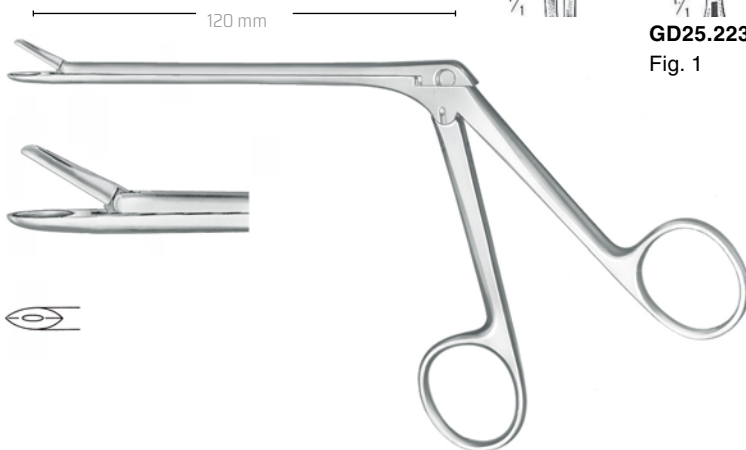

**WEIL-BLAKESLEY**  
**GD25.221.01 - GD25.223.05**



Nasal Cutting Forceps  
Scharfe Nasenzangen  
Pinces coupantes nasales  
Pinzas cortantes nasales  
Pinze taglianti nasali



**GD25.231.01 - GD25.237.03**  
19.0 cm



**STRUYCKEN**

Fig. 1 **GD25.231.01**

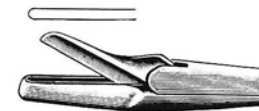

**STRUYCKEN**

Fig. 2 **GD25.231.02**

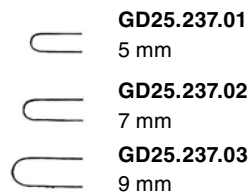

**GD25.237.01**

5 mm

**GD25.237.02**

7 mm

**GD25.237.03**

9 mm



**MYLES**



**GD25.235.05**



**GD25.235.07**



**GD25.235.09**



**GD25.235.11**



**HARTMANN**



**RUBIN**

21.0 cm **GD25.251.21**

Septum Crushing Forceps  
Septum- Quetschzange  
Pince à éraiser la cloison  
Pinza para magullar tabique  
Pinza per ammaccare il setto





Rhinology  
Rhinologie  
Rhinologie  
Rinología  
Rinologia

**GRAND**  
DEVICES  
*The Grand Instruments Company*



**KERRISON**

3 mm x 3 mm **GD25.303.03**  
4 mm x 4 mm **GD25.303.04**  
5 mm x 5 mm **GD25.303.05**  
6 mm x 6 mm **GD25.303.06**  
17 cm

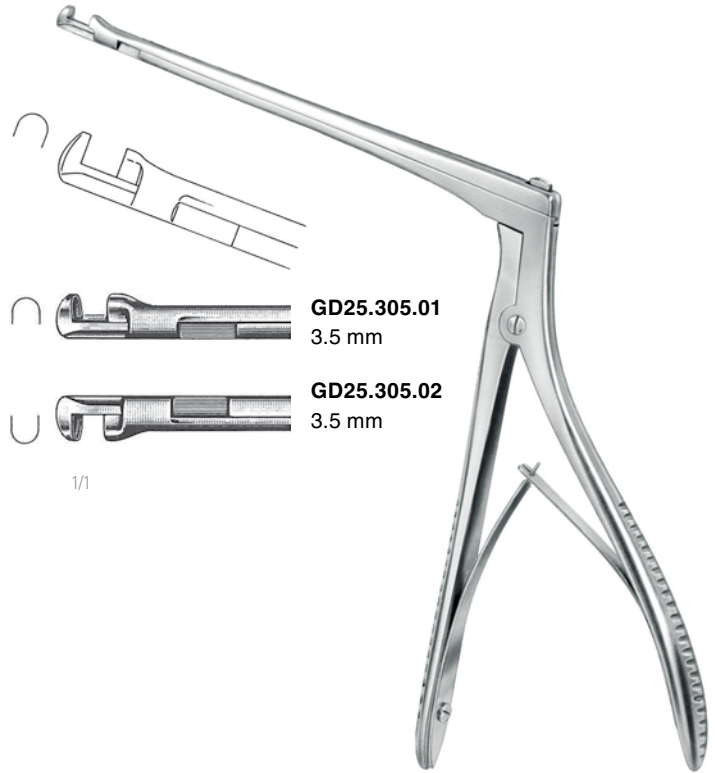

**HAJEK-KOFLER**

**GD25.305.01 - GD25.305.02**

**GD25.305.01**  
3.5 mm  
**GD25.305.02**  
3.5 mm  
1/1



**CITELLI**

1.0 mm **GD25.311.10**  
2.5 mm **GD25.311.25**  
4.0 mm **GD25.311.40**

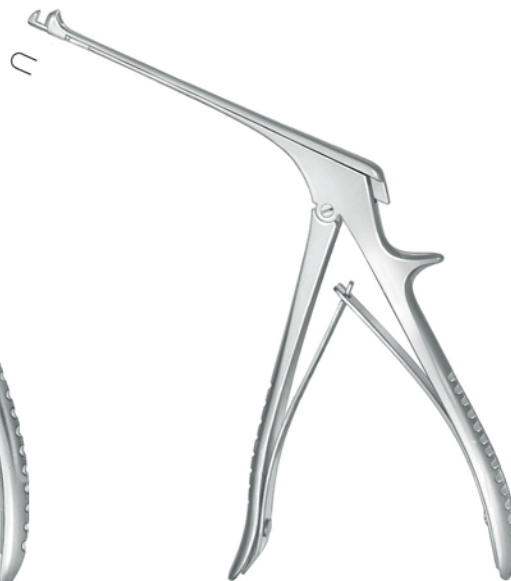

**BEYER**

2.0 mm **GD25.315.20**

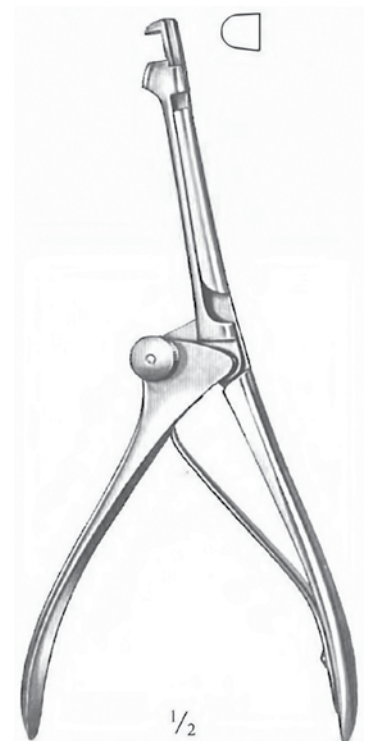

**HAJEK-CLAUS**

20.0 cm **GD25.320.20**



**MIDDLETON-JANSEN**  
 19.0 cm **GD25.323.19**



**MIDDLETON-JANSEN**  
 19.0 cm **GD25.325.19**



**LICHTWITZ**  
 1.5 ø mm **GD25.340.15**  
 1.8 ø mm **GD25.340.18**  
 2.0 ø mm **GD25.340.20**  
 Luer-Lock  
 10.0 cm



**KILLIAN**  
 14 cm / 3 ø mm **GD25.341.03**



**KRAUSE**  
 26.0 cm **GD25.351.26**



**WILDE**  
 24.0 cm **GD25.352.24**



0.3 mm **GD25.355.03**





Nasal Knives  
 Nasenmesser  
 Bistouris nasaux  
 Bisturías nasales  
 Coltelli nasali

**GRAND**  
 DEVICES  
 The Grand Instruments Company

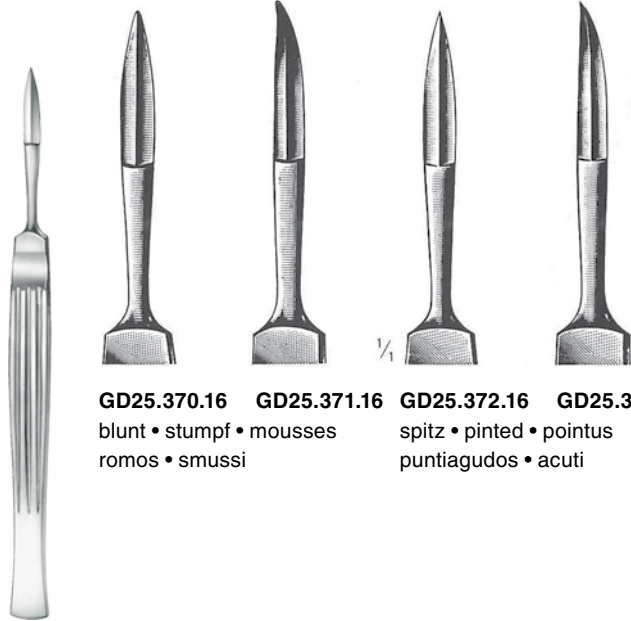

**GD25.370.16** **GD25.371.16** **GD25.372.16** **GD25.373.16**  
 blunt • stumpf • mousses  
 romos • smussi  
 spitz • pinted • pointus  
 puntiagudos • acuti

JOSEPH

GD25.370.16 -  
 GD25.373.16

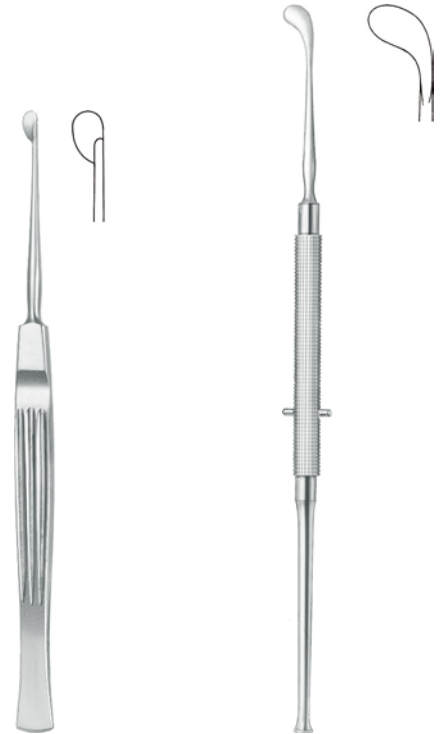

FREER

15.0 cm **GD25.374.15**

FREER

19.0 cm **GD25.375.19**

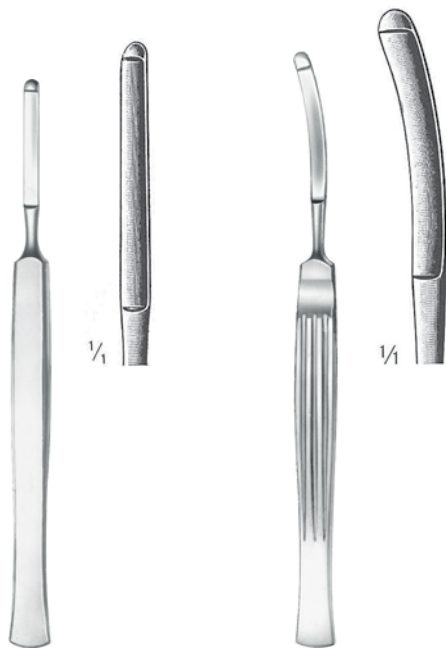

JOSEPH

16.0 cm **GD25.376.16**

CONVERSE

16.0 cm **GD25.379.16**

COTTLE

15.0 cm **GD25.380.15**

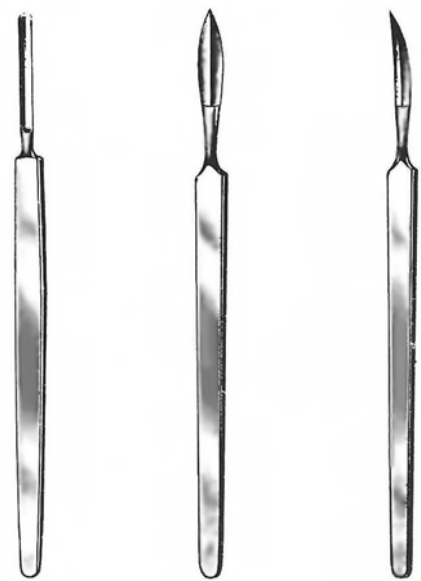

COTTLE

**GD25.382.15**

**GD25.384.15**

**GD25.385.15**

Septum Knives  
 Septum-Messer  
 Couteaux pour la cloison  
 Cuchillos para tabique  
 Coltelli per setto



**BALLENGER**

**GD25.390.03 - GD25.392.05**  
 20.0 cm

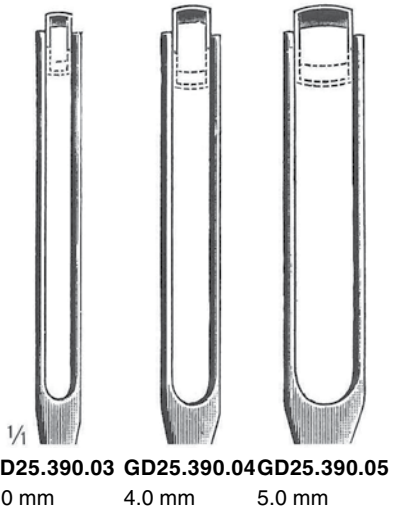

**GD25.390.03** 3.0 mm  
**GD25.390.04** 4.0 mm  
**GD25.390.05** 5.0 mm

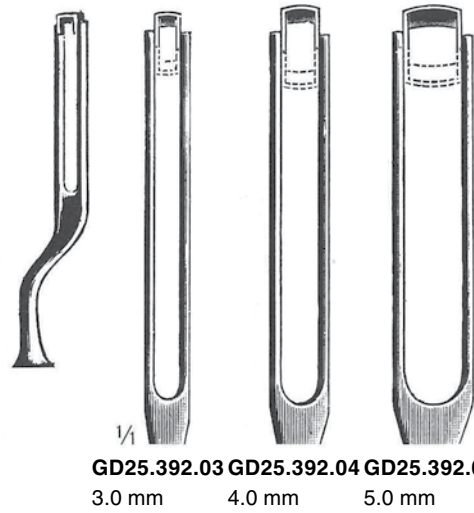

**GD25.392.03** 3.0 mm  
**GD25.392.04** 4.0 mm  
**GD25.392.05** 5.0 mm

Septum Elevators  
 Septum-Elevatorien  
 Elevateurs pour la cloison nasale  
 Elevadores para tabique  
 Elevatori per setto



**BRUENINGS**

16.5 cm **GD25.398.16**



**McKENTY**

**GD25.410.04 - GD25.410.05**  
 15.0 cm

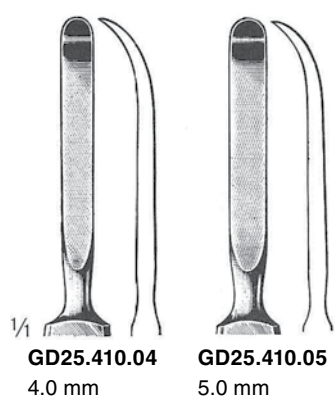

**GD25.410.04** 4.0 mm  
**GD25.410.05** 5.0 mm

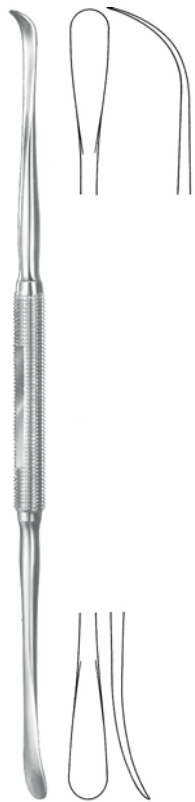

**ROGER**

19.0 cm **GD25.413.19**

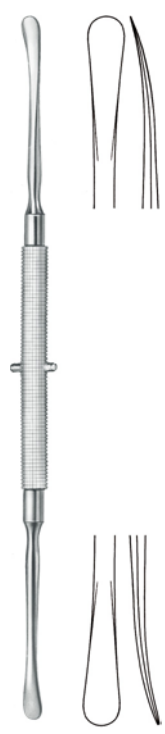

**FREER**

18.0 cm **GD25.415.18**

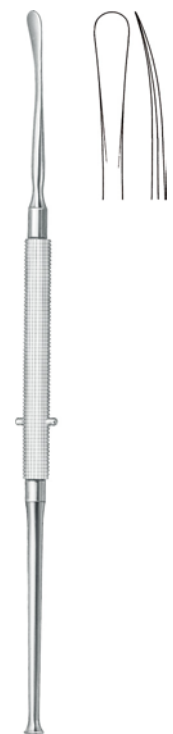

**FREER**

19.0 cm **GD25.417.19**

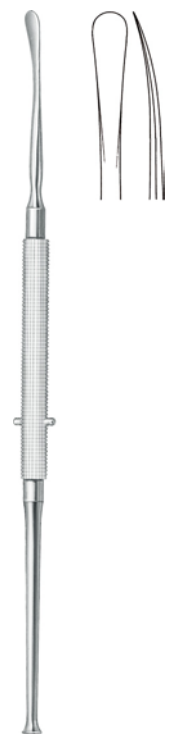

**FREER**

19.0 cm **GD25.419.19**



Rhinology  
Rhinologie  
Rhinologie  
Rinología  
Rinologia

**GRAND**  
DEVICES  
*The Grand Instruments Company*



**COTTLE**

23.0 cm

**GD25.421.23**



**COTTLE**

22.0 cm

**GD25.423.22**



**JOSEPH**

16.0 cm

**GD25.425.16**



**COTTLE**

19.0 cm

**GD25.425.19**



**KILLIAN**

22.0 cm

**GD25.426.22**



**HAJEK-BALLENGER**

22.0 cm

**GD25.428.21**



**BALLENGER**

22.0 cm

**GD25.430.22**



**FREER**

4.0 mm

**GD25.450.04**



**FREER**

4.0 mm

**GD25.451.04**

Rhinoplastic Chisels  
 Nasenplastik-Meißel  
 Ciseaux-burins pour la plastique nasale  
 Cinceles para la plástica nasal  
 Scalpelli per plastica nasale

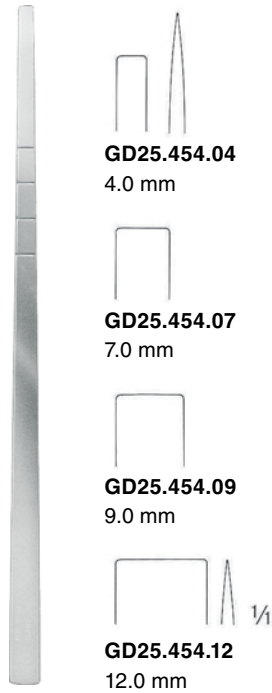

**COTTLE**

**GD25.454.04 - GD25.454.12**  
 18.0 cm



**COTTLE**

18 cm / 6.0 mm **GD25.455.06**

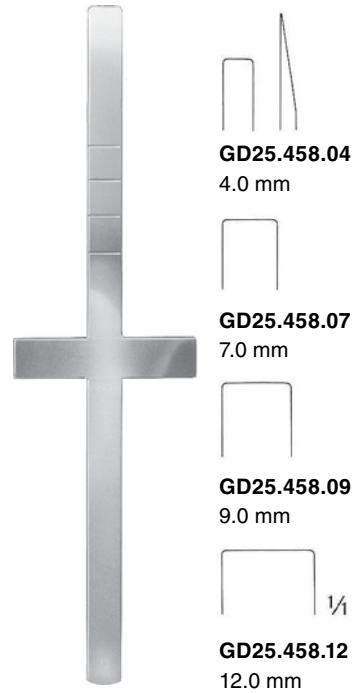

**COTTLE**

**GD25.458.04 - GD25.458.12**

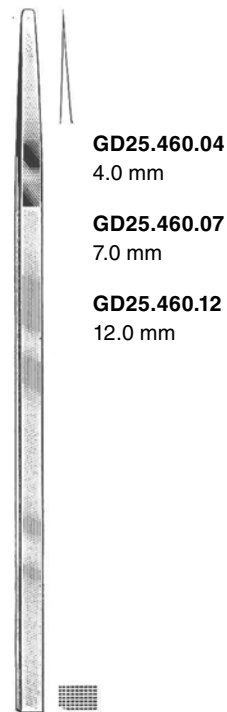

**COTTLE**

**GD25.460.04 - GD25.460.12**  
 18.0 cm

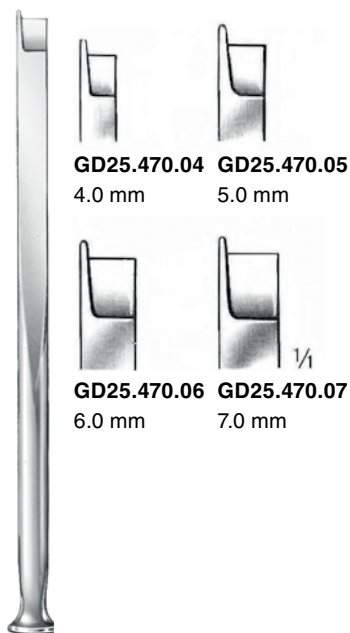

**FOMON**

**GD25.470.04 - GD25.470.07**  
 17.0 cm

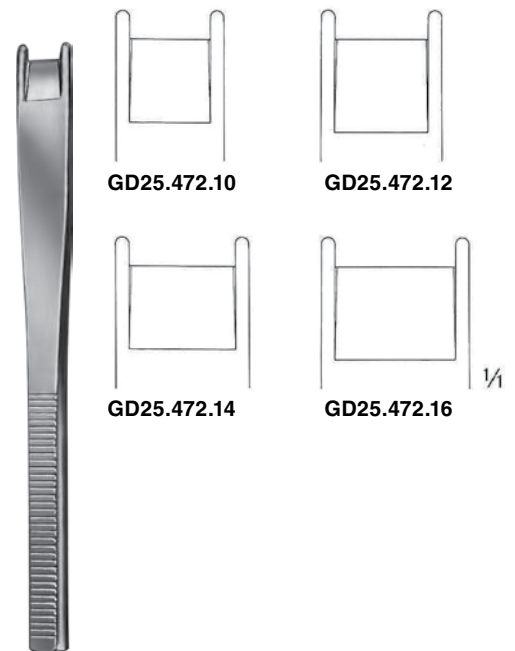

**CINELLI**

**GD25.472.10 - GD25.472.16**



Rhinology  
 Rhinologie  
 Rhinologie  
 Rinología  
 Rinologia

**GRAND**  
 DEVICES  
*The Grand Instruments Company*

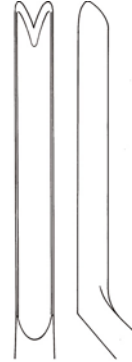
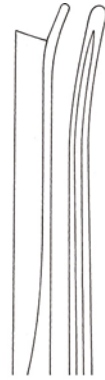
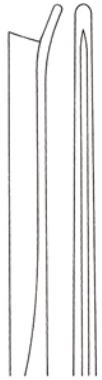

SILVER

SILVER

SILVER

KILLIAN-CLAUS

HAJEK

18.0 cm **GD25.473.01** 18.0 cm **GD25.473.02**

18.0 cm **GD25.473.03** 17 cm / 5.0 mm **GD25.482.05**

4.0 mm **GD25.484.04**  
 6.0 mm **GD25.484.06**  
 8.0 mm **GD25.484.08**

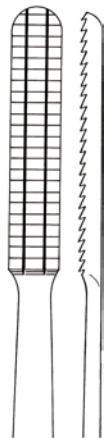
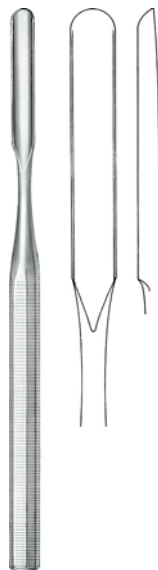

WEST

WEST

FREER

JOSEPH

AUFRICHT

16.0 cm **GD25.486.16** 16.0 cm **GD25.487.16** 6.0 mm **GD25.489.16** 16.0 cm **GD25.502.16**

18.0 cm **GD25.504.18**



GD25.507.18 GD25.507.19

WIENER

GD25.507.18 - GD25.507.19  
18.0 cm

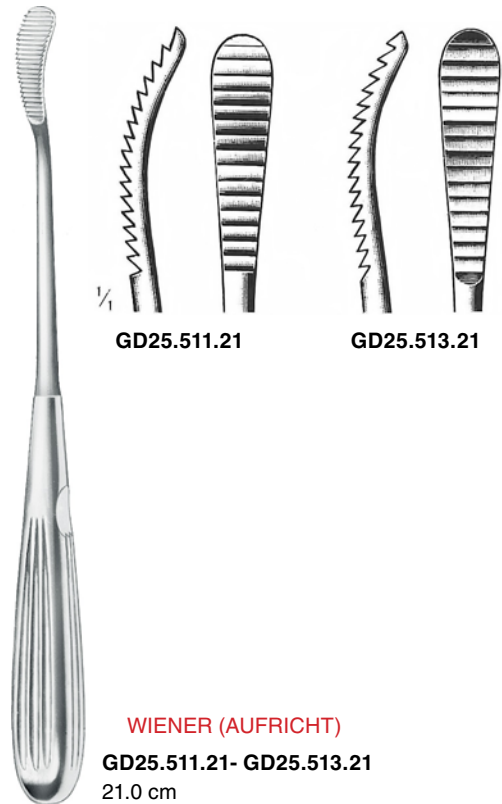

GD25.511.21 GD25.513.21

WIENER (AUFRICHT)

GD25.511.21- GD25.513.21  
21.0 cm

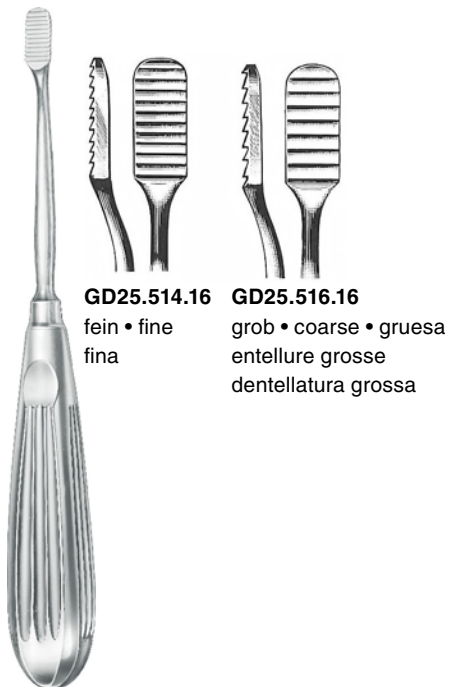

GD25.514.16 GD25.516.16  
fein • fine  
fina  
grob • coarse • gruesa  
entellure grosse  
dentellatura grossa

JOSEPH (LEWIS)

GD25.514.16 - GD25.516.16  
18.0 cm

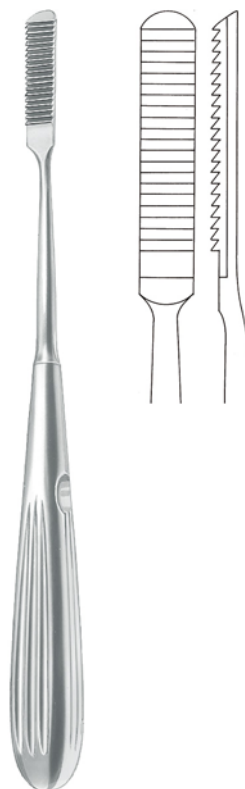

MALTZ (COTTLE)

21.0 cm GD25.518.21

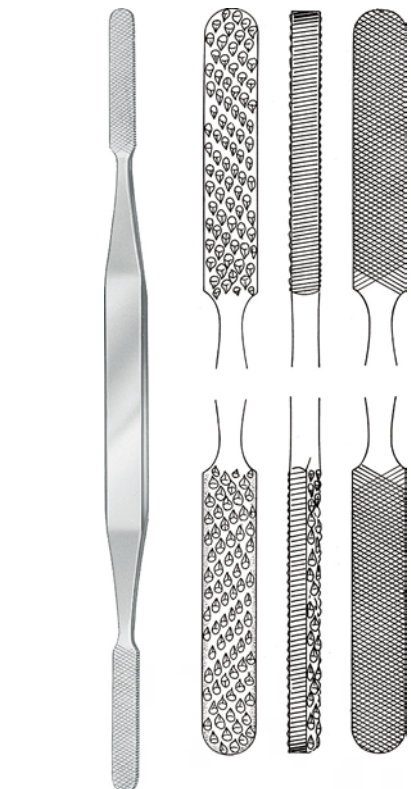

FOMON

21.0 cm GD25.520.21





Rhinology  
 Rhinologie  
 Rhinologie  
 Rinología  
 Rinologia

**GRAND**  
 DEVICES  
 The Grand Instruments Company

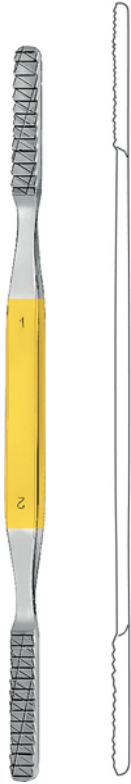

**FOMON**  
 20.0 cm TC



Fig. 1/2

■ GD25.522.01



Fig. 3/4

■ GD25.522.03



Fig. 5/6

■ GD25.522.05



Fig. 7/8

■ GD25.522.07



Fig. 9/10

■ GD25.522.09

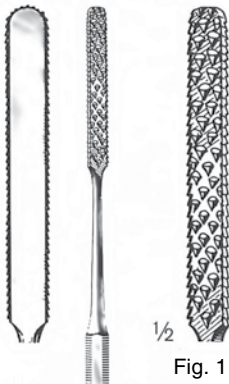

Fig. 1

GD25.526.16

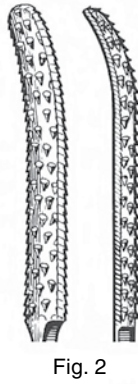

Fig. 2

GD25.527.16

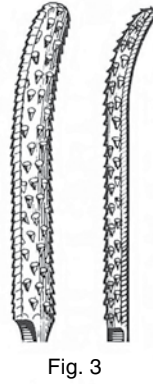

Fig. 3

GD25.529.16



**GALLAHER**





**GD25.532.19**  
 Left • links  
 à gauche  
 izquierda  
 a sinistra

**JOSEPH**  
 19.0 cm

**GD25.534.19**  
 Right • rechts  
 á droite  
 derecha  
 a destra

**GD25.535.01** 17.0 cm **GD25.535.02**

**JOSEPH**

**AUFRICHT**  
 19.0 cm **GD25.551.16**

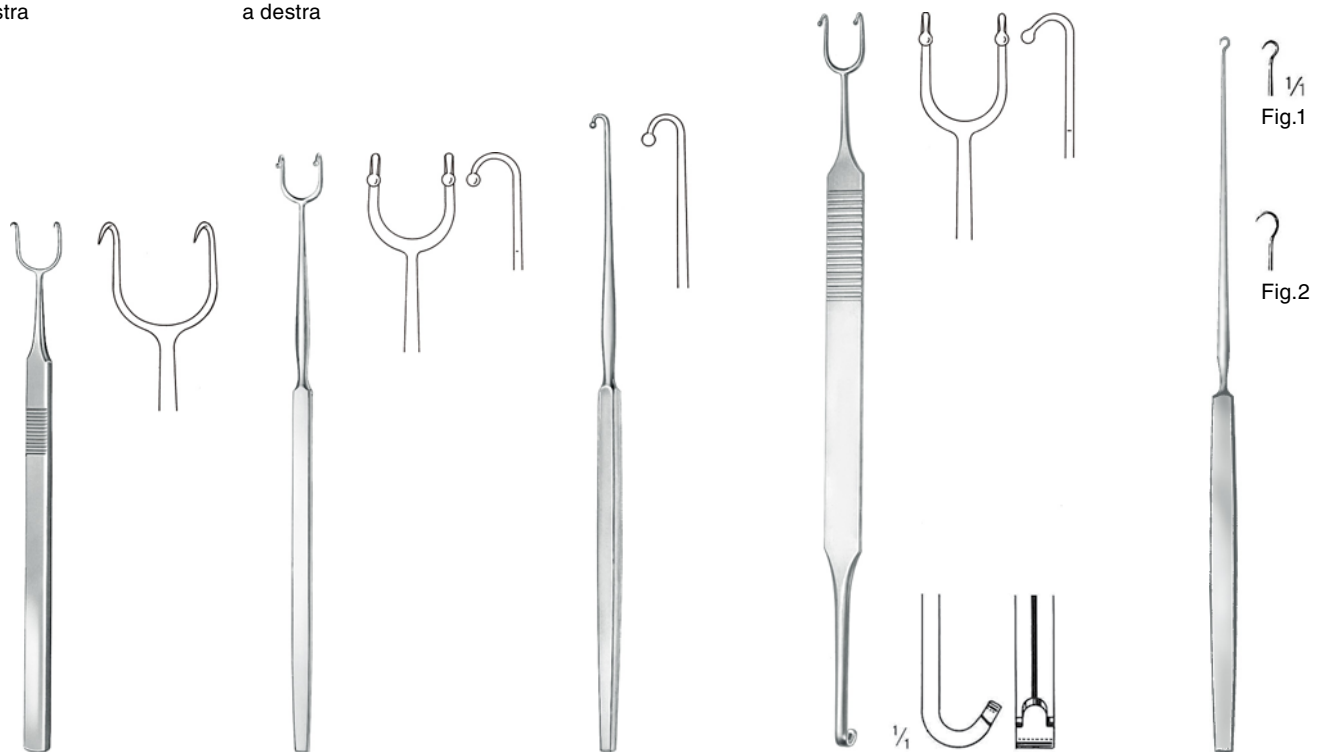

**COTTLE**  
**GD25.556.14**

**FOMON**  
**GD25.556.16**

**FOMON**  
**GD25.557.17**

**COTTLE-NEIVERT**  
**GD25.559.20**

**GILLIES**  
 Fig.1 **GD25.560.18**  
 Fig. 2 **GD25.562.18**  
 18.0 cm



Rhinology  
Rhinologie  
Rhinologie  
Rinología  
Rinologia

**GRAND**  
DEVICES  
The Grand Instruments Company



**ASCH**  
23.0 cm **GD25.571.23**



**GD25.572.23**  
Straight  
gerade  
droite  
recta  
retta



**GD25.573.23**  
Left  
links  
à gauche  
izquierda  
a sinistra



**GD25.575.23**  
Right  
rechts  
à droite  
derecha  
a destra

**WALSHAM**  
23.0 cm **GD25.572.23 - GD25.575.23**



**JATHO**  
**GD25.595.15**



**FAULKNER**  
21.0 cm **GD25.601.21**



**COAKLEY**  
17.0 cm **GD25.607.01 - GD25.607.06**



**GD25.607.01**  
Fig. 1



**GD25.607.02**  
Fig. 2



**GD25.607.03**  
Fig. 3



**GD25.607.04**  
Fig. 4



**GD25.607.05**  
Fig. 5



**GD25.607.06**  
Fig. 6

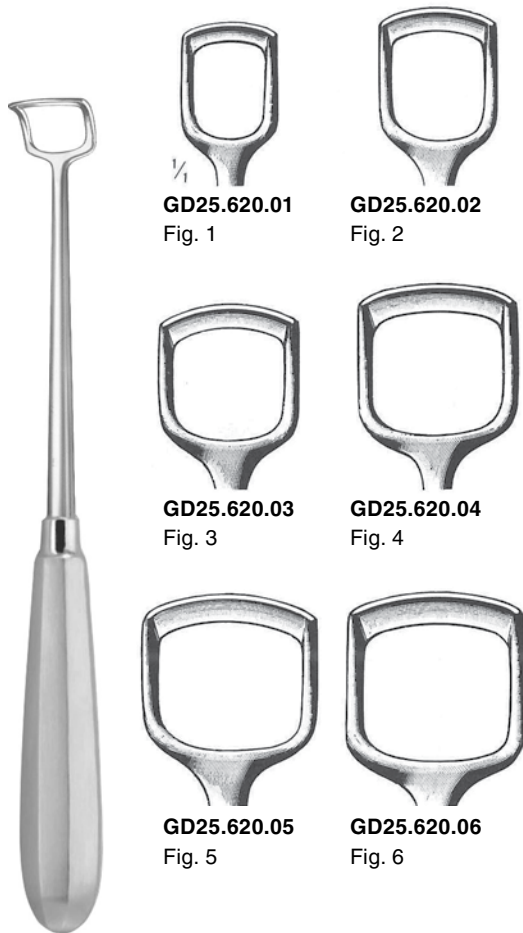

1/4  
**GD25.620.01**  
Fig. 1

**GD25.620.02**  
Fig. 2

**GD25.620.03**  
Fig. 3

**GD25.620.04**  
Fig. 4

**GD25.620.05**  
Fig. 5

**GD25.620.06**  
Fig. 6

**BECKMANN**

22.0 cm **GD25.620.01 - GD25.620.06**

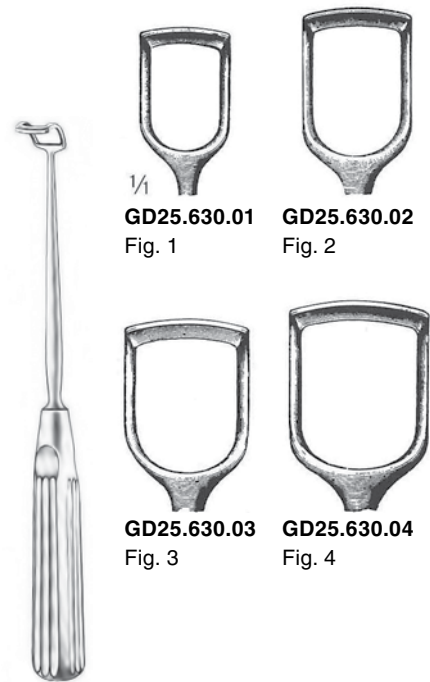

1/4  
**GD25.630.01**  
Fig. 1

**GD25.630.02**  
Fig. 2

**GD25.630.03**  
Fig. 3

**GD25.630.04**  
Fig. 4

**BARNHILL**

21.0 cm **GD25.630.01 - GD25.630.04**

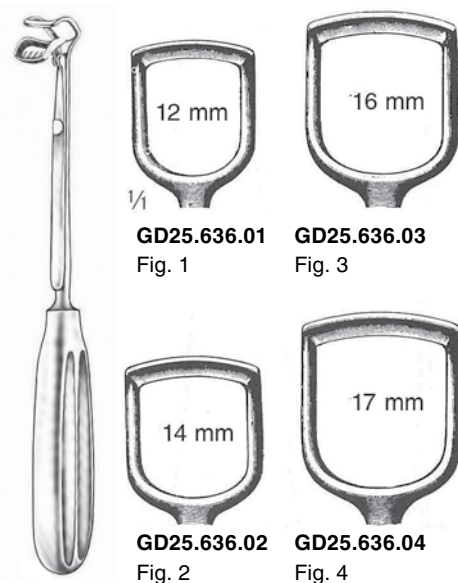

12 mm  
1/4  
**GD25.636.01**  
Fig. 1

16 mm  
**GD25.636.03**  
Fig. 3

14 mm  
**GD25.636.02**  
Fig. 2

17 mm  
**GD25.636.04**  
Fig. 4

**St. CLAIR-THOMSON**

21.0 cm **GD25.636.01 - GD25.636.04**

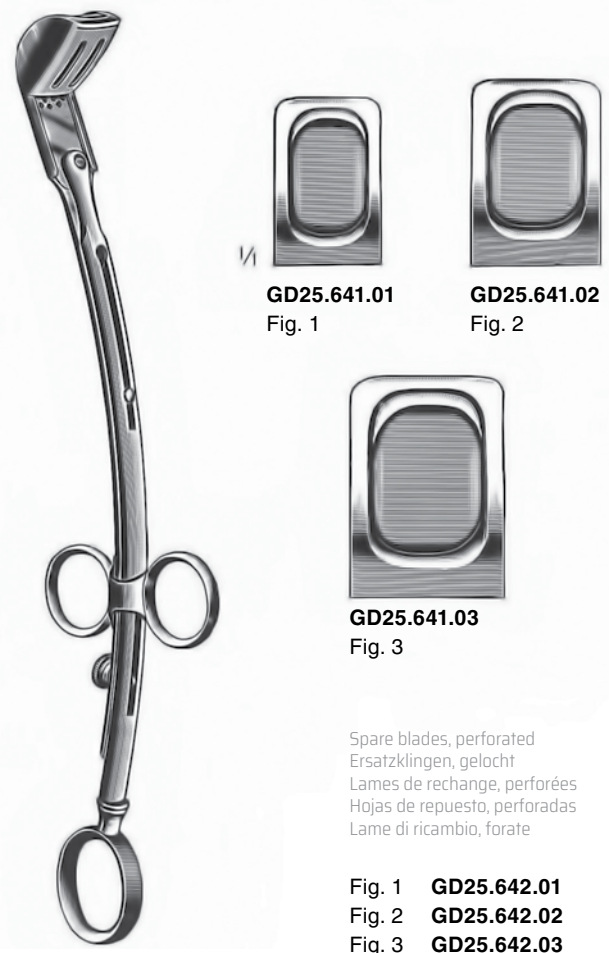

1/4  
**GD25.641.01**  
Fig. 1

**GD25.641.02**  
Fig. 2

**GD25.641.03**  
Fig. 3

Spare blades, perforated  
Ersatzklingen, gelocht  
Lames de rechange, perforées  
Hojas de repuesto, perforadas  
Lame di ricambio, forate

Fig. 1 **GD25.642.01**  
Fig. 2 **GD25.642.02**  
Fig. 3 **GD25.642.03**

**LAFORCE**

25.0 cm **GD25.641.01 - GD25.641.03**



Intestines and Stomach  
Darm, Magen  
Intestin, Estomac  
Intestines, Estómago  
Intestini, Stomaco  
肠胃

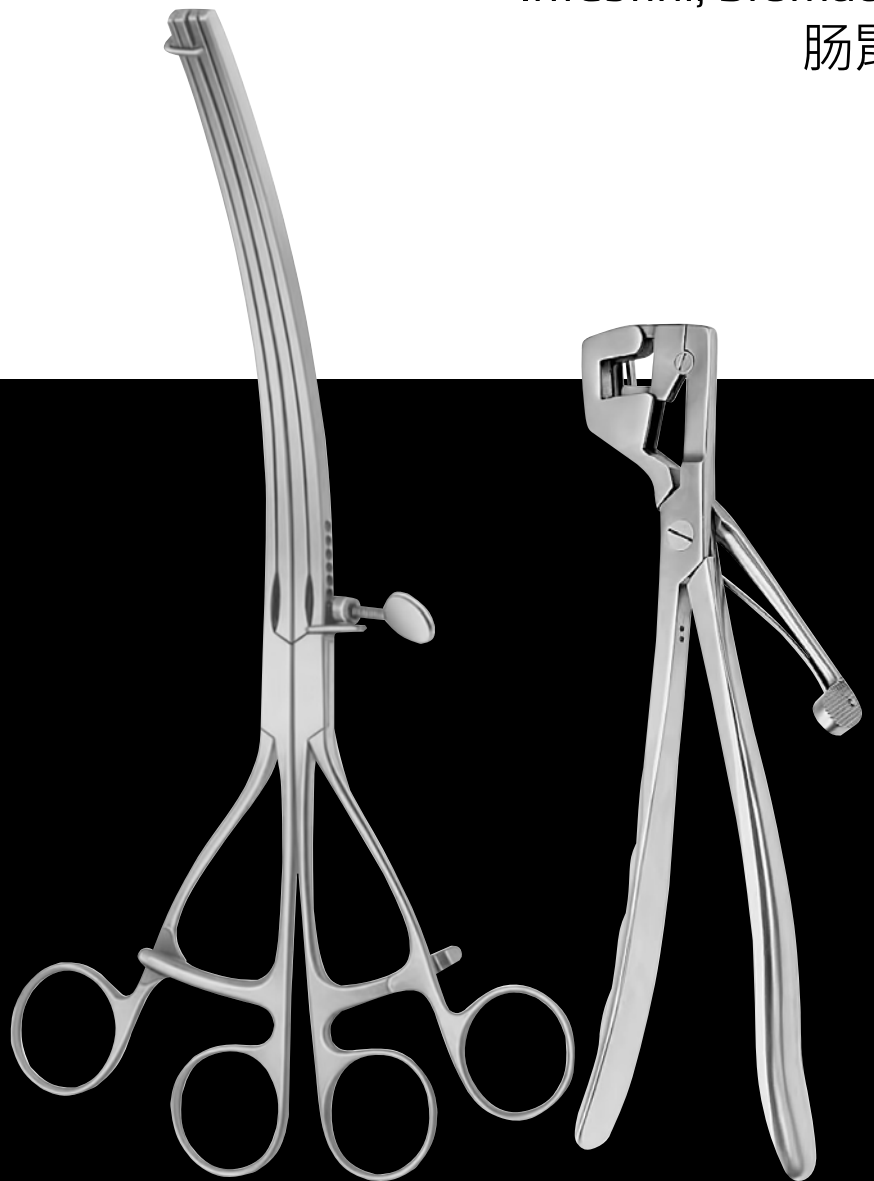

**GD**26



**Bowel and Tissue Grasping Forceps**  
**Darm- und Gewebefaßzangen**  
**Pinces à saisir les intestins et les tissus**  
**Pinzas para coger intestinos y tejidos**  
**Pinze per afferrare intestini e tessuti**

**GRAND**  
 DEVICES  
*The Grand Instruments Company*

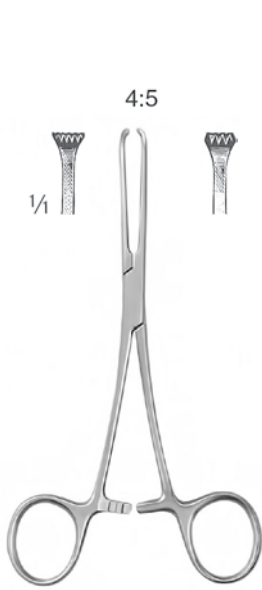

**ALLIS-Baby**

14.0 cm **GD26.102.14**



**ALLIS**

15.0 cm **GD26.110.15**  
 19.0 cm **GD26.120.19**  
 22.0 cm **GD26.120.22**  
 24.0 cm **GD26.120.24**



**ALLIS**

16.0 cm **GD26.124.16**  
 20.0 cm **GD26.124.20**  
 25.0 cm **GD26.124.25**



**ALLIS-ADAIR**

15.5 cm **GD26.130.15**

atraumatic  
 atraumatich  
 atraumatiques  
 atraumáticas  
 atraumatiche



**JUDD-ALLIS**

15.0 cm **GD26.140.15**  
 19.0 cm **GD26.140.19**



**THOMS-ALLIS**

20.0 cm **GD26.150.20**

TC Lined  
 Mit TC-Einsätzen  
 A mors TC  
 Con bocas TC  
 Con morso TC



**BABCOCK TC**

16.0 cm **GD26.160.16** **GD26.164.16** **GD26.168.16**  
 18.0 cm **GD26.160.18**  
 20.0 cm **GD26.160.20** **GD26.164.20** **GD26.168.20**  
 24.0 cm **GD26.160.24**

atraumatic  
 atraumatich  
 atraumatiques  
 atraumáticas  
 atraumatiche

Intestines and Stomach  
 Darm, Magen  
 Intestin, Estomac  
 Intestines, Estómago  
 Intestini, Stomaco



TC Lined  
 Mit TC-Einsätzen  
 A mors TC  
 Con bocas TC  
 Con morso TC

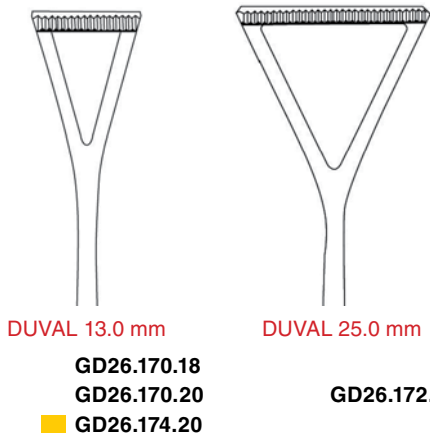

**DUVAL 13.0 mm**  
**GD26.170.18**  
**GD26.170.20**  
**GD26.174.20**

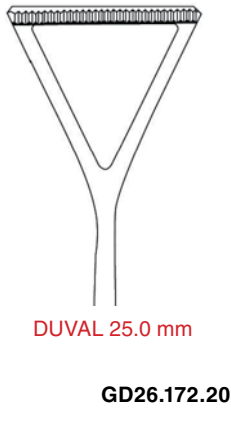

**DUVAL 25.0 mm**  
**GD26.172.20**  
**GD26.172.23**



**DUVAL**  
**GD26.170.18 - GD26.174.20**

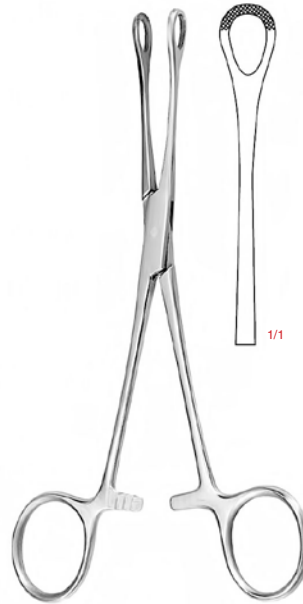

**WILLIAMS**  
 16.5 cm **GD26.180.16**



**SCHOENBURG**  
 22.0 cm **GD26.182.22**



Intestinal Forceps  
 Darmklemmen  
 Pinzas intestinales  
 Pinzas intestinales  
 Pinze intestinali

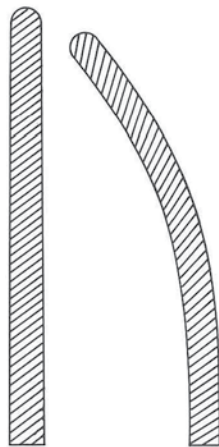

**DOYEN-Baby**

16.0 cm  
 18.0 cm **GD26.210.18** **GD26.211.18**  
 21.0 cm  
 23.0 cm

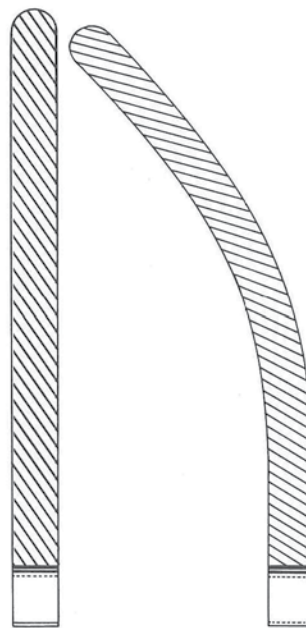

**DOYEN**

**GD26.210.21** **GD26.211.21**  
**GD26.210.23** **GD26.211.23**

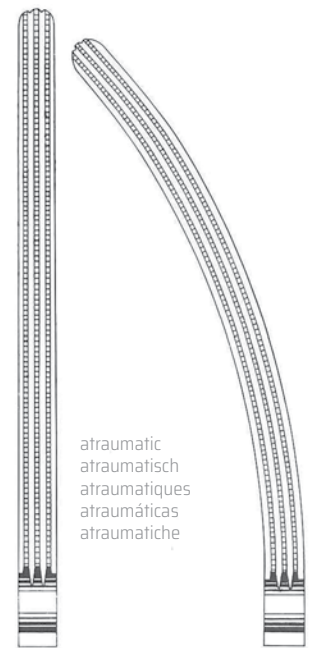

atraumatic  
 atraumatisch  
 atraumatiques  
 atraumáticas  
 atraumatiche

**DOYEN**

**GD26.216.16** **GD26.217.16**  
**GD26.216.18** **GD26.217.18**  
**GD26.216.21** **GD26.217.21**  
**GD26.216.23** **GD26.217.23**





Intestines and Stomach  
 Darm, Magen  
 Intestin, Estomac  
 Intestines, Estómago  
 Intestini, Stomaco

**GRAND**  
 DEVICES  
*The Grand Instruments Company*

Intestinal Forceps  
 Darmklemmen  
 Pinces intestinales  
 Pinzas intestinales  
 Pinze intestinali

**KOCHER**

<b>GD26.220.22 - GD26.227.28</b>	22.0 cm	<b>GD26.220.22</b>	<b>GD26.221.22</b>
	25.0 cm	<b>GD26.220.25</b>	<b>GD26.221.25</b>
	28.0 cm	<b>GD26.220.28</b>	<b>GD26.221.28</b>

**KOCHER**

<b>GD26.226.22</b>	<b>GD26.227.22</b>
<b>GD26.226.25</b>	<b>GD26.227.25</b>
<b>GD26.226.28</b>	<b>GD26.227.28</b>

atraumatic  
 atraumatisch  
 atraumatiques  
 atraumáticas  
 atraumatiche



Intestinal Forceps  
Darmklemmen  
Pinces intestinales  
Pinzas intestinales  
Pinze intestinali



**MAYO-ROBSON**

**GD26.230.25 - GD26.237.25**



25.0 cm **GD26.230.25**

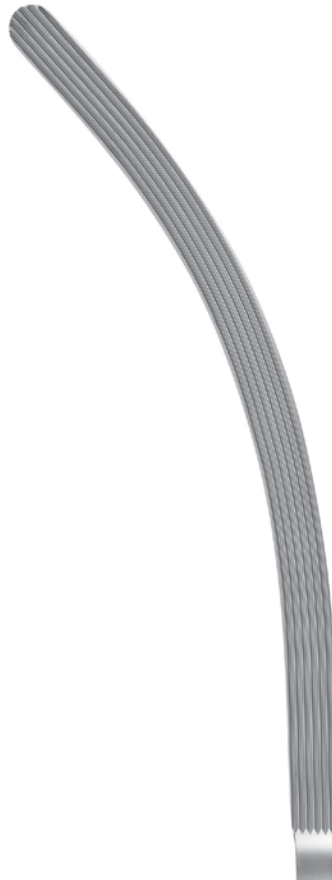

**MAYO-ROBSON**

**GD26.231.25**



**GD26.236.25**



**GD26.2377.25**

atraumatic  
atraumatich  
atraumatiques  
atraumáticas  
atraumatiche



Intestines and Stomach  
 Darm, Magen  
 Intestin, Estomac  
 Intestines, Estómago  
 Intestini, Stomaco

**GRAND**  
 DEVICES  
 The Grand Instruments Company

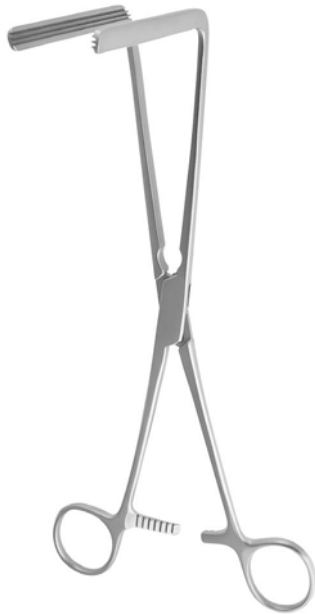

Normal **FEHLAND** Atraum  
**GD26.241.23** 23.5 cm **GD26.247.23**

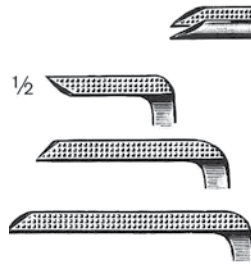

**BEST**  
 30.0 mm **GD26.251.30**  
 60.0 mm **GD26.251.60**  
 75.0 mm **GD26.251.75**

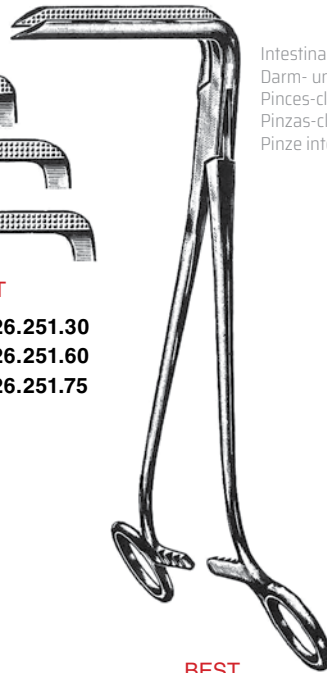

Intestinal and Stomach Clamps  
 Darm- und Magenklappen  
 Pinces-clamps intestinales  
 Pinzas-clamps intestinales y estomacales  
 Pinze intestinali e stomacali

**BEST**  
**GD26.251.30** 26.5 cm **GD26.251.75**



**BRUNNER**  
**GD26.260.24** 24.0 cm **GD26.266.24**

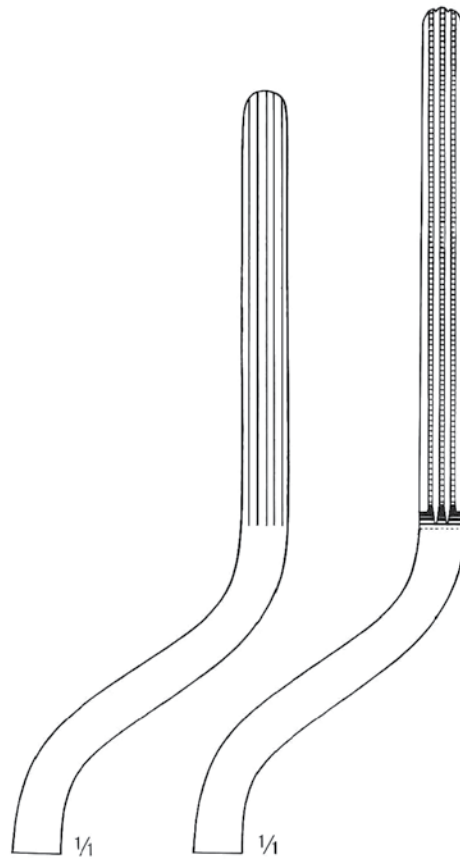

**BRUNNER**  
**GD26.260.24** **GD26.266.24**

atraumatic  
 atraumatisch  
 atraumatiques  
 atraumáticas  
 atraumatiche



**STONE**  
 15.5 cm **GD26.270.15**



**STONE-WATT**  
**GD26.274.00**



**STONE-WATT**  
 7.5 cm **GD26.272.07**  
 10.0 cm **GD26.272.10**

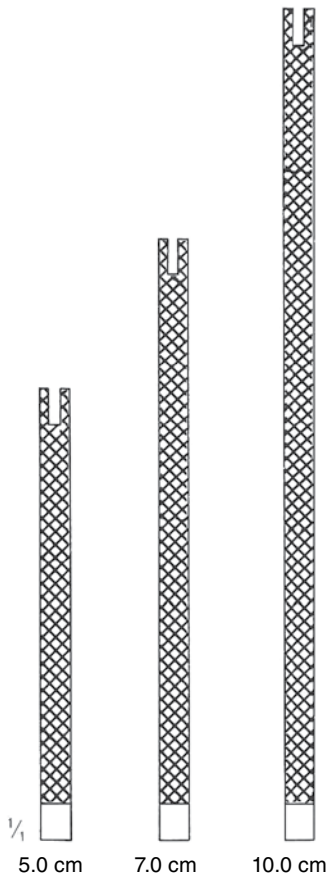

Anastomosis Clamps and Accessories  
 Anastomosenklemmen und Zubehör  
 Clamps á anastomose et accessoires  
 Clamps para anastomosis y accesorios  
 Pinze per anastomosi e accessori



**DE MARTEL-WOLFSON**  
 5.0 cm **GD26.280.05**  
 7.0 cm **GD26.280.07**  
 10.0 cm **GD26.280.10**

Set / 2



**DE MARTEL - WOLFSON**  
 26.0 cm **GD26.282.26**



**DE MARTEL - WOLFSON**  
 8.5 cm **GD26.284.08** 23.0 cm **GD26.284.23**



Intestines and Stomach  
Darm, Magen  
Intestin, Estomac  
Intestines, Estómago  
Intestini, Stomaco

**GRAND**  
DEVICES  
*The Grand Instruments Company*

Stomach Clamps  
Magenklemmen  
Pincas-clamps stomacales  
Pinzas-clamps estomacales  
Pinze stomacali

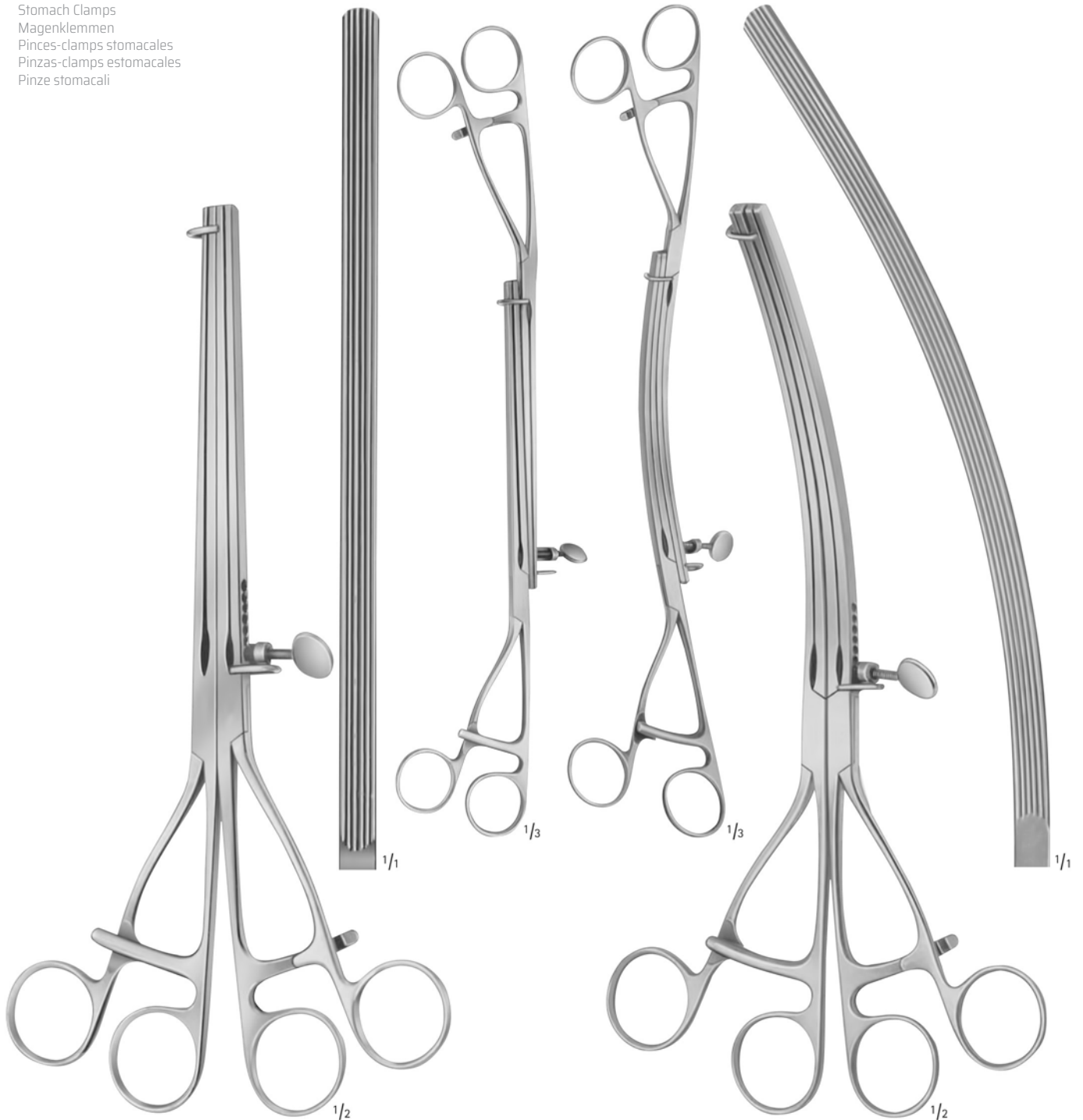

**LANE**  
30.0 cm **GD26.290.30**

**LANE**  
30.0 cm **GD26.291.30**



Stomach Clamps  
Magenklemmen  
Pincés-clamps stomacales  
Pinzas-clamps estomacales  
Pinze stomacali

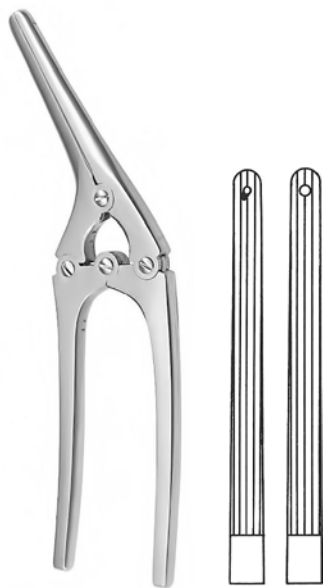

**PAYR-Baby**

15.0 cm **GD26.310.15**



**PAYR**

21.0 cm **GD26.310.21**

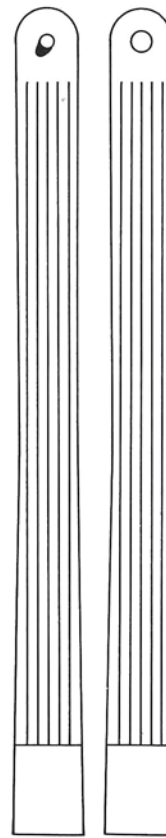

29.0 cm **GD26.310.29**

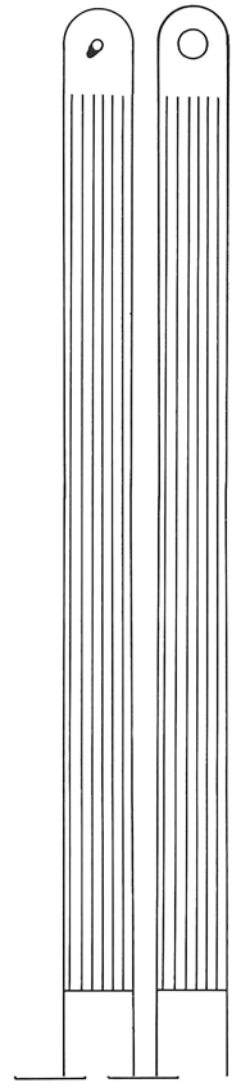

35.0 cm **GD26.310.35**





Gall Bladder, Kidney  
Galle, Niere  
Vesicule biliaire, Rein  
Vesicula biliar, Riñón  
Vesicola biliare, Rene  
胆囊和肾脏



**GD27**



Gall Stone Forceps  
Gallensteinzangen  
Pincés pour calculs biliaries  
Pinzas para cálculos biliaries  
Pinze per calcoli biliari

**GRAND**  
DEVICES  
*The Grand Instruments Company*



**DESJARDINS**

23.0 cm **GD27.101.23**  
23.0 cm **GD27.103.23**



**GD27.101.23**  
Fig. 1

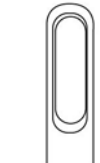

**GD27.103.23**  
Fig. 2



**DESJARDINS**

24.0 cm **GD27.103.24**  
22.5 cm **GD27.103.25**



**GD27.103.24**

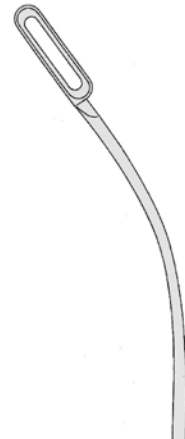

**GD27.103.25**

very slender pattern  
sehr schlankes Modell  
modèle très fin  
modelo muy delgado  
modello molto delicato

Gall Stone Forceps  
Gallensteinzangen  
Pincés pour calculs biliaires  
Pinzas para cálculos biliares  
Pinze per calcoli biliari



**CZERNY**

25.0 cm **GD27.105.25**

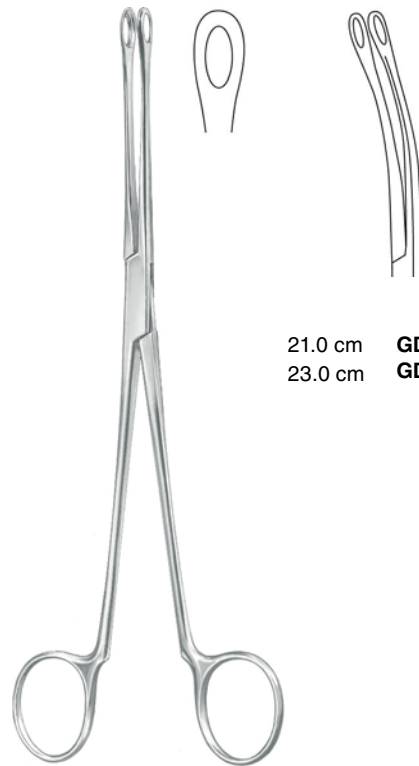

**BLAKE**

21.0 cm **GD27.106.20**

21.0 cm **GD27.107.20**  
23.0 cm **GD27.107.23**



Gall Stone Forceps  
Gallensteinzangen  
Pincés pour calculs biliaires  
Pinzas para cálculos biliares  
Pinze per calcoli biliari

**GRAND**  
DEVICES  
*The Grand Instruments Company*



**MAYO BLAKE**  
20.0 cm **GD27.110.20**



**MAYO BLAKE**  
20.0 cm **GD27.111.20**



**MIXTER**  
22.0 cm **GD27.117.22**



Gall Stone Scoops  
 Gallensteinlöffel  
 Curettes pour calculs biliaires  
 Cucharillas para coger cálculos biliares  
 Cuchhiai per calcoli biliari



**MOORE**

28.0 cm **GD27.125.28**

elastic  
 federnd  
 élastiques  
 elásticas  
 elastiche



**GD27.130.13**



**GD27.130.18**



**GD27.130.21**

**DESSARDINS**

28.0 cm **GD27.130.13**

28.0 cm **GD27.130.18**

28.0 cm **GD27.130.21**

Gall Stone Probes  
 Gallensteinsonde  
 Sondes à calculs biliaires  
 Sondas-exploradoras para cálculos biliares  
 Sonde per calcoli biliari

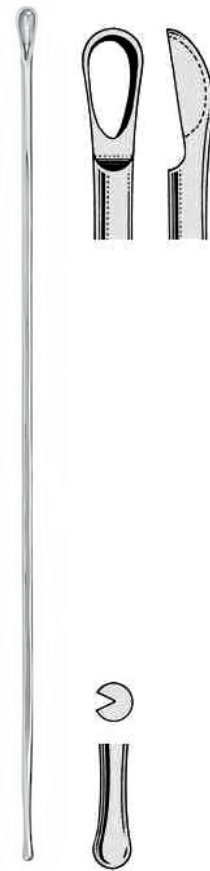

**MOYNIHAN**

34.0 cm **GD27.142.34**



Gall Duct Dilators  
Gallenkanaldilatatoren  
Dilatateurs pour les voies biliaires  
Dilatadores para conducto biliar  
Dilatatori per condotti biliari

**GRAND**  
DEVICES  
*The Grand Instruments Company*

malleable shaft  
biegsamer Schaft  
tige malléable  
vástago maleable  
gambo flessibile

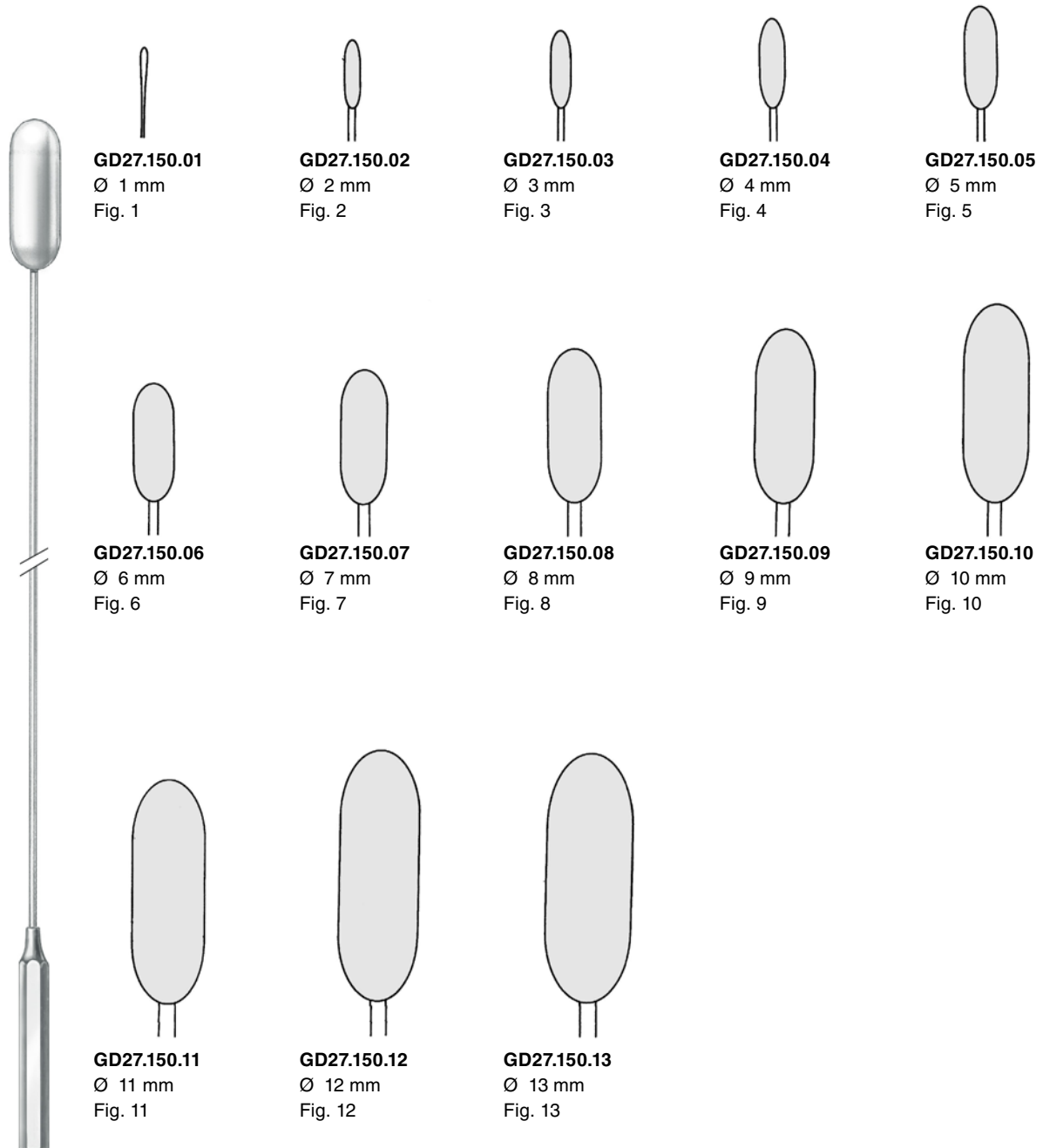

**BAKES**

32.0 cm **GD27.150.01 - GD27.150.13**

**BAKES**

**GD27.150.00**

set of 9 pieces in canvas pocket  
Satz à 9 Stück in Leinentuchtaschen  
jeu de 9 pièces dans une poche en toile  
juego de 9 unidades en bolsa de tela  
set di 9 pezzi

**GD27.150.03 - GD27.150.11**

Gall Stone Scoops  
Gallensteinlöffel  
Curettes pour calculs biliaries  
Cucharas para cálculos biliaries  
Pinze per calcoli biliari



**FERGUSSON**  
21.5 cm **GD27.170.21**



**MAYO**  
28.0 cm **GD27.175.27**



**MAYO**  
27.0 cm **GD27.178.01**  
27.0 cm **GD27.178.02**  
27.0 cm **GD27.178.03**





Gall Stone Scoops  
Gallensteinlöffel  
Curettes pour calculs biliaries  
Cucharas para cálculos biliaries  
Pinze per calcoli biliari

**GRAND**  
DEVICES  
*The Grand Instruments Company*

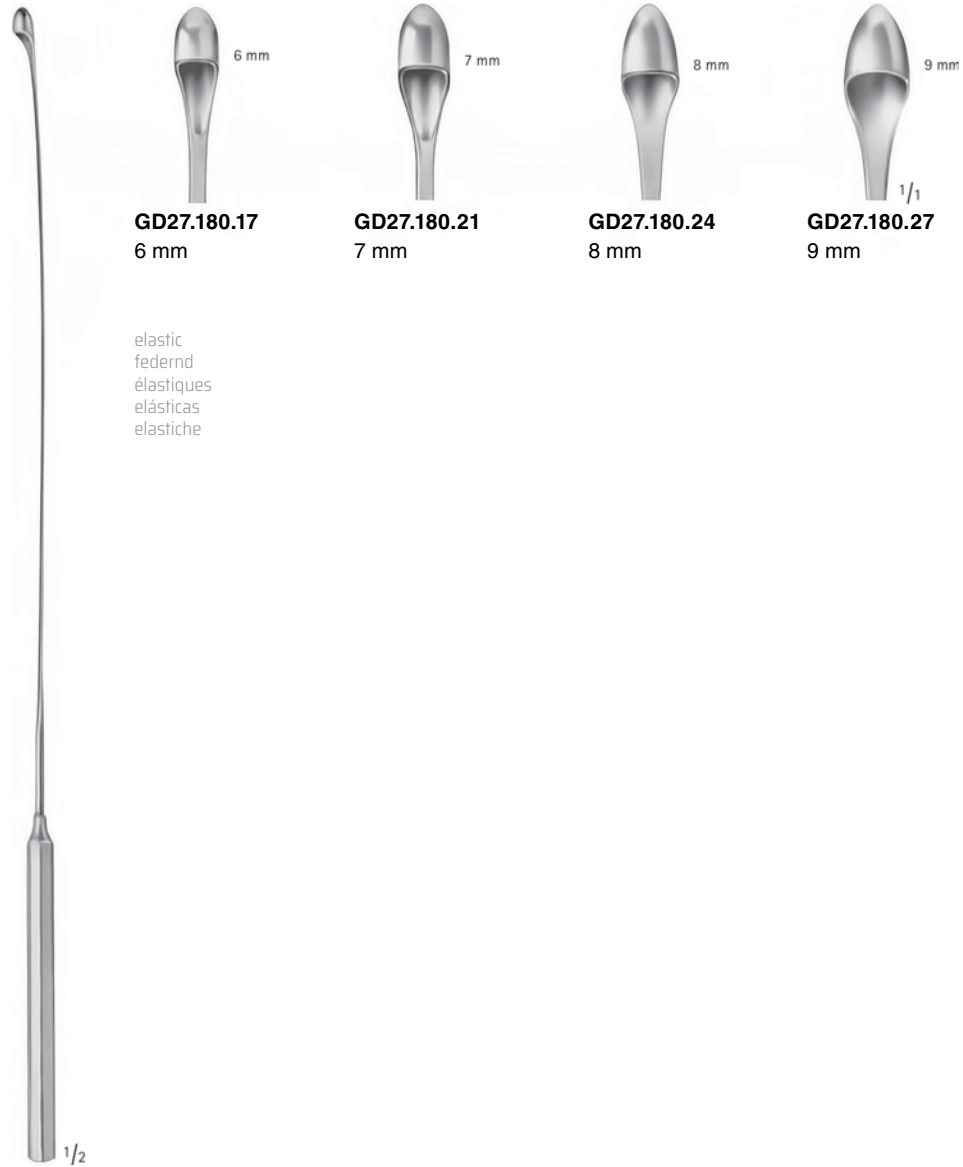

**GD27.180.17**  
6 mm

**GD27.180.21**  
7 mm

**GD27.180.24**  
8 mm

**GD27.180.27**  
9 mm

elastic  
federnd  
élastiques  
elásticas  
elastiche

**DESJARDINS**

30.0 cm **GD27.180.17**  
30.0 cm **GD27.180.21**  
30.0 cm **GD27.180.24**  
30.0 cm **GD27.180.27**

Gall Stone Scoops  
Gallensteinlöffel  
Curettes pour calculs biliaries  
Cucharas para cálculos biliari  
Pinze per calcoli biliari

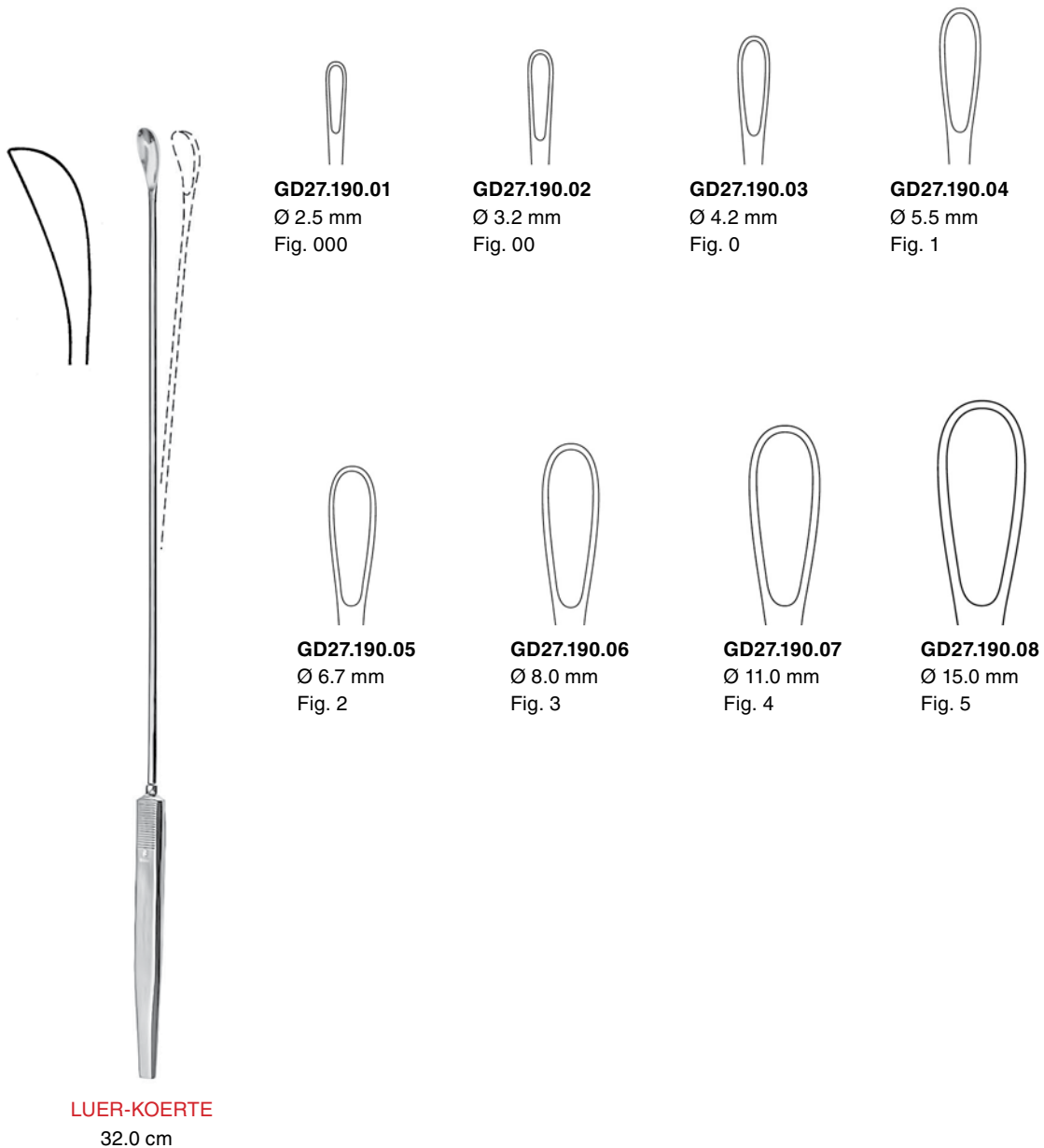



Ureter Clamps  
Ureterklemmen  
Pincés-clapms uretère  
Pinzas clamps para ureter  
Pinze per uretere

**GRAND**  
DEVICES  
*The Grand Instruments Company*



MAYO <sup>1/2</sup>

32.0 cm **GD27.210.32**



LURZ

21.0 cm **GD27.221.21**



LURZ

21.0 cm **GD27.223.21**

Kidney Stone Forceps  
 Nierensteinzangen  
 Pincas pour les calculs du bassinot  
 Pinzas para cálculos renales  
 Pinze per calcoli renali

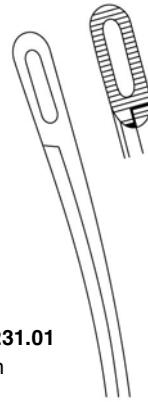

**GD27.231.01**  
 23.0 cm  
 Fig. 1

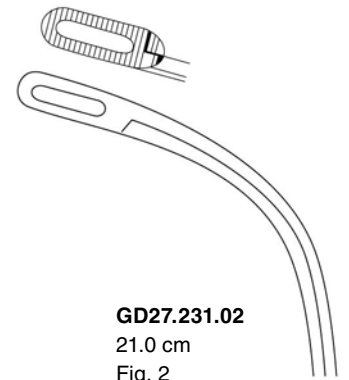

**GD27.231.02**  
 21.0 cm  
 Fig. 2

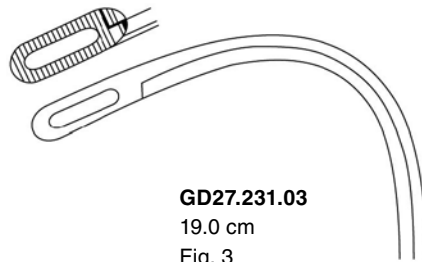

**GD27.231.03**  
 19.0 cm  
 Fig. 3

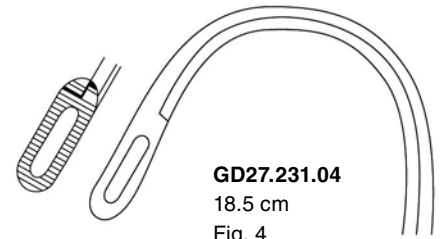

**GD27.231.04**  
 18.5 cm  
 Fig. 4

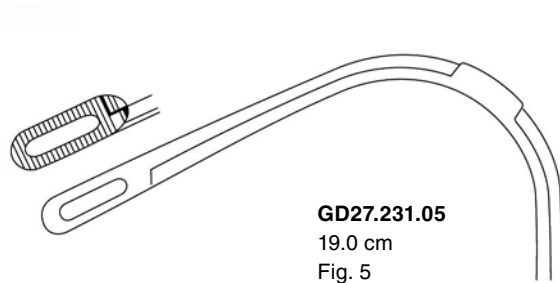

**GD27.231.05**  
 19.0 cm  
 Fig. 5

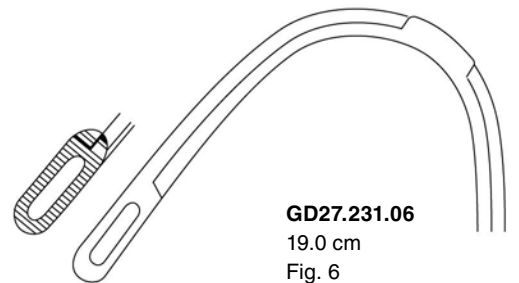

**GD27.231.06**  
 19.0 cm  
 Fig. 6



**RANDALL**

- Fig. 1 **GD27.231.01**
- Fig. 2 **GD27.231.02**
- Fig. 3 **GD27.231.03**
- Fig. 4 **GD27.231.04**
- Fig. 5 **GD27.231.05**
- Fig. 6 **GD27.231.06**



Kidney Stone Forceps  
Nierensteinzangen  
Pinces pour les calculs du bassin  
Pinzas para cálculos renales  
Pinze per calcoli renali

**GRAND**  
DEVICES  
The Grand Instruments Company

delicate pattern  
feines Modell  
modèle délicat  
modelo fino  
modello delicato



**GD27.231.23**  
23.0 cm  
Fig. 1

**GD27.231.24**  
24.5 cm  
Fig. 1

**RANDALL**

Fig. 1 **GD27.231.23**  
Fig. 2 **GD27.231.24**

Kidney Stone Forceps  
 Nierensteinzangen  
 Pincès pour les calculs du bassinèt  
 Pinzas para cálculos renales  
 Pinze per calcoli renali



**GD27.233.16**  
 16.0 cm  
 Fig. 1

Nephrostomy Forceps  
 Nierenfistelzangen  
 Pincès à néphrostomie  
 Pinzas para nefrostomia  
 Pinze per nefrostomia

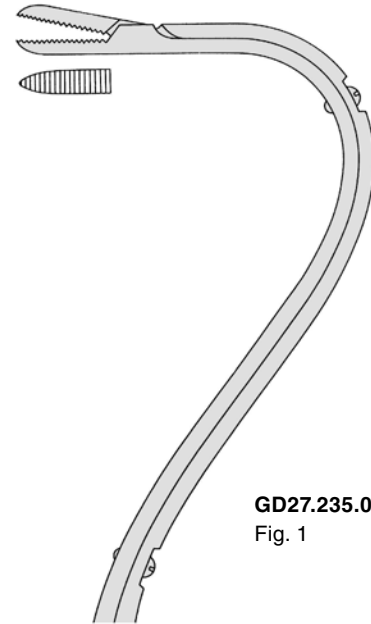

**GD27.235.01**  
 Fig. 1

For Children  
 für Kinder  
 pour enfants  
 para niños  
 per bambini



**HEIMING**

Fig. 1 **GD27.233.16**  
 Fig. 2 **GD27.233.17**



**GD27.233.17**  
 17.0 cm  
 Fig. 2



**ELSAESSER**

21.0 cm Fig. 1 **GD27.235.01**  
 21.0 cm Fig. 2 **GD27.235.02**

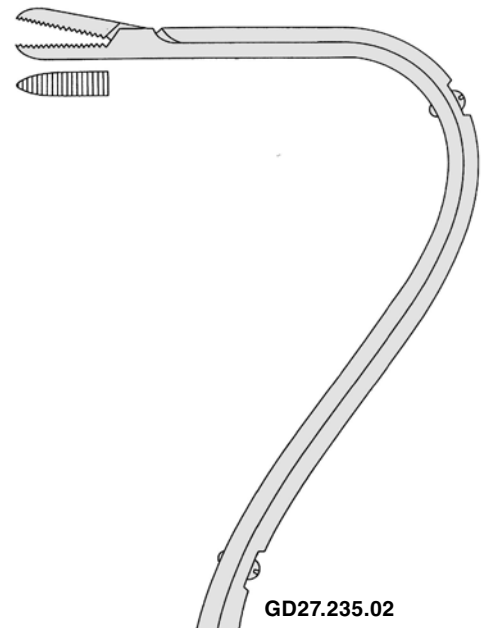

**GD27.235.02**  
 Fig. 2





Urology  
Urologie  
Urologie  
Urología  
Urologia  
泌尿科



**GD28**



Prostatic Retractors, Grasping Forceps  
Prostata Haken, -Faßzange  
Ecarteurs à prostate, Pince à saisir la prostate  
Separadores, Pinza para coger prostata  
Divaricatori, Pinza per afferrare la prostata

**GRAND**  
DEVICES  
*The Grand Instruments Company*



YOUNG

21.5 cm **GD28.101.21**



YOUNG

21.5 cm **GD28.102.22**



YOUNG

20.5 cm **GD28.103.22**



YOUNG

22.0 cm **GD28.105.21**



YOUNG

20.0 cm **GD28.106.20**

Capsule Forceps, Ligature Carrying Forceps  
 Kapselzangen, Fadenführungszange  
 Pinces pour saisir les capsules. Pince porte-fil  
 Pinzas capsulares, Pinze porta ligaduras  
 Pinze per afferrare capsule, Pinza porta-filo



MILLIN

24.5 cm **GD28.111.23**



MILLIN

24.5 cm **GD28.115.24**

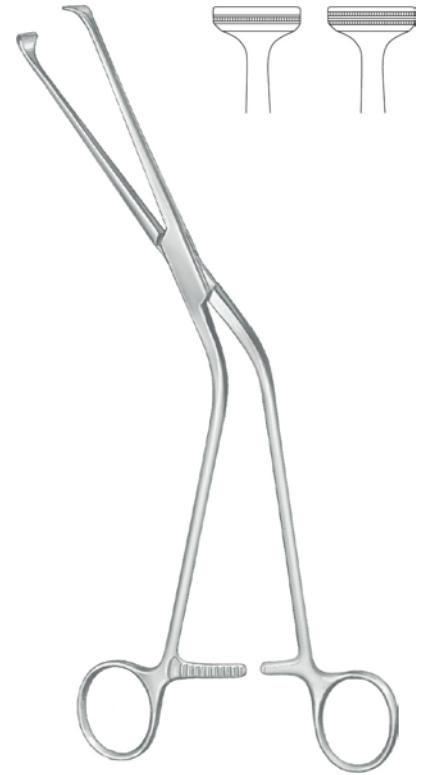

MILLIN

22.0 cm **GD28.127.23**



MILLIN

22.0 cm **GD28.123.23**

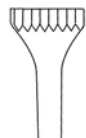

Lobe Holding Forceps  
 Fassung für vordere Lappen  
 Pince pour saisir les lobes  
 Pinza para lóbulos anteriores  
 Pinza per lobuli anteriori

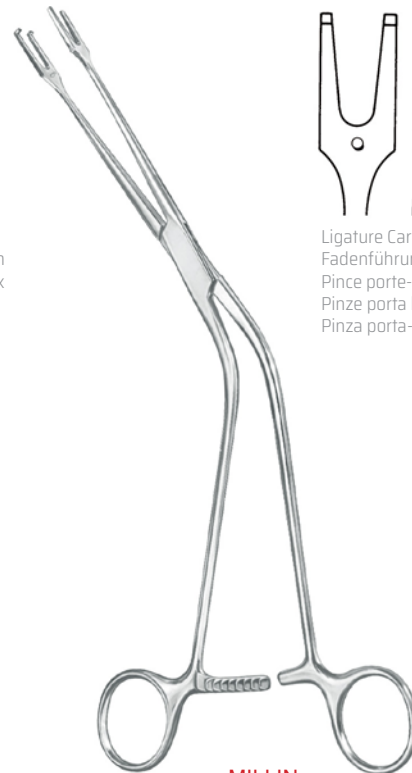

MILLIN

24.5 cm **GD28.125.24**

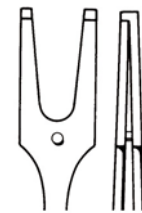

Ligature Carrying Forceps  
 Fadenführungszange  
 Pince porte-fil  
 Pinze porta ligaduras  
 Pinza porta-filo



Bladder Retractors, Bladder Spatula  
Blasenwundsperrer, Blasenspatel  
Ecarteurs vésicaux, Spatule vésicale  
Separadores vesicales, Espátula vesical  
Divaricatore vesicale, Spatole vescicali

**GRAND**  
DEVICES  
*The Grand Instruments Company*



35 mm

**LEGUEU**

27.0 cm **GD28.147.27**



67 mm

**KOCHER**

26.0 cm **GD28.149.27**

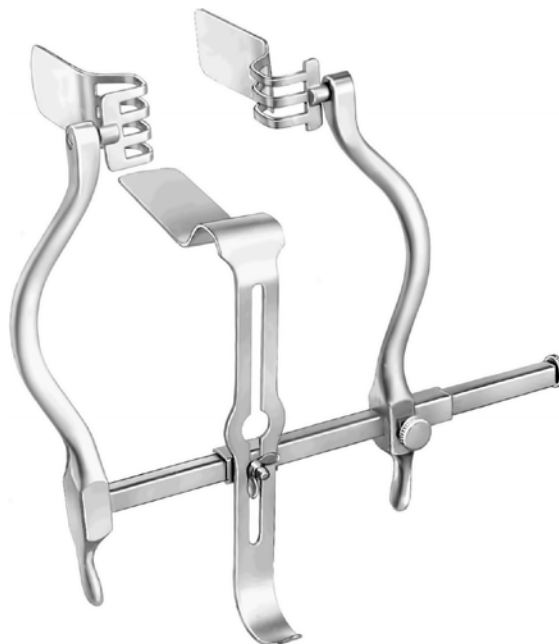

**JUDD-MASSON**

**GD28.150.00**



MILLIN

**MILLIN  
 GD28.151.00**

Complete with 2 pairs of lateral  
 Blades 57 x 25 mm and 80 x 25 mm  
 and 1 central blade 120 x 45 mm  
 without F.O. Carrier

komplett mit je 2 Seitenvalven  
 57 x 25 mm und 80 x 25 mm,  
 sowie 1 Mittelvalve 120 x 45 mm  
 ohne Kaltlichtaufsatz

complet, avec 2 paires de valves laterales,  
 57 x 25 mm et 80 x 25 mm,  
 ainsi qu'une valve centrale 120 x 45 mm  
 sans support lumière froide

completo, con 2 pares de valvas laterales  
 57 x 25 mm y 80 x 25 mm  
 y una valva central 120 x 45 mm  
 sin portador de luz fria

completo, con 2 paia di valve laterali  
 57 x 25 mm e 80 x 25 mm  
 in piú 1 valva centrale 120 x 45 mm  
 senza supporto per luce fredda

**MILLIN  
 GD28.151.50**

Complete with 2 pairs of lateral  
 Blades 57 x 25 mm and 80 x 25 mm  
 and 1 central blade 120 x 45 mm  
 with F.O. Carrier

komplett mit je 2 Seitenvalven  
 57 x 25 mm und 80 x 25 mm,  
 sowie 1 Mittelvalve 120 x 45 mm  
 mit Kaltlichtaufsatz

complet, avec 2 paires de valves laterales,  
 57 x 25 mm et 80 x 25 mm,  
 ainsi qu'une valve centrale 120 x 45 mm  
 avec support lumière froide

completo, con 2 pares de valvas laterales  
 57 x 25 mm y 80 x 25 mm  
 y una valva central 120 x 45 mm  
 con portador de luz fria

completo, con 2 paia di valve laterali  
 57 x 25 mm e 80 x 25 mm  
 in piú 1 valva centrale 120 x 45 mm  
 con supporto per luce fredda

**MILLIN  
 GD28.151.51**  
 F.O. Light Carrier  
 Kaltlichtaufsatz  
 Supporto lumière froide  
 Portador de luz fria  
 Supporto per luce fredda



Bladder Retractors  
Blasenwundsperrer  
Ecarteurs vésicaux  
Separadores vesicales  
Divaricatore vescicale

**GRAND**  
DEVICES  
*The Grand Instruments Company*



Complete with  
2 pairs of lateral blades  
1 central blade and  
1 retractor

komplett mit  
2 Paar Seitenvlaven,  
1 Mittelvalve und  
1 Retraktor

complet avec  
2 paires de valves laterales  
1 valve centrale  
1 écarteur

completo con  
2 pares de valvas laterales  
1 valva central  
1 separador

completo con  
2 paia di valve laterali  
1 valva centrale e  
1 retrattore

**THOMSON-WALKER**  
**GD28.160.00**

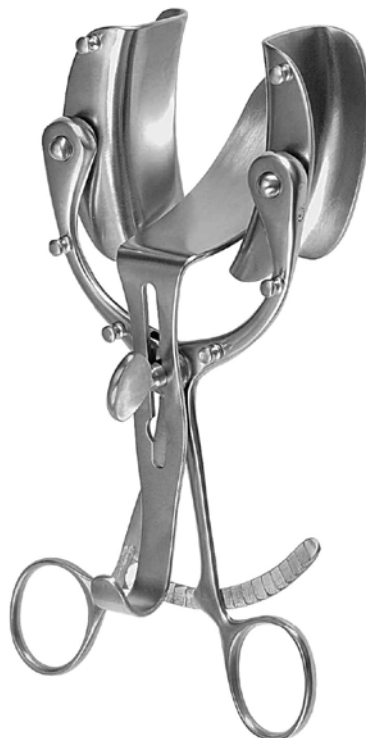

**LEGUEU**  
**GD28.163.00**

Gall Stone Scoops  
 Gallensteinlöffel  
 Curettes pour calculs biliaries  
 Cucharas para cálculos biliaries  
 Pinze per calcoli biliari



**MILLIN**

29.0 cm **GD28.165.00**



Foreign Body Forceps  
 Fremdkörperzangen  
 Pinceps à corps étrangers  
 Pinzas para cuerpos extranjerios  
 Pinze per corpi estranei



**MATHIEU**  
**GD28.168.20**  
 Length of shaft 20 cm  
 Schaftlänge 20 cm  
 longueur du tige 20 cm  
 longitud del vástago 20 cm  
 lunghezza del gambo 20 cm

**MATHIEU**  
**GD28.168.28**  
 Length of shaft 28 cm  
 Schaftlänge 28 cm  
 longueur du tige 28 cm  
 longitud del vástago 28 cm  
 lunghezza del gambo 28 cm





Urethrotom  
Urethrotome  
Urétrotome  
Uretrótomo  
Uretrotomi

**GRAND**  
DEVICES  
*The Grand Instruments Company*

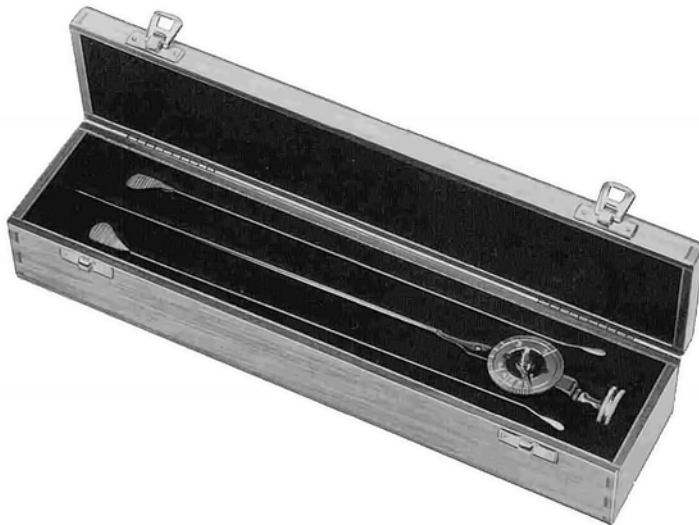
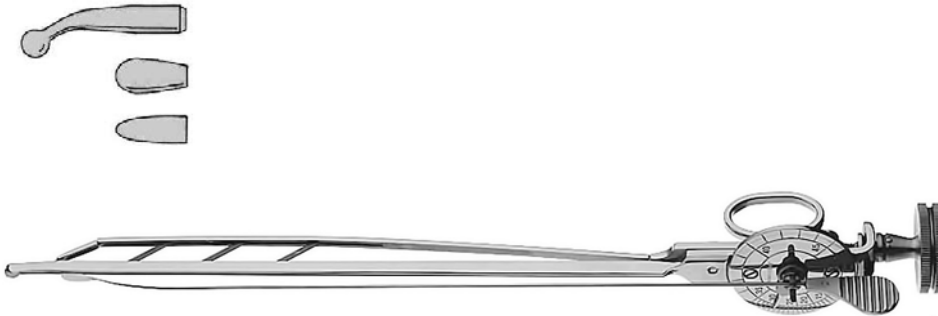

**OTIS**  
**GD28.169.00**

complete in wooden case  
with dilator, 2 knives and 3 tips

komplett mit Holzetui  
mit Dilitator, 2 Messern und 3 Ansätzen

complet, en boîte métal  
avec dilatateur, 2 lames et 3 embouts

completo an caja de madera  
con dilatador, 2 cuchillos y 3 puntas

completo, in contenitore di legno  
con dilatatore, 2 bisturi e 3 punte



**OTIS**  
**GD28.169.01**

Spare Blade  
Ersatmesser  
Couteau de rechange  
Cuchillo de repuesto  
Lama die ricambio

Urethrography- and Circumcision Instruments  
 Urethrographie- und Circumcisions-Instrumente  
 Instruments pour urétrographie et circoncision  
 Instrumentos para uretrografia y circuncisión  
 Strumenti per uretrografia e circoncisione



Circumcision Instrument  
 Circumcisionsgerät  
 Instrument de circoncision  
 Instrumento para circuncisión  
 Strumento per circoncisione



**66.171.08** Ø 8.0 mm  
**66.171.11** Ø 11.0 mm  
**66.171.13** Ø 13.0 mm  
**66.171.14** Ø 14.5 mm  
**66.171.16** Ø 16.0 mm  
**66.171.21** Ø 21.0 mm  
**66.171.26** Ø 26.0 mm  
**66.171.32** Ø 32.0 mm

Urethrography Instrument  
 Urethrographieinstrument  
 Instrument pour urétrographie  
 Instrumento para uretrografia  
 Strumento per uretrografia



**GD28.172.01**

**KNUTSON-KOCH**

**GD28.172.01**

Cone  
 Konus  
 Cône  
 Cono  
 Cono

**KNUTSON**  
**GD28.172.00**

Circumcision Instrument  
 Circumcisionsgerät  
 Instrument de circoncision  
 Instrumento para circuncisión  
 Strumento per circoncisione



**MOGAN**

**GD28.174.01**  
 for adults  
 für Erwachsene  
 pour adultes  
 para adultos  
 per adulti

**MOGAN**

**GD28.174.02**  
 for children  
 für Kinder  
 pour enfants  
 para niños  
 per bambini

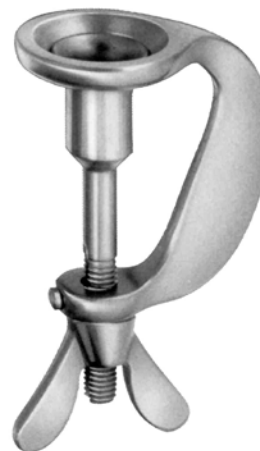

**WINKELMANN**

Ø 12 mm **GD28.1GD28.12**  
 Ø 16 mm **GD28.1GD28.16**  
 Ø 20 mm **GD28.1GD28.20**



Urological Instruments  
Urologie-Instrumente  
Instruments pour l'urologie  
Instrumental para urologia  
Strumenti per l'urologia

**GRAND**  
DEVICES  
*The Grand Instruments Company*

Meatus Clamps  
Penisklemmen  
Compresseurs de l'urètre  
Compressores uretrales  
Serrapene



**STOCKMANN**

8.0 cm **GD28.175.08**



**STRAUSS**

11.0 cm **GD28.177.11**



12.5 cm **GD28.179.12**

Forceps for grasping the glans and the foreskin  
Zange zum Erfassen der Glans und der Vorhaut



14.5 cm **GD28.179.15**

Fixation clamp for the spermatic cord  
Klemme zum Fixieren des Samenstranges  
Pince pour fixer le cordon  
Pinza para fijar el cordón espermático  
Pinza per fissare il tronco spermatico

Secretions Scoops, Catheter Introducer  
 Sekretlöffel, Katheterspanner  
 Cuiller à sécrétions, Introducteur de sondes  
 Cucharillas p. secreciones, Introducer de catéres  
 Cucchia per secrezioni, mandrini per sonde uretrali



GUTTMANN

26.5 cm GD28.180.26



DITTEL

46.0 cm GD28.182.46



GUYON

46.0 cm GD28.183.46



GUYON

39.0 cm GD28.184.39

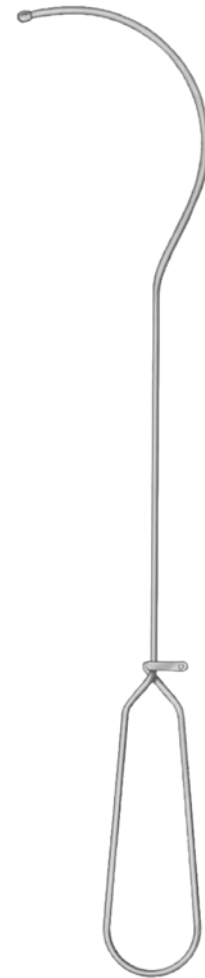

GUYON

35.0 cm GD28.185.35



Urethral Sounds  
Harnröhrenbougies  
Bougies urétrales  
Bujias uretrales  
Candelette dilatatrici

**GRAND**  
DEVICES  
*The Grand Instruments Company*

with screw thread  
mit Schraubgewinde-Ansatz  
avec ambout fileté  
con rosca de tornillo  
con attacco filettato

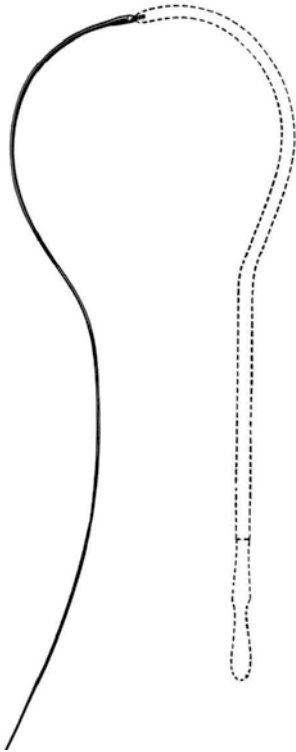

**FILIFORM**

3 Ch. **GD28.199.03**  
4 Ch. **GD28.199.04**  
5 Ch. **GD28.199.05**  
6 Ch. **GD28.199.06**

set with 21 bougies, Charr. 10 to 30  
with 4 filiform bougies  
in metal case 42 x 17,5 x 4 cm

Satz mit 21 Bougies, Charr. 10 bis 30  
mit 4 Gleitsonden  
im Metalltui 42 x 17,5 x 4 cm

jeu avec 21 bougies, Charr. 10 jusqu' à 30  
avec 4 bougies conductrices  
en boîte métal 42 x 17,5 x 4 cm

juego de 21 bujias, Charr. 10 a 30  
con 4 bujias filiformes  
en caja metálica 42 x 17,5 x 4 cm

set di 21 dilatatori, Charr. 10 fino a 30  
con 4 candelette dilatatrici  
in contenitore metallico 42 x 17,5 x 4 cm



**GUYON**

Compl. **GD28.200.00**



van BUREN	mm Ø	Charrière (French)
GD28.201.06	2	6
GD28.201.08	2 <sup>2/3</sup>	8
GD28.201.10	3 <sup>1/3</sup>	10
GD28.201.12	4	12
GD28.201.14	4 <sup>2/3</sup>	14
GD28.201.16	5 <sup>1/3</sup>	16
GD28.201.18	6	18
GD28.201.20	6 <sup>2/3</sup>	20
GD28.201.22	7 <sup>1/3</sup>	22
GD28.201.24	8	24
GD28.201.26	8 <sup>2/3</sup>	26
GD28.201.28	9 <sup>1/3</sup>	28
GD28.201.30	10	30
GD28.201.32	10 <sup>2/3</sup>	32
GD28.201.34	11 <sup>1/3</sup>	34
GD28.201.36	12	36
GD28.201.38	12 <sup>2/3</sup>	38

van BUREN

Set compl. **GD28.201.00**  
8-36 Charr.



Urethral Sounds  
Harnröhrenbougies  
Bougies urétrales  
Bujias uretrales  
Candelette dilatatrici

**GRAND**  
DEVICES  
The Grand Instruments Company

with screw thread  
mit Schraubgewinde-Ansatz  
avec ambout fileté  
con rosca de tornillo  
con attacco filettato



**GUYON**

Set compl. **GD28.203.00**  
10-30 Charr.

GUYON	mm Ø	Charrière (French)
GD28.203.10	3 <sup>1/3</sup>	10
GD28.203.11	3 <sup>2/3</sup>	11
GD28.203.12	4	12
GD28.203.13	4 <sup>1/3</sup>	13
GD28.203.14	4 <sup>2/3</sup>	14
GD28.203.15	5	15
GD28.203.16	5 <sup>1/3</sup>	16
GD28.203.17	5 <sup>2/3</sup>	17
GD28.203.18	6	18
GD28.203.19	6 <sup>1/3</sup>	19
GD28.203.20	6 <sup>2/3</sup>	20
GD28.203.21	7	21
GD28.203.22	7 <sup>1/3</sup>	22
GD28.203.23	7 <sup>2/3</sup>	23
GD28.203.24	8	24
GD28.203.25	8 <sup>1/3</sup>	25
GD28.203.26	8 <sup>2/3</sup>	26
GD28.203.27	9	27
GD28.203.28	9 <sup>1/3</sup>	28
GD28.203.29	9 <sup>2/3</sup>	29
GD28.203.30	10	30





GUYON

GUYON	mm Ø	Charrière (French)
GD28.205.08	2 <sup>2/3</sup>	8
GD28.205.09	3	9
GD28.205.10	3 <sup>1/3</sup>	10
GD28.205.11	3 <sup>2/3</sup>	11
GD28.205.12	4	12
GD28.205.13	4 <sup>1/3</sup>	13
GD28.205.14	4 <sup>2/3</sup>	14
GD28.205.15	5	15
GD28.205.16	5 <sup>1/3</sup>	16
GD28.205.17	5 <sup>2/3</sup>	17
GD28.205.18	6	18
GD28.205.19	6 <sup>1/3</sup>	19
GD28.205.20	6 <sup>2/3</sup>	20
GD28.205.21	7	21
GD28.205.22	7 <sup>1/3</sup>	22
GD28.205.23	7 <sup>2/3</sup>	23
GD28.205.24	8	24
GD28.205.25	8 <sup>1/3</sup>	25
GD28.205.26	8 <sup>2/3</sup>	26
GD28.205.27	9	27
GD28.205.28	9 <sup>1/3</sup>	28
GD28.205.29	9 <sup>2/3</sup>	29
GD28.205.30	10	30
GD28.205.31	10 <sup>1/3</sup>	31
GD28.205.32	10 <sup>2/3</sup>	32
GD28.205.33	11	33
GD28.205.34	11 <sup>1/3</sup>	34
GD28.205.35	11 <sup>2/3</sup>	35
GD28.205.36	12	36
GD28.205.37	12 <sup>1/3</sup>	37
GD28.205.38	12 <sup>2/3</sup>	38
GD28.205.39	13	39
GD28.205.40	13 <sup>1/3</sup>	40
GD28.205.50	16 <sup>2/3</sup>	50



Metal Catheters  
Metallkatheter  
Sondes métalliques  
Sondas metálicas  
Sonde metalliche

**GRAND**  
DEVICES  
The Grand Instruments Company

for men  
für Männer  
pour hommes  
para hombres  
per uomini



	mm Ø	Charrière (French)
<b>GD28.211.08</b>	2 <sup>2/3</sup>	8
<b>GD28.211.10</b>	3 <sup>1/3</sup>	10
<b>GD28.211.12</b>	4	12
<b>GD28.211.14</b>	4 <sup>2/3</sup>	14
<b>GD28.211.16</b>	5 <sup>1/3</sup>	16
<b>GD28.211.18</b>	6	18
<b>GD28.211.20</b>	6 <sup>2/3</sup>	20
<b>GD28.211.22</b>	7 <sup>1/3</sup>	22
<b>GD28.211.24</b>	8	24

for women  
für Frauen  
pour femmes  
para mujeres  
per donne



	mm Ø	Charrière (French)
<b>GD28.213.08</b>	2 <sup>2/3</sup>	8
<b>GD28.213.10</b>	3 <sup>1/3</sup>	10
<b>GD28.213.12</b>	4	12
<b>GD28.213.14</b>	4 <sup>2/3</sup>	14
<b>GD28.213.16</b>	5 <sup>1/3</sup>	16
<b>GD28.213.18</b>	6	18
<b>GD28.213.20</b>	6 <sup>2/3</sup>	20
<b>GD28.213.22</b>	7 <sup>1/3</sup>	22
<b>GD28.213.24</b>	8	24



	mm Ø	Charrière (French)
GD28.219.08	2 <sup>2/3</sup>	8
GD28.219.10	3 <sup>1/3</sup>	10
GD28.219.12	4	12
GD28.219.14	4 <sup>2/3</sup>	14
GD28.219.16	5 <sup>1/3</sup>	16
GD28.219.18	6	18
GD28.219.20	6 <sup>2/3</sup>	20
GD28.219.22	7 <sup>1/3</sup>	22
GD28.219.24	8	24



WALTHER

34.5 cm GD28.221.00

WALTHER	mm Ø	Charrière (French)
GD28.221.12	4	12
GD28.221.14	4 <sup>2/3</sup>	14
GD28.221.16	5 <sup>1/3</sup>	16
GD28.221.18	6	18
GD28.221.20	6 <sup>2/3</sup>	20
GD28.221.22	7 <sup>1/3</sup>	22
GD28.221.24	8	24
GD28.221.26	8 <sup>2/3</sup>	26
GD28.221.28	9 <sup>1/3</sup>	28
GD28.221.30	10	30
GD28.221.32	10 <sup>2/3</sup>	32
GD28.221.34	10 <sup>1/3</sup>	34
GD28.221.36	12	36
GD28.221.38	12 <sup>2/3</sup>	38

complete set  
Satz komplett  
jeu complet  
juego completo  
set completo

GD28.221.12 - GD28.221.38



Urethral Sounds  
Harnröhrenbougies  
Bougies urétrales  
Bujias uretrales  
Candelette dilatatrici

**GRAND**  
DEVICES  
The Grand Instruments Company



DITTEL	mm Ø	Charrière (French)
GD28.225.08	2 <sup>2/3</sup>	8
GD28.225.09	3	9
GD28.225.10	3 <sup>1/3</sup>	10
GD28.225.11	3 <sup>2/3</sup>	11
GD28.225.12	4	12
GD28.225.13	4 <sup>1/3</sup>	13
GD28.225.14	4 <sup>2/3</sup>	14
GD28.225.15	5	15
GD28.225.16	5 <sup>1/3</sup>	16
GD28.225.17	5 <sup>2/3</sup>	17
GD28.225.18	6	18
GD28.225.19	6 <sup>1/3</sup>	19
GD28.225.20	6 <sup>2/3</sup>	20
GD28.225.21	7	21
GD28.225.22	7 <sup>1/3</sup>	22
GD28.225.23	7 <sup>2/3</sup>	23
GD28.225.24	8	24
GD28.225.25	8 <sup>1/3</sup>	25
GD28.225.26	8 <sup>2/3</sup>	26
GD28.225.27	9	27
GD28.225.28	9 <sup>1/3</sup>	28
GD28.225.29	9 <sup>2/3</sup>	29
GD28.225.30	10	30
GD28.225.32	10 <sup>2/3</sup>	32

**DITTEL**

**GD28.225.00**

complete set (23)  
Satz komplett (23)  
jeu complet (23)  
juego completo (23)  
set completo (23)

**GD28.225.08 - GD28.225.30**

**DITTEL**

**GD28.225.98**

complete set (6)  
Satz komplett (6)  
jeu complet (6)  
juego completo (6)  
set completo (6)

**GD28.225.08/12/16/20/24/30**



**DITTEL**  
34.5 cm

<b>DITTEL</b>	<b>mm Ø</b>	<b>Charrière (French)</b>
<b>GD28.227.08</b>	<b>2<sup>2/3</sup></b>	<b>8</b>
<b>GD28.227.09</b>	<b>3</b>	<b>9</b>
<b>GD28.227.10</b>	<b>3<sup>1/3</sup></b>	<b>10</b>
<b>GD28.227.11</b>	<b>3<sup>2/3</sup></b>	<b>11</b>
<b>GD28.227.12</b>	<b>4</b>	<b>12</b>
<b>GD28.227.13</b>	<b>4<sup>1/3</sup></b>	<b>13</b>
<b>GD28.227.14</b>	<b>4<sup>2/3</sup></b>	<b>14</b>
<b>GD28.227.15</b>	<b>5</b>	<b>15</b>
<b>GD28.227.16</b>	<b>5<sup>1/3</sup></b>	<b>16</b>
<b>GD28.227.17</b>	<b>5<sup>2/3</sup></b>	<b>17</b>
<b>GD28.227.18</b>	<b>6</b>	<b>18</b>
<b>GD28.227.19</b>	<b>6<sup>1/3</sup></b>	<b>19</b>
<b>GD28.227.20</b>	<b>6<sup>2/3</sup></b>	<b>20</b>
<b>GD28.227.21</b>	<b>7</b>	<b>21</b>
<b>GD28.227.22</b>	<b>7<sup>1/3</sup></b>	<b>22</b>
<b>GD28.227.23</b>	<b>7<sup>2/3</sup></b>	<b>23</b>
<b>GD28.227.24</b>	<b>8</b>	<b>24</b>
<b>GD28.227.25</b>	<b>8<sup>1/3</sup></b>	<b>25</b>
<b>GD28.227.26</b>	<b>8<sup>2/3</sup></b>	<b>26</b>
<b>GD28.227.27</b>	<b>9</b>	<b>27</b>
<b>GD28.227.28</b>	<b>9<sup>1/3</sup></b>	<b>28</b>
<b>GD28.227.29</b>	<b>9<sup>2/3</sup></b>	<b>29</b>
<b>GD28.227.30</b>	<b>10</b>	<b>30</b>



Rectum  
Mastdarm  
Rectum  
Recto  
Retto  
直肠



**GD**29





Rectum  
Mastdarm  
Rectum  
Recto  
Retto

**GRAND**  
DEVICES  
*The Grand Instruments Company*

Rectal Specula  
Mastdarm-Spekula  
Spéculums rectaux  
Espéculos rectales  
Specoli rettali



**CZERNY**

22.0 cm **GD29.105.22**



**SIMS**

15.0 cm **GD29.110.15**



**BODENHAMMER**

15.0 cm **GD29.115.15**

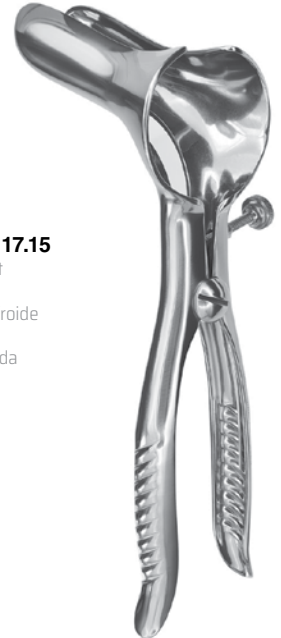

**PRATT**

**GD29.121.00**

**GD29.117.15**

Cold Light  
Kaltlicht  
Lumière froide  
Luz fria  
Luce fredda



**BARR**

70 x 22 mm **GD29.125.17**  
17 cm



**MATHIEU**

22.0 cm **GD29.130.19**



Anal Retractors  
Mastdarm-Spreizer  
Dilateurs p. anus et rectum  
Speculadores rectales  
Dilatatori per l'ano e il retto

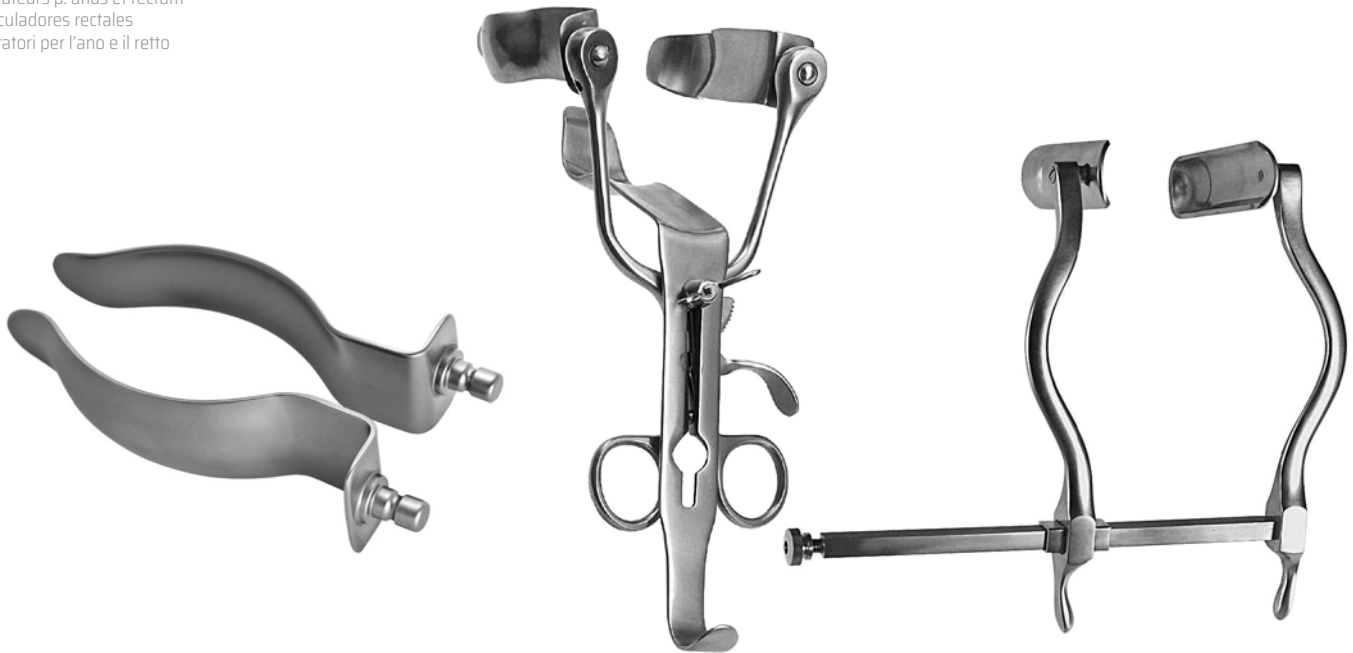

**ALAN-PARKS**

compl. **GD29.147.00**  
13.5 cm

**SMITH-BUIE**

75 x 23mm **GD29.150.15**  
15.0 cm

**GD29.148.00**

Cold Light Attachment for  
Kaltlicht-Adapter für  
Adaptateur lumière froide pour  
Adaptador luz fría para  
Adattatore luce fredda per

**GD29.147.00**  
**GD29.147.00**  
**GD29.147.00**  
**GD29.147.00**  
**GD29.147.00**

Rectoscope  
Rektoskop  
Rectoscope  
Rectoscopio  
Rettoscopio

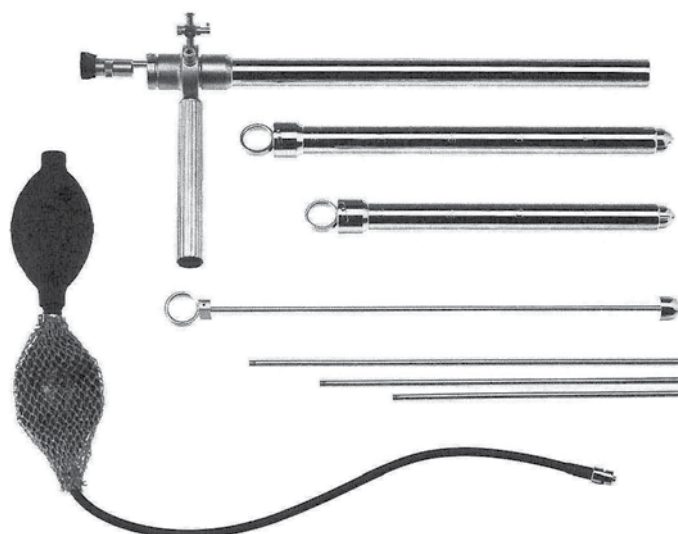

compl. **GD29.161.00**

Cold Light • Kaltlicht • Lumière froide  
Luz fría • Luce fredda



Rectum  
Mastdarm  
Rectum  
Recto  
Retto

**GRAND**  
DEVICES  
*The Grand Instruments Company*

Anoscopes, Proctoscopes  
Anoskope, Proktoskope  
Anoscopes, Proctoscopes  
Anoscopios, Proctoscopios  
Anoscopi, Proctoscopi



**IVES-FANSLER**

22.0 mm Ø **GD29.210.22**  
L= 80 mm



**HIRSCHMANN**

16.0 mm Ø **GD29.212.16**  
19.0 mm Ø **GD29.212.19**  
22.0 mm Ø **GD29.212.22**  
L= 65 mm



**KELLY**

Ø mm x L mm  
22 x 50 **GD29.220.05**  
22 x 100 **GD29.220.10**  
22 x 140 **GD29.220.14**  
22 x 200 **GD29.220.20**

Cystic Hooks  
Cystikus-Haken  
Ecarteurs rectaux  
Ganchos rectales  
Unicini rettali



**KELLY**

21.0 mm Ø **GD29.224.21**  
27.0 mm Ø **GD29.224.27**  
L= 50 mm



**GD29.251.01**  
Fig. 1

**GD29.251.02**  
Fig. 2

**GD29.251.03**  
Fig. 3

**PRATT**

**GD29.251.01 - GD29.251.03**



**BUIE**  
41.0 cm **GD29.261.41**

Biopsy Specimen Forceps  
Biopsie-Zangen  
Pincas emporte-pièce à biopsia  
Pinzas sacabocado para biopsia  
Pinza per biopsia



**WESTON**  
30.0 cm **GD29.263.30**

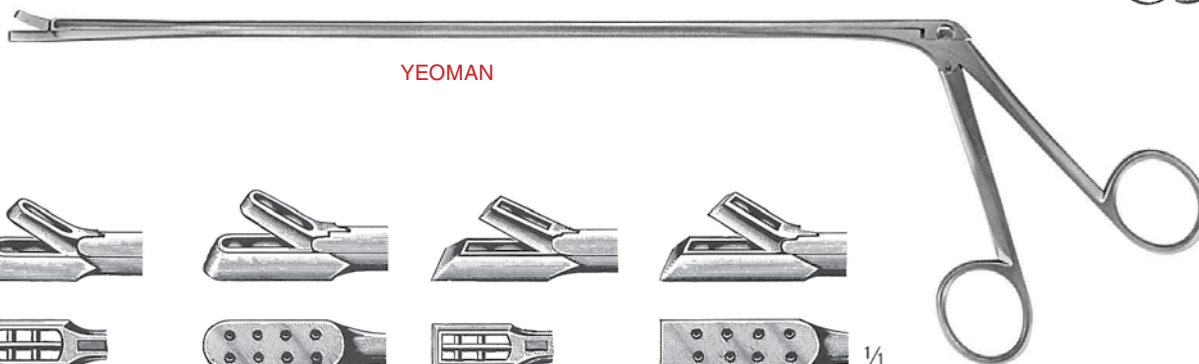

**YEOMAN**



Fig. 1

**GD29.301.28**  
**GD29.301.35**  
**GD29.301.42**



Fig. 2

**GD29.302.28**  
**GD29.302.35**  
**GD29.302.42**



Fig. 3

**GD29.303.28**  
**GD29.303.35**  
**GD29.303.42**



Fig. 4

**GD29.304.28**  
**GD29.304.35**  
**GD29.304.42**

28.0 cm  
35.0 cm  
42.0 cm

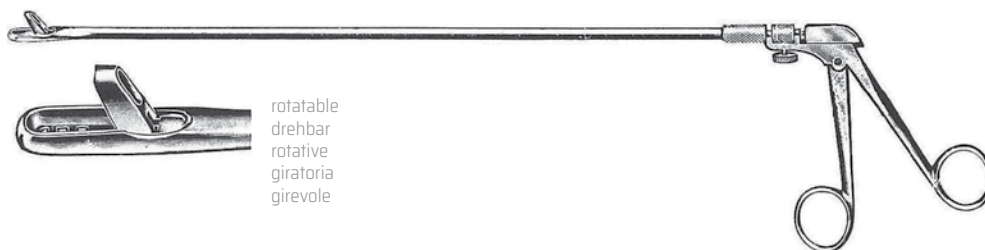

rotatable  
drehbar  
rotative  
giratoria  
girevole

**YEOMAN**

23.0 cm **GD29.311.23**  
33.0 cm **GD29.311.33**  
40.0 cm **GD29.311.40**



rotatable  
drehbar  
rotative  
giratoria  
girevole

**TURREL**

23.0 cm **GD29.321.23**  
33.0 cm **GD29.321.33**  
40.0 cm **GD29.321.40**

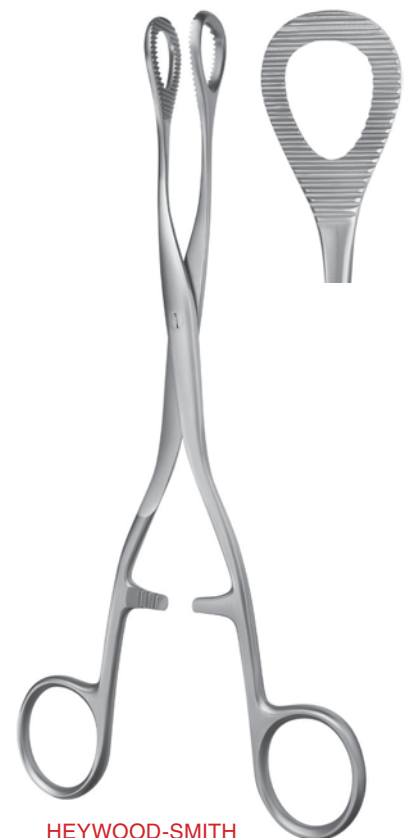

**HEYWOOD-SMITH**

21.0 cm **GD29.402.21**



Tonsils  
Tonsillen  
Amygdales  
Amígdalas  
Tonsille  
扁桃體



**GD30**



Tonsils  
Tonsillen  
Amygdales  
Amígdalas  
Tonsille

**GRAND**  
DEVICES  
The Grand Instruments Company



LOVE

18.0 cm **GD30.103.18**  
20.0 cm **GD30.103.20**  
22.0 cm **GD30.103.22**



HOFER

24.0 cm **GD30.109.24**



NAGER

23.0 cm **GD30.111.23**



HURD

<b>GD30.131.22</b>	<b>GD30.133.22</b>
smooth	serrated
glatt	gezahnt
liso	dentelé den-
liscio	tado
	dentellato
22.0 cm	23.0 cm

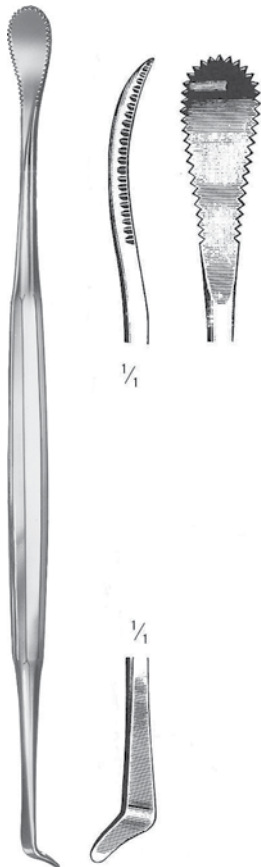

HENKE

23.0 cm **GD30.135.23**

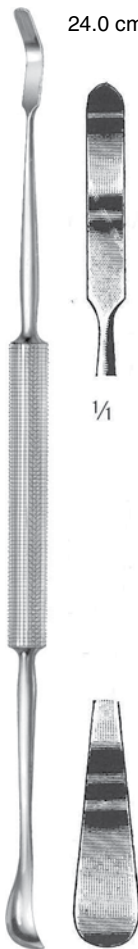

CARPENTER

25.0 cm **GD30.139.25**



CARPENTER

24.0 cm **GD30.143.24**



LUNIATSCHEK

19.0 cm **GD30.151.19**





DUPUY-WEISS

GD30.165.22 22.0 cm GD30.167.22

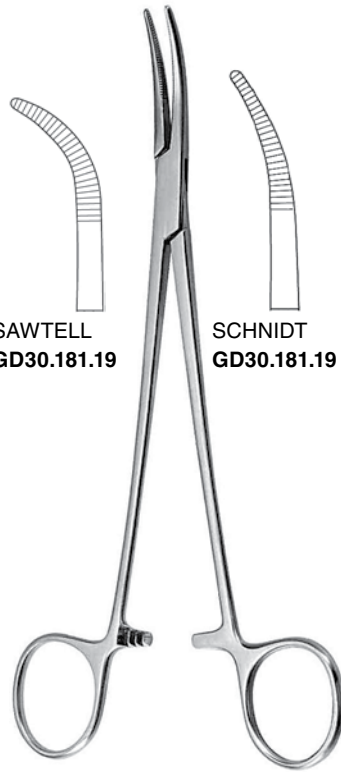

SAWTELL  
GD30.181.19

SCHNIDT  
GD30.181.19

GD30.181.19 19.0 cm GD30.183.19

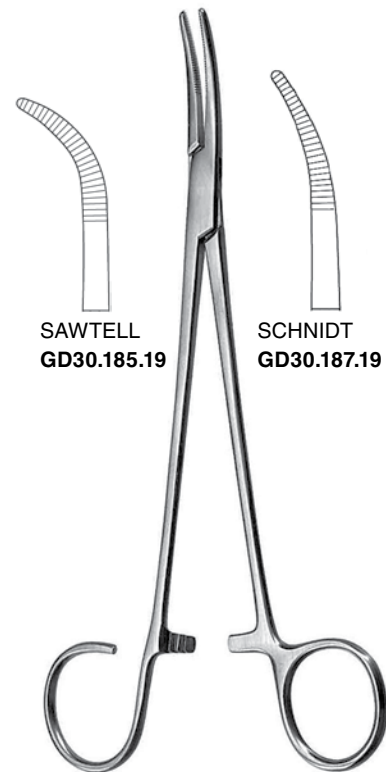

SAWTELL  
GD30.185.19

SCHNIDT  
GD30.187.19

GD30.185.19 19.0 cm GD30.187.19

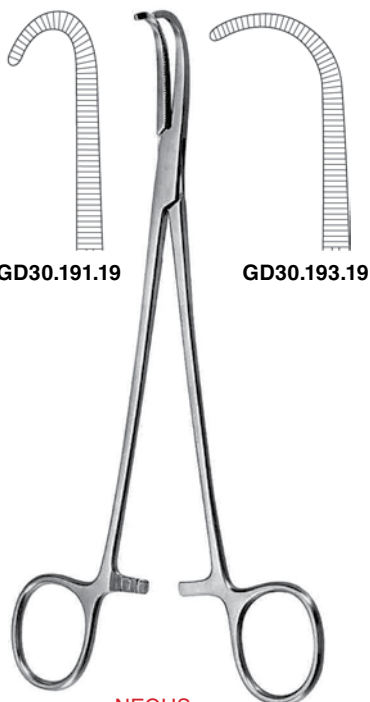

GD30.191.19

GD30.193.19

NEGUS  
GD30.191.19 19.0 cm GD30.193.19



1/4  
GD30.202.19

GD30.203.19

COLVER  
GD30.202.19 19.0 cm GD30.203.19



WHITE  
18.0 cm GD30.205.18  
23.0 cm GD30.205.23



Tonsils  
Tonsillen  
Amygdales  
Amígdalas  
Tonsille

**GRAND**  
DEVICES  
The Grand Instruments Company



**BALLENGER**  
21.5 cm **GD30.207.21**



**BLOHMKE**  
20.0 cm **GD30.209.20**

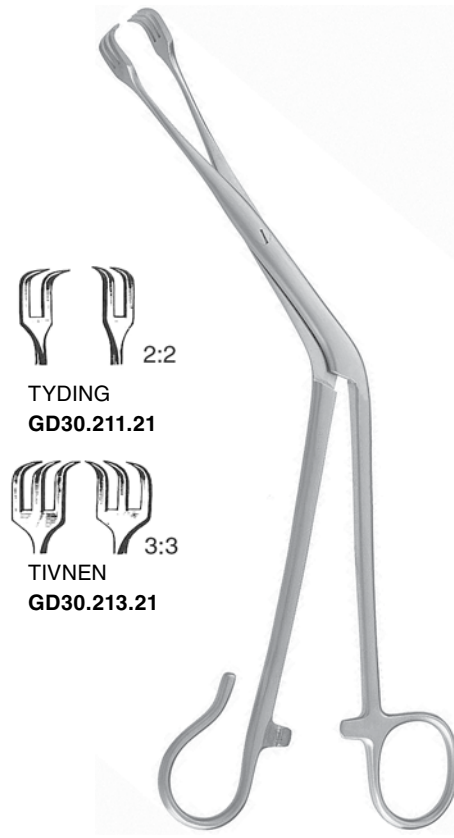

**TYDING**  
**GD30.211.21**



**TIVNEN**  
**GD30.213.21**

**GD30.211.21 21.0 cm GD30.213.21**



**MARSCHIK**  
22.0 cm **GD30.219.22**



28.0 cm **GD30.250.28**



28.0 cm **GD30.252.28**



28.0 cm **GD30.256.28**

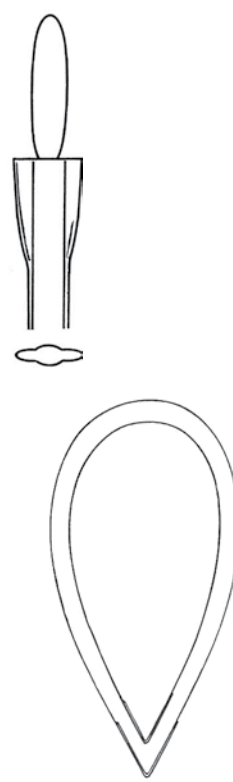

40 mm **GD30.257.40**  
50 mm **GD30.257.50**  
100 x



0.3 mm **GD30.259.03**  
12 x



**TYDING**

**GD30.260.00**

with 1 straight tip  
mit 1 geraden Aufsatz  
à 1 embout droit  
con 1 punta recta  
con 1 punta retta



**SLUDER-BALLENGER**

**GD30.270.00**

with 3 blades  
mit 3 Aufsätzen  
avec 3 lames  
con 3 hojas  
con 3 lame

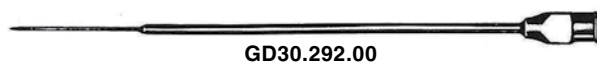

**GD30.292.00**

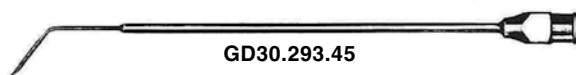

**GD30.293.45**  
45°

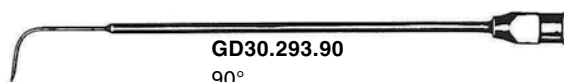

**GD30.293.90**  
90°



2.0 ml **GD30.290.02**

5.0 ml **GD30.290.05**

10 ml **GD30.290.10**



Larynx  
Kehlkopf  
Larynx  
Laringe  
Laringe  
喉



**GD31**



Larynx  
Kehlkopf  
Larynx  
Laringe

**GRAND**  
DEVICES  
*The Grand Instruments Company*



**JACKSON**

**GD31.101.22 - GD31.103.22**  
22.0 cm

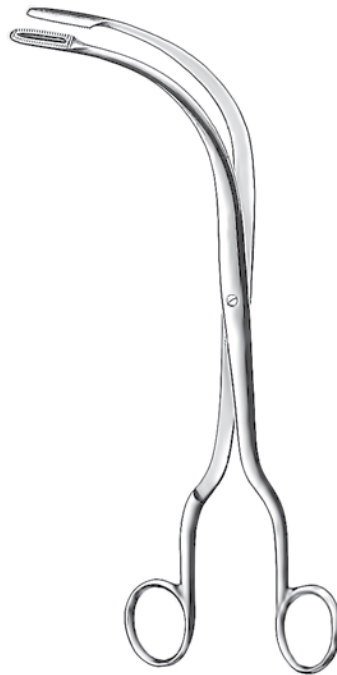

**FRAENKEL**

18.0 cm **GD31.111.18**



**GD31.115.01**  
Fig. 1



**GD31.115.02**  
Fig. 2



**GD31.115.03**  
Fig. 3



**GD31.115.04**  
Fig. 4

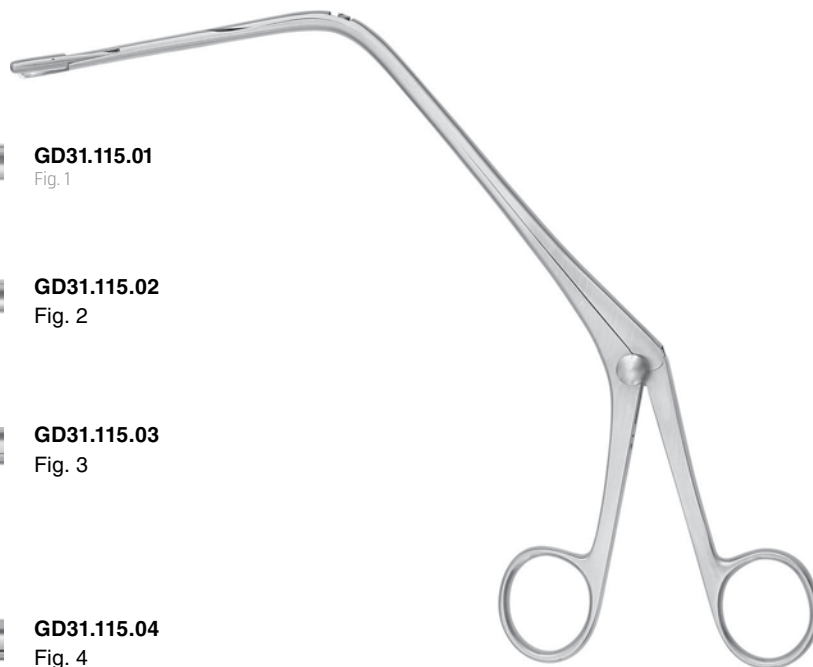

**JURASZ**

**GD31.115.01 - GD31.115.04**  
23 cm



**REICHERT**

24.0 cm **GD31.121.24**



**HUBER**  
GD31.130.00



**BRUENINGS**

- 20 cm **GD31.132.20**
- 30 cm **GD31.132.30**
- 40 cm **GD31.132.40**
- 50 cm **GD31.132.50**
- 60 cm **GD31.132.60**

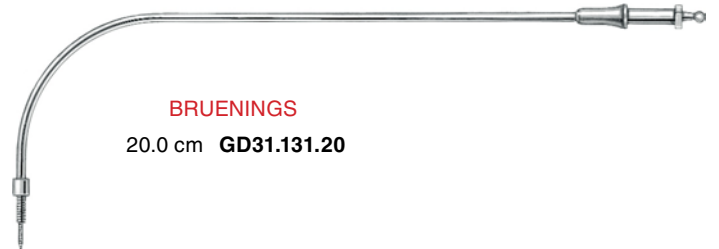

**BRUENINGS**

- 20.0 cm **GD31.131.20**



**FRAENKEL**  
GD31.150.00



**SEIFERT**  
GD31.152.00



**FRAENKEL**  
GD31.154.00



**SCHEINMANN**  
GD31.155.00

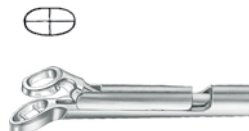

**SCHEINMANN**  
GD31.157.00



**BRUENINGS**  
GD31.158.02 - GD31.158.03



**BRUENINGS**  
GD31.160.02 - GD31.160.03

- GD31.158.02
- GD31.158.03

- GD31.160.02
- GD31.160.03



**LANGE**  
GD31.162.00

- ⊕ GD31.164.01
- ⊕ GD31.164.02



**KRAUSE**  
GD31.164.01 - GD31.164.02



**KRAUSE**  
GD31.166.00

- ⊕ GD31.168.01
- ⊕ GD31.168.02
- ⊕ GD31.168.03
- ⊕ GD31.168.04



**CORDES**  
GD31.168.01 - GD31.168.04



**SCHUMACHER**  
GD31.170.00

- ⊕ GD31.172.01
- ⊕ GD31.172.02



**CORDES**  
GD31.172.01 - GD31.172.02



**CORDES**  
GD31.174.00



**ROSENBERG**  
GD31.176.00



Larynx  
Kehlkopf  
Larynx  
Laringe  
Laringe

**GRAND**  
DEVICES  
*The Grand Instruments Company*

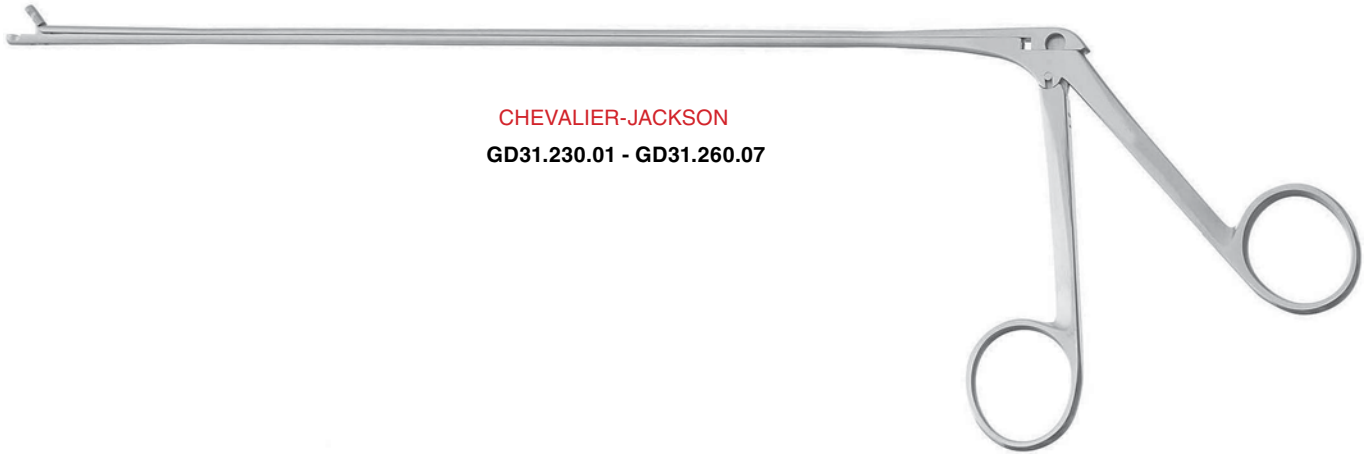

**CHEVALIER-JACKSON**

**GD31.230.01 - GD31.260.07**



**Fig. 1**

**Fig. 2**

**Fig. 3**

**Fig. 4**

**Fig. 5**

**Fig. 6**

**Fig. 7**

30 cm	<b>GD31.230.01</b>	<b>GD31.230.02</b>	<b>GD31.230.03</b>	<b>GD31.230.04</b>	<b>GD31.230.05</b>	<b>GD31.230.06</b>	<b>GD31.230.07</b>
40 cm	<b>GD31.240.01</b>	<b>GD31.240.02</b>	<b>GD31.240.03</b>	<b>GD31.240.04</b>	<b>GD31.240.05</b>	<b>GD31.240.06</b>	<b>GD31.240.07</b>
50 cm	<b>GD31.250.01</b>	<b>GD31.250.02</b>	<b>GD31.250.03</b>	<b>GD31.250.04</b>	<b>GD31.250.05</b>	<b>GD31.250.06</b>	<b>GD31.250.07</b>
60 cm	<b>GD31.260.01</b>	<b>GD31.260.02</b>	<b>GD31.260.03</b>	<b>GD31.260.04</b>	<b>GD31.260.05</b>	<b>GD31.260.06</b>	<b>GD31.260.07</b>

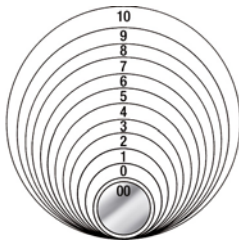

**Fig. 1** mm ø

<b>GD31.270.08</b>	00	8	<b>GD31.272.08</b>
<b>GD31.270.10</b>	0	10	<b>GD31.272.10</b>
<b>GD31.270.12</b>	1	12	<b>GD31.272.12</b>
<b>GD31.270.14</b>	2	14	<b>GD31.272.14</b>
<b>GD31.270.16</b>	3	16	<b>GD31.272.16</b>
<b>GD31.270.18</b>	4	18	<b>GD31.272.18</b>
<b>GD31.270.20</b>	5	20	<b>GD31.272.20</b>
<b>GD31.270.22</b>	6	22	<b>GD31.272.22</b>
<b>GD31.270.24</b>	7	24	<b>GD31.272.24</b>
<b>GD31.270.26</b>	8	26	<b>GD31.272.26</b>
<b>GD31.270.28</b>	9	28	<b>GD31.272.28</b>
<b>GD31.270.30</b>	10	30	<b>GD31.272.30</b>



**GD31.270.08 - GD31.270.30**

**GD31.272.08 - GD31.272.30**

**GD31.274.12**

**GD31.276.10**



Tracheostomy, Goitre  
Tracheotomie, Kropf  
Trachéotomie, Goitre  
Traqueotomía, Bocio  
Tracheotomia, Gozzo  
气管切开术·甲状腺肿



**GD32**



Tracheostomy  
 Tracheotomie  
 Trachéotomie  
 Traqueotomía  
 Tracheotomia

**GRAND**  
 DEVICES  
*The Grand Instruments Company*

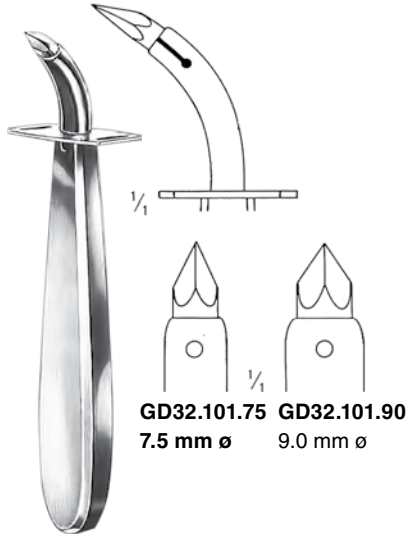

**WUCKERMANN**  
 GD32.101.75 13.0 cm GD32.101.90

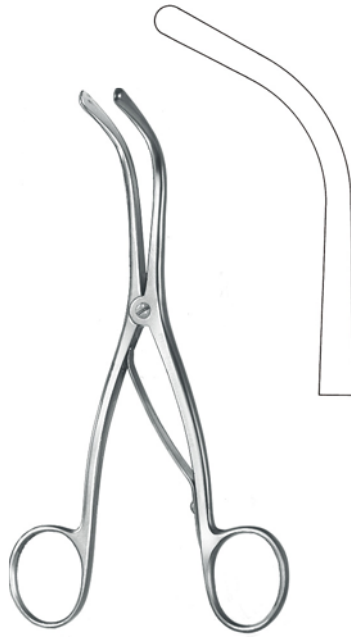

**TROUSSEAU**  
 14.0 cm GD32.111.14



**LABORDE**  
 14.0 cm GD32.113.14



**BOSE**  
 7.0 cm GD32.115.07



**JACKSON**  
 15.0 cm GD32.116.15



**JACKSON**  
 17.0 cm GD32.117.17 GD32.118.16



**ITERSON**  
 16.0 cm GD32.119.16



**BOSE**  
 16.0 cm GD32.122.16



**BOSE**  
 16.0 cm GD32.124.16

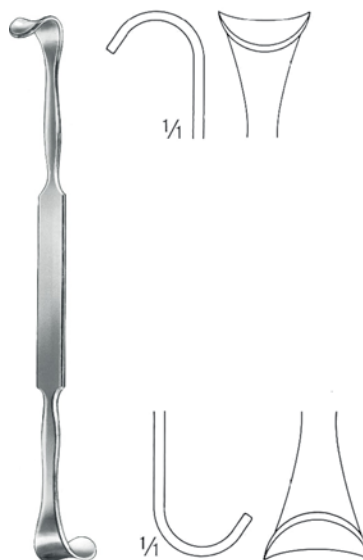

**ROSE**

13.0 cm **GD32.130.13**



**WAGENER-MOSHER**

5.0 mm **GD32.151.05**  
7.0 mm **GD32.151.07**  
9.0 mm **GD32.151.09**

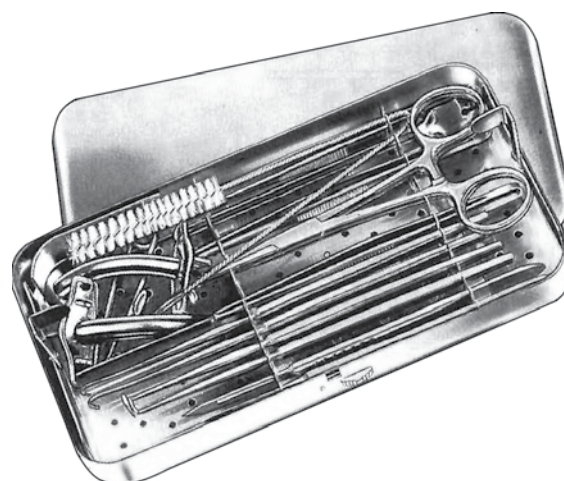

**GD32.270.00**



Fig. 1	mm	LUER
0	4	<b>GD32.220.04</b>
1	5	<b>GD32.220.05</b>
2	6	<b>GD32.220.06</b>
3	7	<b>GD32.220.07</b>
4	8	<b>GD32.220.08</b>
5	9	<b>GD32.220.09</b>
6	10	<b>GD32.220.10</b>
7	11	<b>GD32.220.11</b>
8	12	<b>GD32.220.12</b>
9	13	<b>GD32.220.13</b>



Fig. 1	mm	JACKSON
0	4	<b>GD32.240.04</b>
1	5	<b>GD32.240.05</b>
2	6	<b>GD32.240.06</b>
3	7	<b>GD32.240.07</b>
4	8	<b>GD32.240.08</b>
5	9	<b>GD32.240.09</b>
6	10	<b>GD32.240.10</b>
7	11	<b>GD32.240.11</b>
8	12	<b>GD32.240.12</b>
9	13	<b>GD32.240.13</b>



Tracheostomy  
Tracheotomie  
Trachéotomie  
Traqueotomía  
Tracheotomia

**GRAND**  
DEVICES  
*The Grand Instruments Company*



**KOCHER**

**GD32.501.15** 15.0 cm **GD32.503.15**



**SCHOENBORN**

21.0 cm **GD32.511.21**



**LAHEY**

15.0 cm **GD32.520.15**  
20.0 cm **GD32.520.20**



**MASTIN**

17.0 cm **GD32.523.17**

Plaster of Paris  
Gipsverband  
Bandages plâtrés  
Vendajes enyesados  
Bendaggi gessati  
巴黎的石膏



**GD33**



Plaster of Paris  
Gipsverband  
Appareils plâtrés  
Vendajes enyesados  
Bendaggi gessati

**GRAND**  
DEVICES  
*The Grand Instruments Company*

Plaster Shears  
Gipsscheren  
Ciseaux pour plâtre  
Cizallas para yeso  
Forbici per gesso



**STILLE**

24.0 cm **GD33.101.24**



**STILLE**

18.0 cm **GD33.103.18**  
20.0 cm **GD33.103.20**  
23.0 cm **GD33.103.23**  
26.0 cm **GD33.103.26**  
37.0 cm **GD33.103.37**



**SEUTIN**

23.0 cm **GD33.104.23**

Plaster Saws  
Gipssägen  
Scies pour plâtre  
Sierra para yeso  
Seghe per gesso



**WIGMORE**

19.0 cm **GD33.370.19**



**ENGEL**

**GD33.130.14**



**BERGMANN**

**GD33.134.18**



Plaster Spreaders  
Gipsspreizer  
Pince pour plâtre  
Separadores para yeso  
Pinze per gesso



**HENNIG**

28.0 cm **GD33.350.28**



**HERMANN**

48.0 cm **GD33.350.48**



**QUATTRO**

23.0 cm **GD33.352.23**



**BEESON**

30.0 cm **GD33.360.30**



**HAGLUND-STILLE**

28.0 cm **GD33.362.28**



23.0 cm **GD33.366.23**





Plaster of Paris  
Gipsverband  
Appareils plâtrés  
Vendajes enyesados  
Bendaggi gessati

**GRAND**  
DEVICES  
The Grand Instruments Company

Plaster Knives  
Gipsmesser  
Couteaux pour plâtre  
Cuchillos para yeso  
Coltelli per gesso



**HOPKINS**  
20.0 cm **GD33.370.20**



**ESMARCH**  
18.0 cm **GD33.380.18**



**REINER**  
18.0 cm **GD33.390.18**



**GIPS**  
21.0 cm **GD33.390.21**

Plaster Breakers  
Gipsabreißzangen  
Pince pour rompre plâtre  
Pinzas para romper yeso  
Pinze per rompere gesso



**WOLFF**  
18.0 cm **GD33.395.18**



**WOLFF**  
24.0 cm **GD33.397.24**





Fully adjustable  
 Stufenlos regelbar  
 Réglable sans arrêt  
 Regular con progresión  
 Regolabile con processione continua



**GD33.200.10**  
 110 Volt

**GD33.200.20**  
 230 Volt

complete with 2 saw blades GD33.210.50, GD33.210.65 and 2 wrenches GD33.210.02  
 komplett mit 2 Sägeblättern GD33.210.50, GD33.210.65 und 2 Schraubenschlüsseln GD33.210.02  
 complet avec 2 lames de scie GD33.210.50, GD33.210.65 et clé à écrou GD33.210.02  
 completo con 2 hojas de sierra GD33.210.50, GD33.210.65 y 2 llaves de tuercas GD33.210.02  
 completa con 2 lame GD33.210.50, GD33.210.65 e 2 chiavi GD33.210.02



**GD33.210.02**

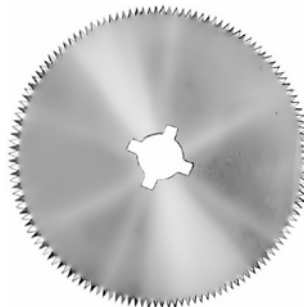

Circular saw blades  
 Kreissägeblätter  
 Lames de scie circulaires  
 Hojas de sierra circular  
 Lame circolari per fasciature

		Typ
45 mm Ø	<b>GD33.210.45</b>	normal
50 mm Ø	<b>GD33.210.50</b>	normal
65 mm Ø	<b>GD33.210.65</b>	normal
45 mm Ø	<b>GD33.211.45</b>	hart
50 mm Ø	<b>GD33.211.50</b>	hart
65 mm Ø	<b>GD33.211.65</b>	hart
50 mm Ø	<b>GD33.212.50</b>	Teflon
65 mm Ø	<b>GD33.212.65</b>	Teflon



Gynecology  
Gynäkologie  
Gynécologie  
Ginecología  
Ginecologia  
妇科

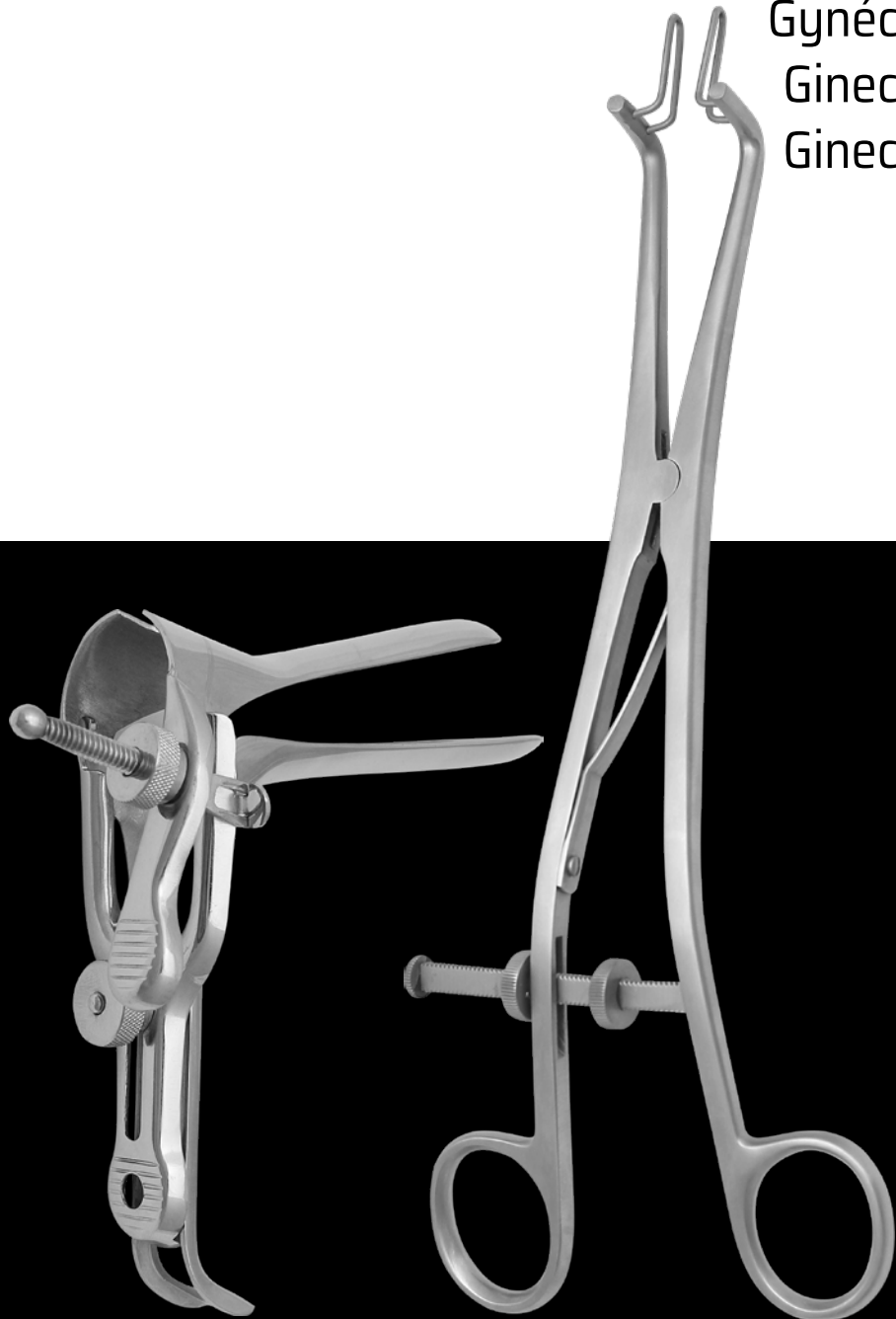

**GD**34



Vaginal Specula  
 Vaginalsepekula  
 Speculums vaginaux  
 Espéculos vaginales  
 Specoli vaginali

**GRAND**  
 DEVICES  
 The Grand Instruments Company



Fig.	mm	GRAVE	
		Standard	Laser Mod.
1	75 x 20	GD34.110.01	GD34.114.01
2	95 x 35	GD34.110.02	GD34.114.02
3	115 x 35	GD34.110.03	GD34.114.03



Fig.	mm	GRAVE	
		Standard	
2	95 x 35	GD34.111.02	

with suction  
 mit Absaugung  
 avec aspiration  
 con aspiradoras  
 con aspirazione

extra small  
 extra klein  
 extra petit  
 extra pequeno  
 extra piccolo



GRAVE  
 76 x 12 mm GD34.112.01

extra large  
 extra groß  
 extra grande  
 extra grande  
 extra grande



GRAVE  
 120 x 38 mm GD34.112.02



**PEDERSON**

Fig.	mm	Standard
1	75 x 13	<b>GD34.120.01</b>
2	100 x 22	<b>GD34.120.02</b>
3	120 x 25	<b>GD34.120.03</b>



**PEDERSON**

100 x 16 mm **GD34.122.10**



Vaginal Specula  
 Vaginalspekula  
 Speculums vaginaux  
 Espécules vaginales  
 Specoli vaginali

**GRAND**  
 DEVICES  
 The Grand Instruments Company



**COLLIN**  
 Fig. mm Standard  
 1 85 x 30 **GD34.130.01**  
 2 100 x 35 **GD34.130.02**  
 3 110 x 40 **GD34.130.03**



**COLLIN**  
 65 x 20 mm **GD34.131.00**



**COLLIN**  
 65 x 10 mm **GD34.132.00**



**CUSCO**  
 Fig. mm Standard Laser Mod.  
 0 85 x 24 **GD34.140.00**  
 1 75 x 32 **GD34.140.01**  
 2 85 x 35 **GD34.140.02** **GD34.144.02**  
 3 100 x 35 **GD34.140.03** **GD34.144.03**



**CUSCO**

65 x 20 mm **GD34.142.00**

Central Screw  
Mittelschraube  
Vis centrale  
Tornillo central  
Vite centrale



**CUSCO**

80 x 24 mm **GD34.150.00**  
75 x 32 mm **GD34.150.01**  
85 x 36 mm **GD34.150.02**  
95 x 37 mm **GD34.150.03**  
110 x 37 mm **GD34.150.04**  
75 x 17 mm **GD34.151.00**



Vaginal Specula  
Vaginalsepekula  
Speculums vaginaux  
Espécules vaginales  
Specoli vaginali

**GRAND**  
DEVICES  
*The Grand Instruments Company*

flache Entenschnabelform  
flat duck beak



**CUSCO**

80 x 32 mm **GD34.152.01**  
90 x 37 mm **GD34.152.02**  
115 x 37 mm **GD34.152.03**

Schweizer Modell  
Swiss Pattern  
Modèle suisse  
Modelo suizo  
Modello svizzero



**CUSCO**

Fig.	mm	Standard
1	90 x 23-25	<b>GD34.160.01</b>
2	100 x 25-27	<b>GD34.160.02</b>
3	110 x 27-30	<b>GD34.160.03</b>



**FREEWAY GRAVE**

100 x 32 mm **GD34.162.01**



**FREEWAY GRAVE**

45° **GD34.162.02**



Vaginal Specula  
Vaginalspekula  
Speculums vaginaux  
Espéculos vaginales  
Specoli vaginali



**TRELAT**

85 x 33 mm **GD34.180.01**  
95 x 35 mm **GD34.180.02**  
115 x 43 mm **GD34.180.03**



**SEMM**

90 x 14-18 mm **GD34.190.01**  
100 x 17-20 mm **GD34.190.02**  
100 x 25-30 mm **GD34.190.03**



Vaginal Specula, Vaginal Retractors  
Vaginalspekula, Scheidenhalter  
Speculums vaginaux, Velves vaginales  
Espéculos vaginales, Valvas vaginales  
Specoli vaginali, Valve vaginali

**GRAND**  
DEVICES  
*The Grand Instruments Company*



**O'SULLIVAN O'CONNOR**

complete **GD34.196.00**  
komplett  
complet  
completo  
completo



**GD34.196.01**  
45 x 17 mm  
Fig. 1

**GD34.196.02**  
90 x 37 mm  
Fig. 2

**GD34.196.03**  
90 x 45 mm  
Fig. 3

Vaginal Specula, Vaginal Retractors  
 Vaginalspekula, Scheidenhalter  
 Speculums vaginaux, Velves vaginales  
 Espécules vaginales, Valvas vaginales  
 Specoli vaginali, Valve vaginali



set no. consisting of  
 Satz Fig. bestehend aus  
 jeu no. se compostant de  
 juego no. consiste de  
 serie no. composto da

**KRISTELLER**

Fig. 0	<b>GD34.210.01</b>	<b>GD34.211.00 + GD34.212.00</b>
Fig. 1	<b>GD34.210.02</b>	<b>GD34.211.01 + GD34.212.01</b>
Fig. 2	<b>GD34.210.03</b>	<b>GD34.211.02 + GD34.212.02</b>
Fig. 3	<b>GD34.210.04</b>	<b>GD34.211.03 + GD34.212.03</b>



Speculum  
 Spekulum  
 Spéculum  
 Espéculo  
 Specolo

**KRISTELLER**

Fig. 0	70 x 15 mm	<b>GD34.211.00</b>
Fig. 1	70 x 27 mm	<b>GD34.211.01</b>
Fig. 2	80 x 30 mm	<b>GD34.211.02</b>
Fig. 3	90 x 36 mm	<b>GD34.211.03</b>



Retractor  
 Halter  
 Valve  
 Valva

**KRISTELLER**

Fig. 0	75 x 10 mm	<b>GD34.212.00</b>
Fig. 1	75 x 23 mm	<b>GD34.212.01</b>
Fig. 2	85 x 26 mm	<b>GD34.212.02</b>
Fig. 3	100 x 32 mm	<b>GD34.212.03</b>



Vaginal Specula, Vaginal Retractors  
Vaginalspekula, Scheidenhalter  
Speculums vaginaux, Velves vaginales  
Espéculos vaginales, Valvas vaginales  
Specoli vaginali, Valve vaginali

**GRAND**  
DEVICES  
The Grand Instruments Company



With taper blades, for virgins  
Mit konischen Blättern, für Jungfrauen  
A valves coniques, pour vierges  
Con hojas cónicas, para vírgenes  
Con valve coniche, per vergini

set no.  
satz Fig.  
jeu no.  
juego no.  
serie no.

consisting of  
bestehend aus  
se compositant de  
consiste de  
composto da

**KRISTELLER**

Fig. 1 **GD34.220.01** **GD34.221.01 + GD34.222.01**  
Fig. 2 **GD34.220.02** **GD34.221.02 + GD34.222.02**



**KRISTELLER**

105 x 18 mm **GD34.221.01**  
105 x 21 mm **GD34.221.02**

Speculum  
Spekulum  
Spéculum  
Espéculo  
Specolo



**KRISTELLER**

110 x 14 mm **GD34.222.01**  
115 x 17 mm **GD34.222.02**

Retractor  
Halter  
Valve  
Valva

Vaginal Specula, Vaginal Retractors  
 Vaginalspekula, Scheidenhalter  
 Speculums vaginaux, Velves vaginales  
 Espécules vaginales, Valvas vaginales  
 Specoli vaginali, Valve vaginali



set no.  
 satz Fig.  
 jeu no.  
 juego no.  
 serie no.

consisting of  
 bestehend aus  
 se compositant de  
 consiste de  
 composto da

**KRISTELLER**

Fig. 1	<b>GD34.230.01</b>	<b>GD34.231.00 + GD34.232.01</b>
Fig. 2	<b>GD34.230.02</b>	<b>GD34.231.01 + GD34.232.02</b>
Fig. 3	<b>GD34.230.03</b>	<b>GD34.231.02 + GD34.232.03</b>



**KRISTELLER**

Fig. 1	105 x 26 mm	<b>GD34.231.01</b>
Fig. 2	105 x 25 mm	<b>GD34.231.02</b>
Fig. 3	105 x 33 mm	<b>GD34.231.03</b>

Speculum  
 Spekulum  
 Spéculum  
 Espéculo  
 Specolo



**KRISTELLER**

Fig. 1	115 x 22 mm	<b>GD34.232.01</b>
Fig. 2	115 x 24 mm	<b>GD34.232.02</b>
Fig. 3	115 x 29 mm	<b>GD34.232.03</b>

Retractor  
 Halter  
 Valve  
 Valva



Vaginal Specula, Vaginal Retractors  
 Vaginalspekula, Scheidenhalter  
 Speculums vaginaux, Velves vaginales  
 Espécules vaginales, Valvas vaginales  
 Specoli vaginali, Valve vaginali



set no.  
 satz Fig.  
 jeu no.  
 juego no.  
 série no.

consisting of  
 bestehend aus  
 se compositant de  
 consiste de  
 composto da

**KRISTELLER**

Fig. 00	<b>GD34.239.99</b>	<b>GD34.239.99 + GD34.239.98</b>
Fig. 0	<b>GD34.240.00</b>	<b>GD34.241.00 + GD34.242.00</b>
Fig. 1	<b>GD34.240.01</b>	<b>GD34.241.01 + GD34.242.01</b>
Fig. 2	<b>GD34.240.02</b>	<b>GD34.241.02 + GD34.242.02</b>
Fig. 3	<b>GD34.240.03</b>	<b>GD34.241.03 + GD34.242.03</b>



**KRISTELLER**

Fig. 00	110 x 18 mm	<b>GD34.239.97</b>
Fig. 0	110 x 20 mm	<b>GD34.241.00</b>
Fig. 1	110 x 27 mm	<b>GD34.241.01</b>
Fig. 2	110 x 30 mm	<b>GD34.241.02</b>
Fig. 3	110 x 36 mm	<b>GD34.241.03</b>

Speculum  
 Spekulum  
 Spéculum  
 Espéculo  
 Specolo



**KRISTELLER**

Fig. 00	115 x 14 mm	<b>GD34.239.98</b>
Fig. 0	115 x 17 mm	<b>GD34.242.00</b>
Fig. 1	115 x 23 mm	<b>GD34.242.01</b>
Fig. 2	115 x 26 mm	<b>GD34.242.02</b>
Fig. 3	115 x 32 mm	<b>GD34.242.03</b>

Retractor  
 Halter  
 Valve  
 Valva

Vaginal Specula, Vaginal Retractors  
 Vaginalspekula, Scheidenhalter  
 Speculums vaginaux, Velves vaginales  
 Espécules vaginales, Valvas vaginales  
 Specoli vaginali, Valve vaginali



For children  
 Für Kinder  
 Pour enfants  
 Para niños  
 Per bambini

set no.  
 satz Fig.  
 jeu no.  
 juego no.  
 serie no.

consisting of  
 bestehend aus  
 se compositant de  
 consiste de  
 composto da

**KRISTELLER**

Fig. 0 **GD34.244.00** **GD34.245.00 + GD34.246.00**



**KRISTELLER**

70 x 15 mm **GD34.245.00**

Speculum  
 Spekulum  
 Spéculum  
 Espéculo  
 Specolo



**KRISTELLER**

70 x 10 mm **GD34.246.00**

Retractor  
 Halter  
 Valve  
 Valva



Vaginal Specula, Vaginal Retractors  
Vaginalspekula, Scheidenhalter  
Speculums vaginaux, Velves vaginales  
Espéculos vaginales, Valvas vaginales  
Specoli vaginali, Valve vaginali

**GRAND**<sup>®</sup>  
DEVICES  
The Grand Instruments Company



set no.  
satz Fig.  
jeu no.  
juego no.  
serie no.

consisting of  
bestehend aus  
se compositant de  
consiste de  
composto da

**KRISTELLER**

Fig. 0 **GD34.250.00** **GD34.251.01 + GD34.252.01**



**KRISTELLER**

135 x 36 mm **GD34.251.00**

Speculum  
Spekulum  
Spéculum  
Espéculo  
Specolo



**KRISTELLER**

140 x 30 mm **GD34.252.00**

Retractor  
Halter  
Valve  
Valva



Vaginal Specula, Vaginal Retractors  
 Vaginalspekula, Scheidenhalter  
 Speculums vaginaux, Velves vaginales  
 Espécules vaginales, Valvas vaginales  
 Specoli vaginali, Valve vaginali



set no.  
 satz Fig.  
 jeu no.  
 juego no.  
 serie no.

consisting of  
 bestehend aus  
 se compositant de  
 consiste de  
 composto da

**KALLMORGEN**

<b>GD34.260.01</b>	<b>1</b>	<b>GD34.261.01</b>	<b>GD34.262.01</b>
<b>GD34.260.02</b>	<b>2</b>	<b>GD34.261.02</b>	<b>GD34.262.02</b>



**KALLMORGEN**

70 x 40 mm **GD34.261.01**  
 90 x 40 mm **GD34.261.02**

Speculum  
 Spekulum  
 Spéculum  
 Espéculo  
 Specolo



**KALLMORGEN**

70 x 33 mm **GD34.262.01**  
 90 x 33 mm **GD34.262.02**

Retractor  
 Halter  
 Valve  
 Valva



Vaginal Specula  
Vaginalspekula  
Speculums vaginaux  
Espécules vaginales  
Specoli vaginali

**GRAND**  
DEVICES  
*The Grand Instruments Company*



**BRAUN**

56 x 13 mm **GD34.263.01**



**BRAUN**

60 x 10 mm **GD34.264.01**

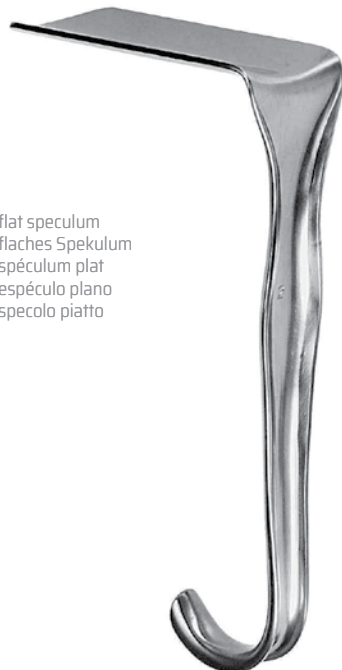

flat speculum  
flaches Spekulum  
spéculum plat  
espécule plano  
specolo piatto

**JACKSON**



**GD34.271.01**  
75 x 40 mm



**GD34.271.02**  
90 x 40 mm



**GD34.271.03**  
100 x 40 mm



Fig. 1 = small/klein/petit/pequeno/piccolo  
 Fig. 2 = medium/mittel/moyen/mediano/medio  
 Fig. 3 = large/groß/grand/grande

**SIMS**

Fig. 1	70 x 25 mm	<b>GD34.281.01</b>
Fig. 2	85 x 30 mm	<b>GD34.281.02</b>
Fig. 3	100 x 40 mm	<b>GD34.281.03</b>

Vaginal specula, double-ended  
 Scheidenspekula, doppelendig  
 Spéculums vaginaux, doubles  
 Espéculos vaginales, dobles  
 Specoli vaginali, doppi

**GD34.291.00**

bestehend aus  
 consisting of  
 consiste de  
 se composant de  
 composto da

**GD34.291.01 / GD34.291.02 /  
 GD34.291.03**



**SIMS**

Fig. 1	65 x 25 mm	70 x 30 mm	<b>GD34.291.01</b>
Fig. 2	70 x 30 mm	70 x 35 mm	<b>GD34.291.02</b>
Fig. 3	85 x 35 mm	90 x 40 mm	<b>GD34.291.03</b>



Vaginal Specula  
Vaginalspekula  
Speculums vaginaux  
Espéculos vaginales  
Specoli vaginali

**GRAND**  
DEVICES  
*The Grand Instruments Company*

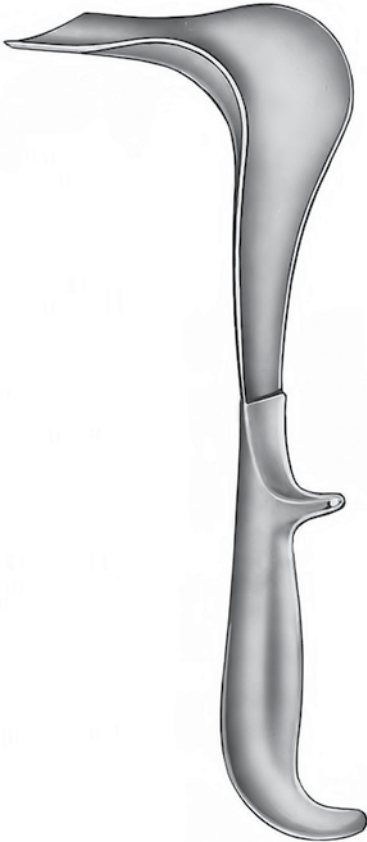

**DOYEN**

- Fig. 1 75 x 45 mm **GD34.300.01**
- Fig. 2 90 x 45 mm **GD34.300.02**
- Fig. 3 110 x 45 mm **GD34.300.03**



slightly concave  
leicht hohl  
légèrement concave  
ligeramente cóncavo  
leggermente concavo

**DOYEN**

- Fig. 1 55 x 35 mm **GD34.301.01**
- Fig. 2 85 x 35 mm **GD34.301.02**
- Fig. 3 115 x 35 mm **GD34.301.03**
- Fig. 1 55 x 45 mm **GD34.303.01**
- Fig. 2 85 x 45 mm **GD34.303.02**
- Fig. 3 115 x 45 mm **GD34.303.03**
- Fig. 4 160 x 45 mm **GD34.303.04**
- Fig. 1 55 x 60 mm **GD34.305.01**
- Fig. 2 85 x 60 mm **GD34.305.02**
- Fig. 3 115 x 60 mm **GD34.305.03**
- Fig. 4 160 x 60 mm **GD34.305.04**

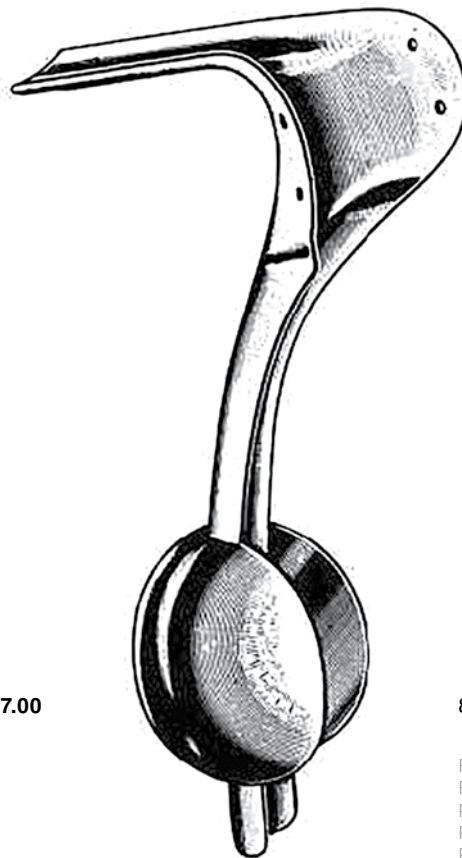

**AUVARD**

83 x 38 mm **GD34.307.00**

Detachable Weight  
Loses Gewicht  
Poids démontable  
Pessa desmontable  
Peso smontabile

**AUVARD**

83 x 38 mm **GD34.309.00**

Fixed Weight  
Festes Gewicht  
Poids fixe  
Pessa fija  
Peso fisso



Vaginal Specula  
Vaginalspekula  
Speculums vaginaux  
Espéculos vaginales  
Specoli vaginali

**GRAND**  
DEVICES  
*The Grand Instruments Company*



**BREISKY**

100 x 20 mm **GD34.310.20**  
100 x 25 mm **GD34.310.25**  
100 x 30 mm **GD34.310.30**  
100 x 35 mm **GD34.310.35**  
100 x 40 mm **GD34.310.40**  
130 x 20 mm **GD34.310.20**  
130 x 25 mm **GD34.310.25**  
130 x 30 mm **GD34.310.30**  
130 x 35 mm **GD34.310.35**  
130 x 40 mm **GD34.310.40**  
155 x 40 mm **GD34.310.40**



**DOYEN**

70 x 30 mm **GD34.317.24**  
25.0 cm



**SCHERBAK**  
**GD34.318.00**

complete Set with handle,  
 weight (400 g) and 5 blades  
 Satz komplett mit Griff,  
 Gewicht (400 g) und 5 Blättern  
 jeu complet avec manche,  
 poids (400 g) et 5 valves juego  
 completo con mango, peso  
 (400 g) y 5 valvas  
 Set completo con manico,  
 peso (400 g) e 5 valve

Specula Blade only  
 Blatt allein  
 Valve vaginale, seule  
 Valva vaginal, suelta  
 Valve vaginale, sola



**SCHERBAK**

80 x 30 mm **GD34.318.01**  
 85 x 35 mm **GD34.318.02**  
 90 x 40 mm **GD34.318.03**



**SCHERBAK**

62 x 40-60 mm **GD34.318.04**  
 81 x 45-70 mm **GD34.318.05**

Weight for Vaginal Speculum  
 Gewicht zum Vaginalspekulum  
 Poids pour spéculum vaginal  
 Peso para especulo vaginal  
 Peso per specolo vaginale

Handle for Vaginal Speculum  
 Griff zum Vaginalspekulum  
 Manche pour spéculum vaginal  
 Mango para especulo vaginal  
 Manico per specolo vaginale



**SCHERBAK**

10.5 cm 400 gm **GD34.318.10**  
 13.0 cm 800 gm **GD34.318.12**



**SCHERBAK**

20.0 cm **GD34.318.14**



Vaginal Specula  
Vaginalspekula  
Speculums vaginaux  
Espéculos vaginales  
Specoli vaginali

**GRAND**  
DEVICES  
*The Grand Instruments Company*



**LANDAU**

100 x 28 mm **GD34.319.28**  
100 x 38 mm **GD34.319.38**



**GD34.320.99**

**Strainer for Vaginal Speculum**

Auffangsieb  
Tarmis pour spéculum vaginal  
Tamiz para especulo vaginal  
Crivello per specolo vaginale

**WEISSBARTH**

80 x 42 mm **GD34.320.24**

complete, with detachable strainer  
komplett, mit abnehmbarem Auffangkorb  
complet avec tamis demontable  
completo, con tamiz desmontable  
completo con crivello smontabile





**FRIEDMANN**

10.0 cm **GD34.351.10**  
 15.0 cm **GD34.351.15**



**KOGAN**

24.5 cm **GD34.359.24**

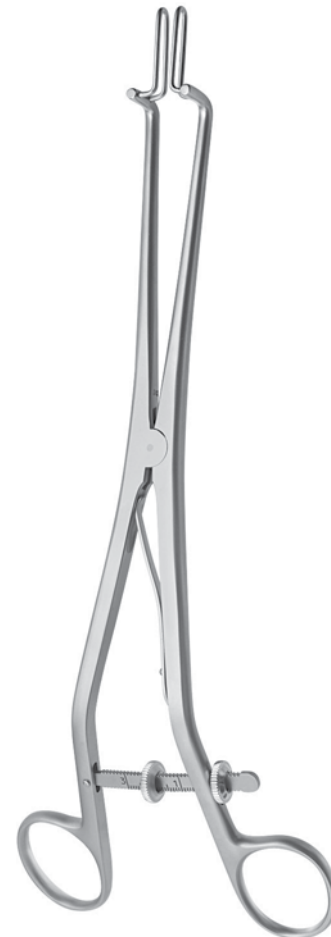

Standard **KOGAN** Laser  
**GD34.360.24** 24.0 cm **GD34.364.24**

with graduated ratchet and fixing screw  
 mit skalierter Sperre und Fixierschraube  
 avec crémaillère à échelle et vis à fixation  
 con cremallera graduada y tornillo de fijación  
 con cremagliera con scala e vite di fissaggio



**Uterine Dilators**  
**Uterusdilatoren**  
**Dilatateurs du col de l'utérus**  
**Dilataores uterinos Dilatatori**  
**uterini**

**GRAND**  
DEVICES  
*The Grand Instruments Company*

**HEGAR**  
**GD34.404.14**

Set of 14 pieces (full sizes) from  
4,0 - 17,0 mm without case

Satz mit 14 Stück (ganze Größen)  
von 4,0 - 17,0 mm ohne Etui

jeu de 14 pièces (taille entière)  
de 4,0 - 17,0 mm sans boîte

juego de 14 piezas (tamaños enteros)  
de 4,0 - 17,0 mm sin caja

serie di 14 pezzi (grandezza intera)  
da 4,0 - 17,0 mm senza scatola



**HEGAR**  
**GD34.404.26**

set of 26 pieces (full sizes)  
from 1,0 - 26,0 mm without case

Satz mit 26 Stück (ganze Größen)  
von 1,0 - 26,0 mm ohne Etui

jeu de 26 pièces (taille entière)  
de 1,0 - 26,0 mm sans boîte

juego de 26 piezas (tamaños enteros)  
de 1,0 - 26,0 mm sin caja

serie di 26 pezzi (grandezza intera)  
da 1,0 - 26,0 mm senza scatola

**HEGAR**

1 mm	<b>GD34.410.01</b>	1.5 mm	<b>GD34.415.01</b>
2 mm	<b>GD34.410.02</b>	2.5 mm	<b>GD34.415.02</b>
3 mm	<b>GD34.410.03</b>	3.5 mm	<b>GD34.415.03</b>
4 mm	<b>GD34.410.04</b>	4.5 mm	<b>GD34.415.04</b>
5 mm	<b>GD34.410.05</b>	5.5 mm	<b>GD34.415.05</b>
6 mm	<b>GD34.410.06</b>	6.5 mm	<b>GD34.415.06</b>
7 mm	<b>GD34.410.07</b>	7.5 mm	<b>GD34.415.07</b>
8 mm	<b>GD34.410.08</b>	8.5 mm	<b>GD34.415.08</b>
9 mm	<b>GD34.410.09</b>	9.5 mm	<b>GD34.415.09</b>
10 mm	<b>GD34.410.10</b>	10.5 mm	<b>GD34.415.10</b>
11 mm	<b>GD34.410.11</b>	11.5 mm	<b>GD34.415.11</b>
12 mm	<b>GD34.410.12</b>	12.5 mm	<b>GD34.415.12</b>
13 mm	<b>GD34.410.13</b>	13.5 mm	<b>GD34.415.13</b>
14 mm	<b>GD34.410.14</b>	14.5 mm	<b>GD34.415.14</b>
15 mm	<b>GD34.410.15</b>	15.5 mm	<b>GD34.415.15</b>
16 mm	<b>GD34.410.16</b>	16.5 mm	<b>GD34.415.16</b>
17 mm	<b>GD34.410.17</b>	17.5 mm	<b>GD34.415.17</b>
18 mm	<b>GD34.410.18</b>	18.5 mm	<b>GD34.415.18</b>
19 mm	<b>GD34.410.19</b>	19.5 mm	<b>GD34.415.19</b>
20 mm	<b>GD34.410.20</b>		
21 mm	<b>GD34.410.21</b>		
22 mm	<b>GD34.410.22</b>		
23 mm	<b>GD34.410.23</b>		
24 mm	<b>GD34.410.24</b>		
25 mm	<b>GD34.410.25</b>		
26 mm	<b>GD34.410.26</b>		
27 mm	<b>GD34.410.27</b>		
28 mm	<b>GD34.410.28</b>		
29 mm	<b>GD34.410.29</b>		
30 mm	<b>GD34.410.30</b>		



**HEGAR**

4-17 mm **GD34.405.14** 14 pcs./Stück/ea./c./u./pezzi



in metal case  
in Metalletui  
en boîte metal  
en caja metalica  
in scatola metallica

**HEGAR**

4-17 mm **GD34.406.14** 14 pcs./Stück/ea./c./u./pezzi  
1-26 mm **GD34.406.26** 26 pcs./Stück/ea./c./u./pezzi



Uterine Dilators  
Uterusdilatoren  
Dilatateurs du col de l'utérus  
Dilataores uternios  
Dilatatori uterini

**GRAND**  
DEVICES  
The Grand Instruments Company

HEGAR  
**GD34.424.08**

Set of 8 pieces from 3,0 / 4,0 - 17,0 / 18,0 mm  
without case

Satz mit 8 Stück von 3,0 / 4,0 - 17,0 / 18,0 mm  
ohne Etui

jeu de 8 pièces de 3,0 / 4,0 - 17,0 / 18,0 mm  
sans boîte

juego de 8 piezas de 3,0 / 4,0 - 17,0 / 18,0 mm  
sin caja

serie di 8 pezzi da 3,0 / 4,0 - 17,0 / 18,0 mm  
senza scatola



HEGAR  
**GD34.424.13**

Set of 13 pieces from 1,0 / 2,0 - 25,0 / 26,0 mm  
without case

Satz mit 13 Stück von 1,0 / 2,0 - 25,0 / 26,0 mm  
ohne Etui

jeu de 13 pièces de 1,0 / 2,0 - 25,0 / 26,0 mm  
sans boîte

juego de 13 piezas de 1,0 / 2,0 - 25,0 / 26,0 mm  
sin caja

serie di 13 pezzi da 1,0 / 2,0 - 25,0 / 26,0 mm  
senza scatola

HEGAR

1/2 mm	<b>GD34.420.01</b>
3/4 mm	<b>GD34.420.03</b>
5/6 mm	<b>GD34.420.05</b>
7/8 mm	<b>GD34.420.07</b>
9/10 mm	<b>GD34.420.09</b>
11/12 mm	<b>GD34.420.11</b>
13/14 mm	<b>GD34.420.13</b>
15/16 mm	<b>GD34.420.15</b>
17/18 mm	<b>GD34.420.17</b>
19/20 mm	<b>GD34.420.19</b>
21/22 mm	<b>GD34.420.21</b>
23/34 mm	<b>GD34.420.23</b>
25/26 mm	<b>GD34.420.25</b>

Uterine Dilators  
Uterusdilatoren  
Dilatateurs du col de l'utérus  
Dilataores uterinos Dilatori  
uterini



HEGAR  
**GD34.425.08**

Set of 8 pieces from 3,0 / 4,0 - 17,0 / 18,0 mm  
in boilable canvas roll

Satz mit 8 Stück von 3,0 / 4,0 - 17,0 / 18,0 mm  
in auskochbarer Stoffrolltasche

jeu de 8 pièces de 3,0 / 4,0 - 17,0 / 18,0 mm  
en pochette en treillis stérilisable par ébullition

juego de 8 piezas de 3,0 / 4,0 - 17,0 / 18,0 mm  
en bolsa de tela esterilizable por ebullicion

serie di 8 pezzi da 3,0 / 4,0 - 17,0 / 18,0 mm  
in busta di tela sterilizzabile

HEGAR  
**GD34.426.08**

Set of 8 pieces from 3,0 / 4,0 - 17,0 / 18,0 mm  
in metal case with hinged lid

Satz mit 8 Stück von 3,0 / 4,0 - 17,0 / 18,0 mm  
im Metalletui mit Scharnierdeckel

jeu de 8 pièces de 3,0 / 4,0 - 17,0 / 18,0 mm  
en boîte métal à charnière

juego de 8 piezas de 3,0 / 4,0 - 17,0 / 18,0 mm  
en caja metálica con tapa de bisagra

serie di 8 pezzi da 3,0 / 4,0 - 17,0 / 18,0 mm  
in scatola metallica con coperchio a cerniera



HEGAR  
**GD34.426.13**

Set of 13 pieces from 1,0 / 2,0 - 25,0 / 26,0 mm  
in metal case with hinged lid

Satz mit 13 Stück von 1,0 / 2,0 - 25,0 / 26,0 mm  
im Metalletui mit Scharnierdeckel

jeu de 13 pièces de 1,0 / 2,0 - 25,0 / 26,0 mm  
en boîte métal à charnière

juego de 13 piezas de 1,0 / 2,0 - 25,0 / 26,0 mm  
en caja metálica con tapa de bisagra

serie di 13 pezzi da 1,0 / 2,0 - 25,0 / 26,0 mm  
in scatola metallica con coperchio a cerniera



Uterine Dilators  
Uterusdilatoren  
Dilatateurs du col de l'utérus  
Dilataores uterrios  
Dilatatori uterini

**GRAND**  
DEVICES  
The Grand Instruments Company



American scala  
amerikanische Skala  
échelle américaine  
escala americana  
scala americana

	Fig. US.	HANK
3.5/4 mm	7/8	<b>GD34.430.08</b>
4.5/5 mm	9/10	<b>GD34.430.10</b>
5.5/6 mm	11/12	<b>GD34.430.12</b>
6.5/7 mm	13/14	<b>GD34.430.14</b>
7.5/8 mm	15/16	<b>GD34.430.16</b>
8.5/9 mm	17/18	<b>GD34.430.18</b>
9.5/10 mm	19/20	<b>GD34.430.20</b>
10.5/11 mm	21/22	<b>GD34.430.22</b>
11.5/12 mm	23/24	<b>GD34.430.24</b>
12.5/13 mm	25/26	<b>GD34.430.26</b>
13.5/14 mm	27/28	<b>GD34.430.28</b>

HANK  
**GD34.435.06**

set of 6 pieces  
from 4,5 - 10,0 mm without case

Satz mit 6 Stück  
von 4,5 - 10,0 mm ohne Etui

jeu de 6 pièces  
de 4,5 - 10,0 mm sans boîte

juego de 6 piezas  
de 4,5 - 10,0 mm sin caja

serie di 6 pezzi  
da 4,5 - 10,0 mm senza scatola

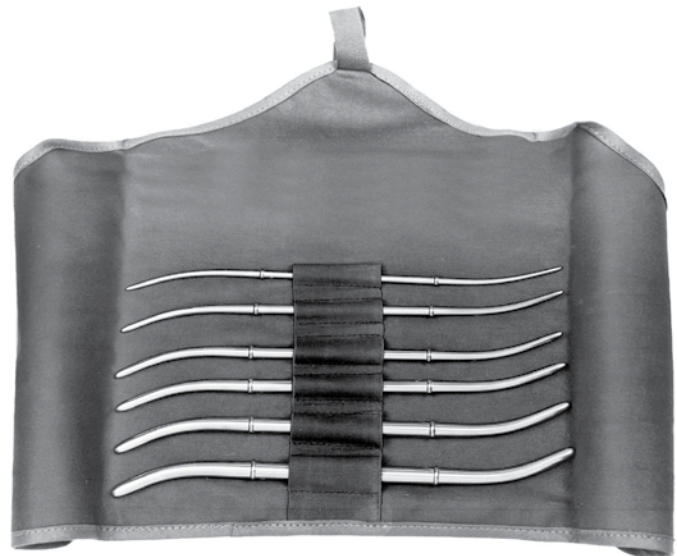

HANK  
**GD34.436.08**

set of 6 pieces from 4,5 - 10,0 mm  
in boilable canvas roll

Satz mit 6 Stück von 4,5 - 10,0 mm  
in auskochbarer Stoffrolltasche

jeu de 6 pièces de 4,5 - 10,0 mm  
en pochette en treillis stérilisable par ébullition

juego de 6 piezas de 4,5 - 10,0 mm  
en bolsa de tela esterilizable por ebullicion

serie di 6 pezzi da 4,5 - 10,0 mm  
in busta di tela sterilizzabile





**PRATT**  
**GD34.447.08**

set of 8 pieces from 4,5 / 5,0 - 13,6 / 14,3 mm  
 in boilable canvas roll

Satz mit 8 Stück von 4,5 / 5,0 - 13,6 / 14,3 mm  
 in auskochbarer Stoffrolltasche

jeu de 8 pièces de 4,5 / 5,0 - 13,6 / 14,3 mm  
 en pochette en treillis stérilisable par ébullition

juego de 8 piezas de 4,5 / 5,0 - 13,6 / 14,3 mm  
 en bolsa de tela esterilizable por ebullicion

serie di 8 pezzi da 4,5 / 5,0 - 13,6 / 14,3 mm  
 in busta di tela sterilizzabile

	Charr.	PRATT
4.5/5.0 mm	13/15	<b>GD34.447.13</b>
5.6/6.3 mm	17/19	<b>GD34.447.17</b>
7.0/7.6 mm	21/23	<b>GD34.447.21</b>
8.3/9.0 mm	25/27	<b>GD34.447.25</b>
9.6/10.3 mm	29/31	<b>GD34.447.29</b>
11.0/11.6 mm	33/35	<b>GD34.447.33</b>
12.3/13.0 mm	37/39	<b>GD34.447.37</b>
13.6/14.3 mm	41/43	<b>GD34.447.41</b>
14.9/15.6 mm	45/47	<b>GD34.447.45</b>
16.3/16.9 mm	49/51	<b>GD34.447.49</b>
17.6/18.3 mm	53/55	<b>GD34.447.53</b>
19.9/19.6 mm	57/59	<b>GD34.447.57</b>



Uterine Dilators  
Uterusdilatoren  
Dilateurs du col de l'utérus  
Dilatores uterinos  
Dilatatori uterini

**GRAND**  
DEVICES  
*The Grand Instruments Company*



**GOODELL**  
34.0 cm **GD34.441.34**



**WYLIE**  
29.0 cm **GD34.443.29**

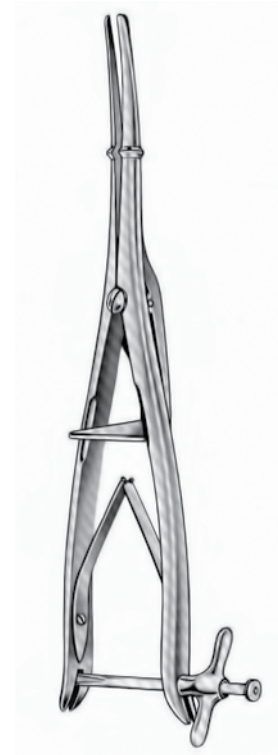

**SIMS**  
29.0 cm **GD34.445.29**



Tenaculum Forceps  
Hakenzangen  
Pinces pour abaissement du col de l'utérus  
Pinzas para coger el cuello del útero  
Pinze per abbassare il collo dell'utero



**SCHROEDER**

23.0 cm **GD34.502.23**  
25.0 cm **GD34.502.25**



**BRAUN**

25.0 cm **GD34.504.25**



**SKENE**

24.0 cm **GD34.505.24**



**POZZI**

25.0 cm **GD34.506.25**



**DUPLAY**

28.0 cm **GD34.507.28**



**STAUDE-MOORE**

17.0 cm **GD34.508.17**



Tenaculum Forceps  
Hakenzangen  
Pinces pour abaissement du col de l'uterus  
Pinzas para coger el cuello del útero  
Pinze per abbassare il collo dell'utero

**GRAND**  
DEVICES  
*The Grand Instruments Company*



**COLLIN-POZZI**  
25.0 cm **GD34.509.25**



**BARRETT**  
18.0 cm **GD34.510.18**

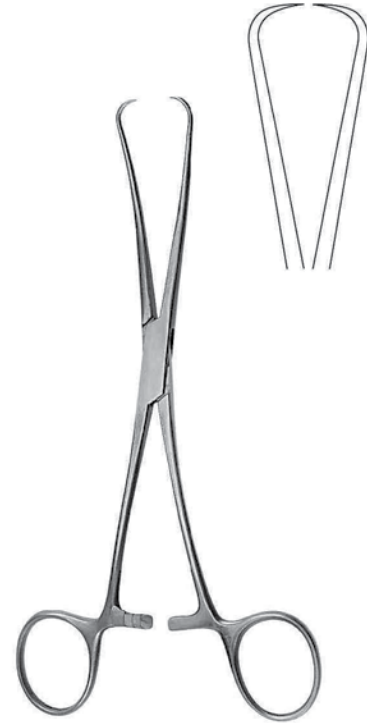

**JARCHO**  
20.0 cm **GD34.512.20**



2 x 2  
Teeth  
zähne  
dents  
dientes  
denti

**SCHROEDER**  
20.0 cm **GD34.514.20**  
24.0 cm **GD34.514.24**



2 x 2  
Teeth  
zähne  
dents  
dientes  
denti

**SCHROEDER**  
24.0 cm **GD34.515.24**



**SCHROEDER**  
22.0 cm **GD34.518.22**

Tenaculum Forceps  
 Hakenzangen  
 Pinces pour abaissement du col de l'uterus  
 Pinzas para coger el cuello del útero  
 Pinze per abbassare il collo dell'utero



2 x 2

Teeth  
 zähne  
 dents  
 dientes  
 denti



MUSEUX



MUSEUX  
 24.0 cm 6.0 mm **GD34.524.06**



MUSEUX  
 24.0 cm 8.0 mm **GD34.524.08**



MUSEUX  
 24.0 cm 10.0 mm **GD34.524.10**



MUSEUX



MUSEUX  
 24.0 cm 6.0 mm **GD34.525.06**



MUSEUX  
 24.0 cm 8.0 mm **GD34.525.08**



MUSEUX  
 24.0 cm 10.0 mm **GD34.525.10**

2 x 2

Teeth  
 zähne  
 dents  
 dientes  
 denti



MUSEUX  
 20.0 cm **GD34.526.20**

3 x 4

Teeth  
 zähne  
 dents  
 dientes  
 denti



TEALE  
 18.0 cm **GD34.531.18**  
 23.0 cm **GD34.531.23**  
 26.5 cm **GD34.531.26**



Tenaculum Forceps  
 Hakenzangen  
 Pincés pour abaissement du col de l'uterus  
 Pinzas para coger el cuello del útero  
 Pinze per abbassare il collo dell'utero



The Grand Instruments Company



2 x 2  
 Teeth  
 zähne  
 dents  
 dientes  
 denti

JAKOBS

21.0 cm GD34.532.21

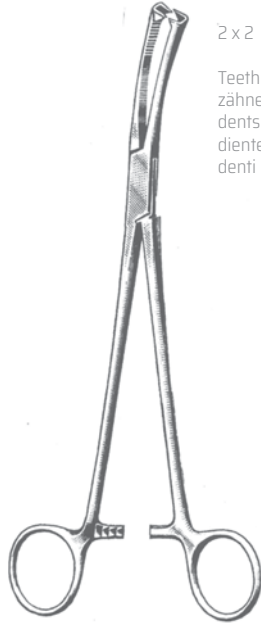

2 x 2  
 Teeth  
 zähne  
 dents  
 dientes  
 denti

JAKOBS

21.0 cm GD34.533.21



2 x 3  
 Teeth  
 zähne  
 dents  
 dientes  
 denti

HENROTIN

20.5 cm GD34.534.20



4 x 4  
 Teeth  
 zähne  
 dents  
 dientes  
 denti

PRATT

28.0 cm GD34.536.28

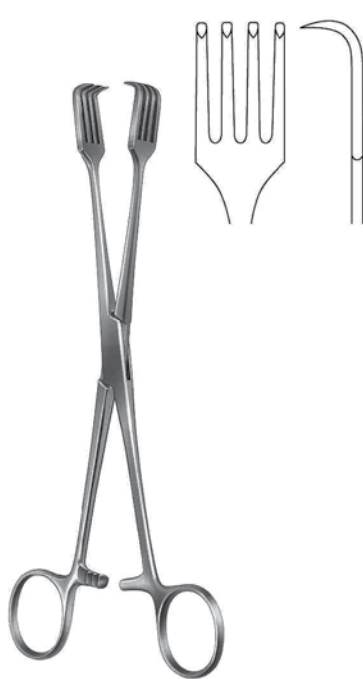

4 x 4  
 Teeth  
 zähne  
 dents  
 dientes  
 denti

CZERNY

21.0 cm GD34.537.21



4 x 4  
 Teeth  
 zähne  
 dents  
 dientes  
 denti

BRAUN

15.5 cm GD34.538.15

Tenaculum Forceps  
Hakenzangen  
Pinces pour abaissement du col de l'uterus  
Pinzas para coger el cuello del útero  
Pinze per abbassare il collo dell'utero



4 x 4  
Teeth  
zähne  
dents  
dientes  
denti

**PRATT**  
26.0 cm **GD34.538.26**

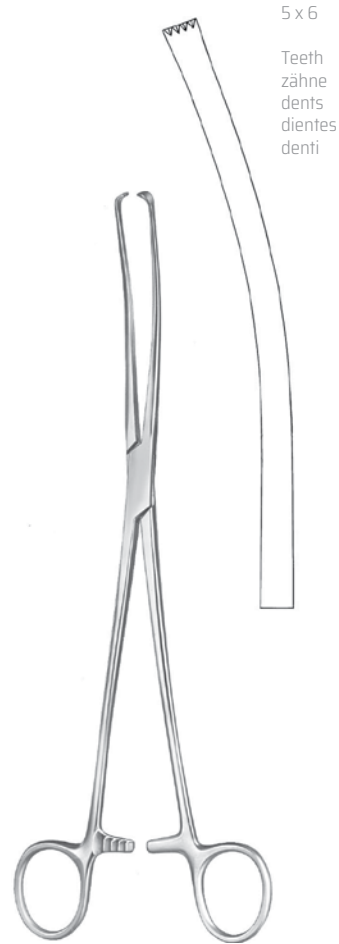

5 x 6  
Teeth  
zähne  
dents  
dientes  
denti

**IOWA**  
26.0 cm **GD34.539.26**



Uterine Polypus Forceps  
Uterus-Polypenzangen  
Pinces à polypes uterins  
Pinzas per polipi uterine

**GRAND**  
DEVICES  
*The Grand Instruments Company*

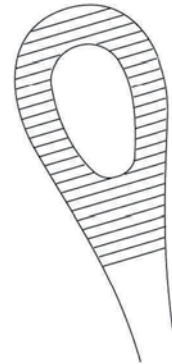

**NOTO**

27.0 cm **GD34.540.27**



**DOYEN**

20.0 cm **GD34.542.20**



**KELLY**

32.0 cm **GD34.543.32**

Uterine Elevating Forceps  
Uterus-Faßzangen  
Pinces hystérolabes  
Pinzas para el útero  
Pinzas per afferrare l'utero



**DARTIGUES**

27.0 cm **GD34.545.27**



**SOMER**

23.0 cm **GD34.547.23**



**COLLIN**

25.0 cm **GD34.549.25**



**COLLIN**

28.0 cm **GD34.550.28**



Uterine Elevating Forceps  
Uterus-Faßzangen  
Pinces hystérolabes  
Pinzas para el útero  
Pinzas per afferrare l'utero

**GRAND**  
DEVICES  
*The Grand Instruments Company*

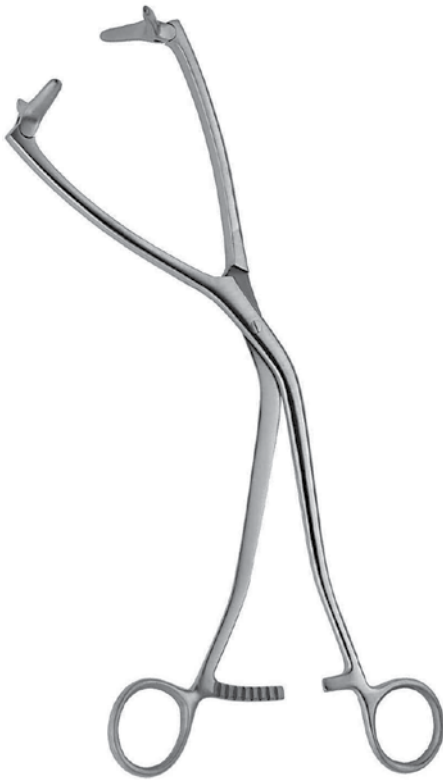

**COLLIN**  
25.0 cm **GD34.551.25**



**BUMM**  
28.0 cm **GD34.552.28**



**SIEGLER HELLMANN**  
24.0 cm **GD34.553.24**



Uterine Sounds, Uterine Depressor  
 Uterussonden, Uterusdepressor  
 Hystéromètres, Dépresseur utérin  
 Histerómetros, Depresor uterino  
 Isterometri, Depressore uterino



Amniotome  
 Amniotom  
 Amniotome  
 Amniótomo  
 Amniotomo

**BEACHMANN**

26.0 cm **GD34.559.26**



**BRAUN**

28.0 cm **GD34.565.28**



Uterine Depressors  
 Uterus-Depressoren  
 Dépresseurs utérins  
 Depressores uterinos  
 Depressori uterini

**SIMS**

26.0 cm **GD34.567.26**



starr  
 rigid  
 rigide  
 rigida  
 rigida

**SIMS**

**GD34.580.32** 32.0 cm

Uterine Sounds  
 Uterus-Sonden  
 Hystéromètres  
 Histerómetros  
 Isterometri

malleable  
 biegsam  
 malléable  
 malleabile  
 malleabile

**GD34.581.32**



starr  
 rigid  
 rigide  
 rigida  
 rigida

**MARTIN**

**GD34.582.32** 32.0 cm **GD34.583.32**

malleable  
 biegsam  
 malléable  
 malleabile  
 malleabile



**COLLIN**

28.0 cm **GD34.584.28**



**VALLEIX**

29.5 cm **GD34.585.29**



Uterine Biopsy Aspirating Curettes  
Uterus-Biopsie-Saugküretten  
Curettes aspirantes à biopsie de l'utérus  
Curetas aspiradoras p. la biopsia uterina  
Curette di aspirazione per biopsia

**GRAND**  
DEVICES  
*The Grand Instruments Company*



**RANDALL**

24.0 cm 4 mm **GD34.590.04**

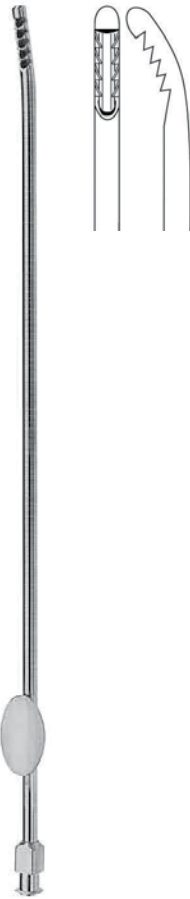

**NOVAK**

1 mm **GD34.592.01**  
2 mm **GD34.592.02**  
3 mm **GD34.592.03**  
4 mm **GD34.592.04**

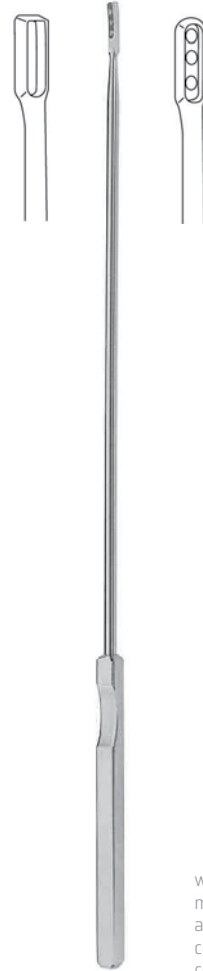

**KEVORKIAN**

**GD34.594.12** 30.0 cm 1.2 mm  
**GD34.594.40** 30.0 cm 4.0 mm **GD34.596.40**

with basket  
mit Korb  
avec grille  
con cesto  
con cestino

Biopsy Specimen Forceps  
Probeexcisionszangen  
Pincas amporte-pièce pour le col de l'utérus  
Pinzas sacabocado para el cuello del útero  
Pinze taglienti per biopsia



**FAURE**  
21.0 cm **GD34.601.21**



**SCHUBERT**  
21.0 cm **GD34.604.21**  
28.0 cm **GD34.604.28**



**SCHUBERT**  
26.0 cm **GD34.605.26**



Biopsy Specimen Forceps  
Biopsiezangen  
Pincès à biopsie  
Pinzas sacabocado p. biopsia  
Pinze per biopsia

**GRAND**  
DEVICES  
The Grand Instruments Company

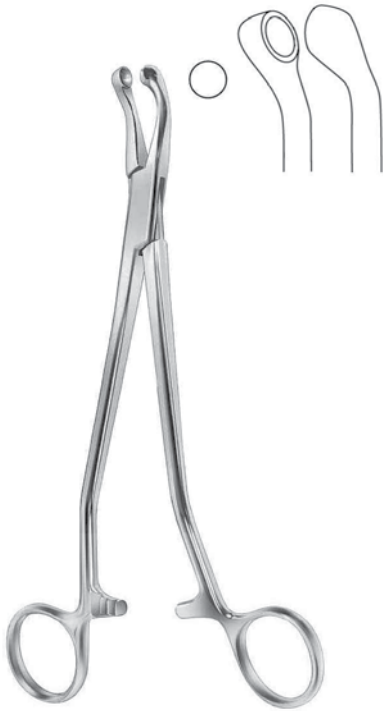

**THOMS-GAYLOR**  
23.5 cm **GD34.606.21**  
21.0 cm **GD34.606.24**



**GELLHORN**  
23.0 cm **GD34.609.23**

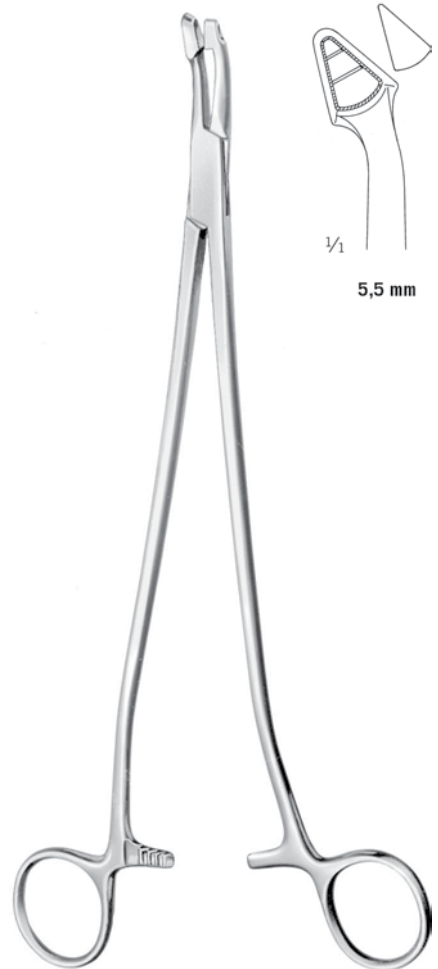

**van DOREN**  
25.0 cm **GD34.611.25**

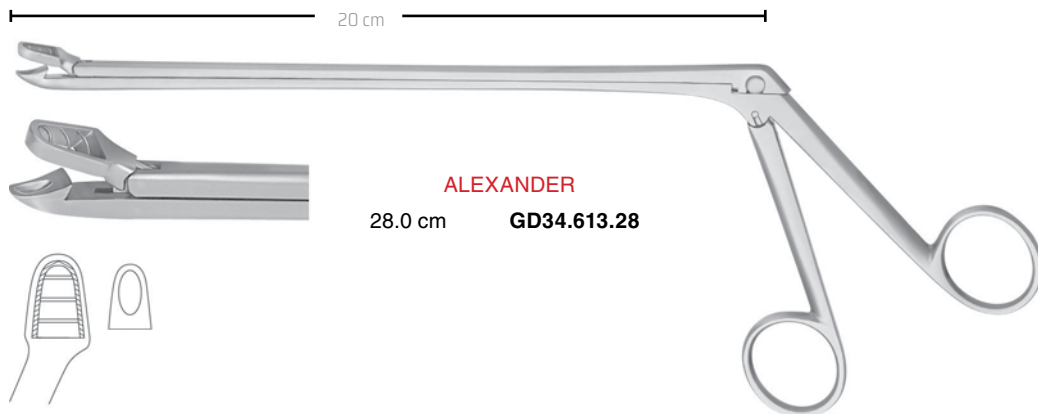

**ALEXANDER**  
28.0 cm **GD34.613.28**

Biopsy Specimen Forceps  
 Biopsiezangen  
 Pinces à biopsie  
 Pinzas sacabocado p. biopsia  
 Pinze per biopsia

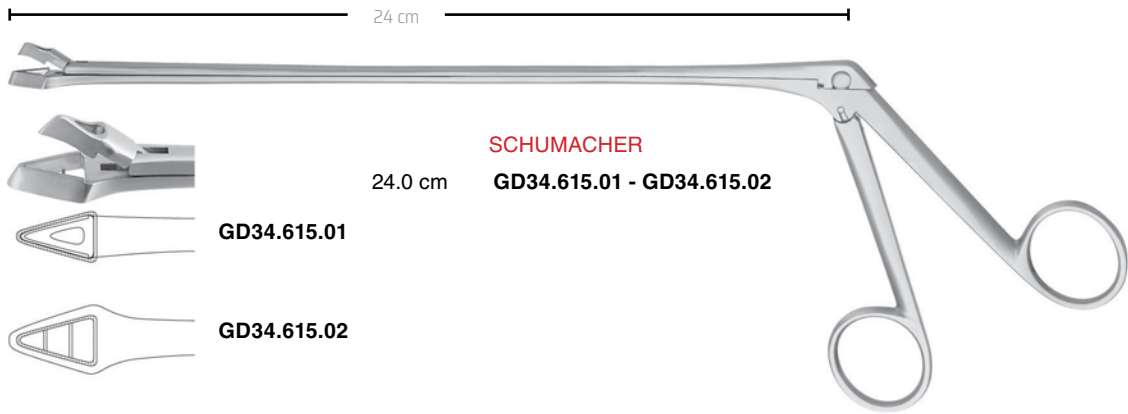

**SCHUMACHER**

24.0 cm **GD34.615.01 - GD34.615.02**

**GD34.615.01**

**GD34.615.02**



**KEVORKIAN (YOUNGE)**

24.5 cm **GD34.617.04**



**WINTER**

**GD34.618.23** 23.0 cm **GD34.619.23**

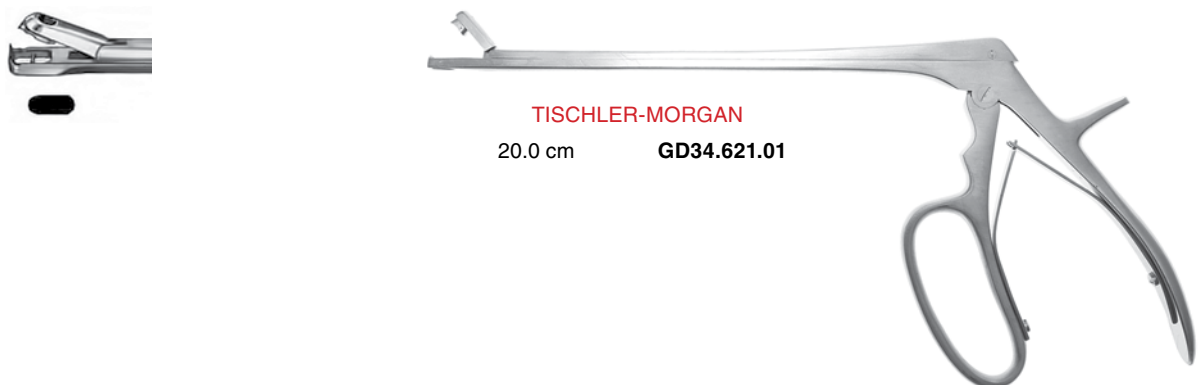

**TISCHLER-MORGAN**

20.0 cm **GD34.621.01**



Biopsy Specimen Forceps  
 Biopsiezangen  
 Pincès à biopsie  
 Pinzas sacabocado p. biopsia  
 Pinze per biopsia



Oval 7 x 5 mm



**BURKE**  
**GD34.622.00**

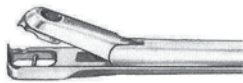

Fig. 1

**TISCHLER Morgan**



compl. instr.  
 Instr. kompl.  
 Instrum. compl.  
 Strumento completo

Tip only  
 Aufsatz allein  
 Embout seul  
 Punta sola

**TOWNSEND**

- |        |                    |                    |
|--------|--------------------|--------------------|
| Fig. 1 | <b>GD34.624.01</b> | <b>GD34.624.11</b> |
| Fig. 3 | <b>GD34.624.03</b> | <b>GD34.624.13</b> |
| Fig. 4 | <b>GD34.624.04</b> | <b>GD34.624.14</b> |
| Fig. 5 | <b>GD34.624.05</b> | <b>GD34.624.15</b> |

**GD34.624.99**  
 handle only  
 Griff allein  
 manche seul  
 manico solo  
 mango suelto

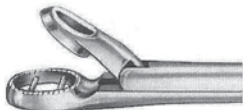

Fig. 3

● Oval 3.7 x 5 mm



Fig. 5

Mini

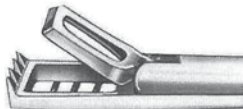
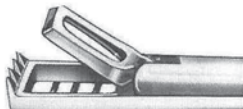

Fig. 4

**KEVORKAN**



■ 3 x 8 mm



**KEVORKIAN-Pacific**  
**GD34.625.04**

Biopsy Specimen Forceps  
Biopsiezangen  
Pinces à biopsie  
Pinzas sacabocado p. biopsia  
Pinze per biopsia



2.3 x 4.2 mm



TOWNSEND-MINI (BABY TISCHLER)

GD34.626.00



3.0 x 9.5 mm



TISCHLER-KEVORKIAN

GD34.627.00



4.0 x 6.5 mm



BAGGISH

GD34.628.00



4.5 x 8.0 mm



EPPENDORFER

GD34.630.00



**Biopsy Specimen Forceps**  
**Biopsiezangen**  
**Pinces à biopsie**  
**Pinzas sacabocado p. biopsia**  
**Pinze per biopsia**

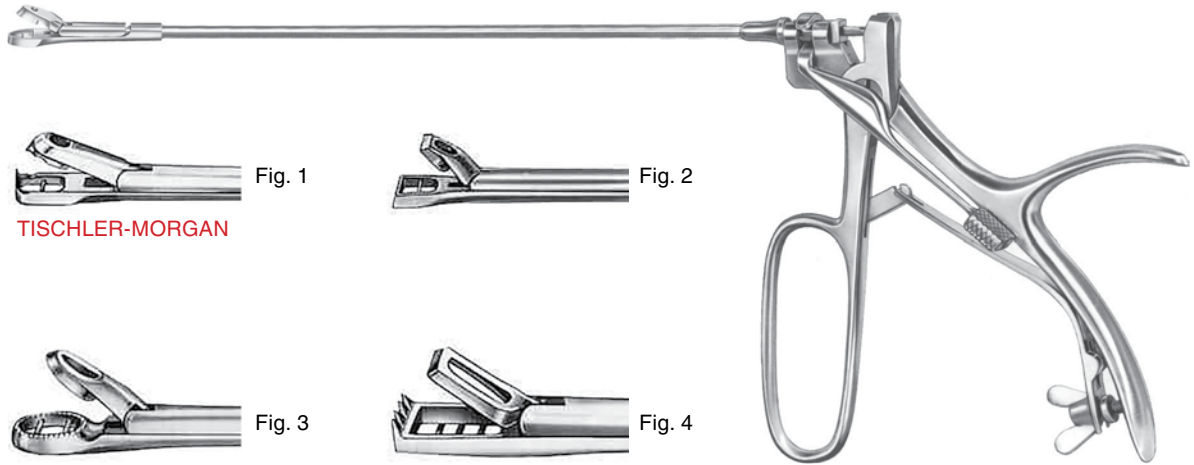

**TISCHLER-MORGAN**

**KEVORKIAN**

compl. instr.  
 Instr. kompl.  
 Instrum. compl.  
 Strumento completo

Tip only  
 Aufsatz allein  
 Embout seul  
 Punta sola

- Fig. 1 **GD34.632.01** **GD34.632.11**
- Fig. 2 **GD34.632.02** **GD34.632.12**
- Fig. 3 **GD34.632.03** **GD34.632.13**
- Fig. 4 **GD34.632.04** **GD34.632.14**

Myoma Screw  
 Myom-Heber  
 Tracteur pour fibromes  
 Tirabuzón para fibromas  
 Tiramiomi



**DOYEN**

15.0 cm **GD34.641.17**

Myoma knives  
 Myommesser  
 Evidens pour fibromes  
 Cuchillo para fibromas  
 Bisturi per fibromi



**SEGOND**

27.0 cm **GD34.643.27**



**EMMET**

22.0 cm

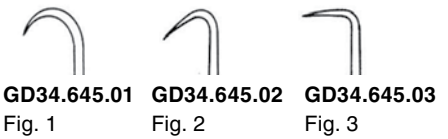

**GD34.645.01**  
 Fig. 1

**GD34.645.02**  
 Fig. 2

**GD34.645.03**  
 Fig. 3



**GD34.645.04**  
 Fig. 4

**GD34.645.05**  
 Fig. 5

Fistula Hooks  
 Fistelhaken  
 Crochets pour fistules  
 Ganchos para fistulas  
 Unicini per fistole





**SCHULTZE**  
Compl. **GD34.650.00**

in wooden case  
im Holzetui  
en boîte de bois  
en estuche de madera  
in scatola di legno



**SCHULTZE**  
**GD34.650.01**

without manometer  
ohne Manometer  
sans manomètre  
sin manómetro  
senza manometro



**SCHULTZE**  
**GD34.650.10**

Manometer for Salpingograph  
Manometer zum Salpingograph  
Manomètre pour salpingographe  
Manómetro para salpingógrafo  
Manometro per salpingografo



Uterine Curettes  
 Uteruslöffel, -kürette  
 Curettas utérinas  
 Curetas uterinas  
 Curetta uterine

**GRAND**  
 DEVICES  
 The Grand Instruments Company

sharp  
 scharf  
 tranchant  
 cortante  
 tagliente



**SIMON**

- Fig. 1 **GD34.702.01**
- Fig. 2 **GD34.702.02**
- Fig. 3 **GD34.702.03**
- Fig. 4 **GD34.702.04**
- Fig. 5 **GD34.702.05**
- Fig. 6 **GD34.702.06**  
25.0 cm



**SCHROEDER**

- Fig. 1 **GD34.703.01**
- Fig. 2 **GD34.703.02**
- Fig. 3 **GD34.703.03**
- Fig. 4 **GD34.703.04**
- Fig. 5 **GD34.703.05**
- Fig. 6 **GD34.703.06**  
31.0 cm



sharp/blunt  
 scharf/stumpf  
 tranchant/mousse  
 cortante/roma  
 tagliente/smussa

**BLAKE**

- 27.0 cm **GD34.704.27**



**GOURDET**

- Fig. 1 **GD34.706.01**
- Fig. 2 **GD34.706.02**
- Fig. 3 **GD34.706.03**
- Fig. 4 **GD34.706.04**
- Fig. 5 **GD34.706.05**  
28.0 cm

Uterine Curettes  
 Uterus-Küretten  
 Curettes utérines  
 Curetas uterinas  
 Curette uterine

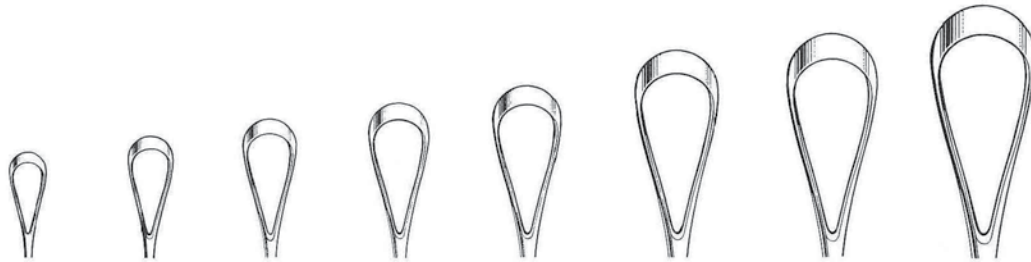

SIMS = 31.0 cm  
 RECAIMER = 31.0 cm

Fig.	00	0	1	2	3	4	5	6
mm	5	6	7	8	9	11	12	14



SIMS = 31.0 cm  
 RECAIMER = 31.0 cm

Fig.	7	8	9	10
mm	15	16	19	20

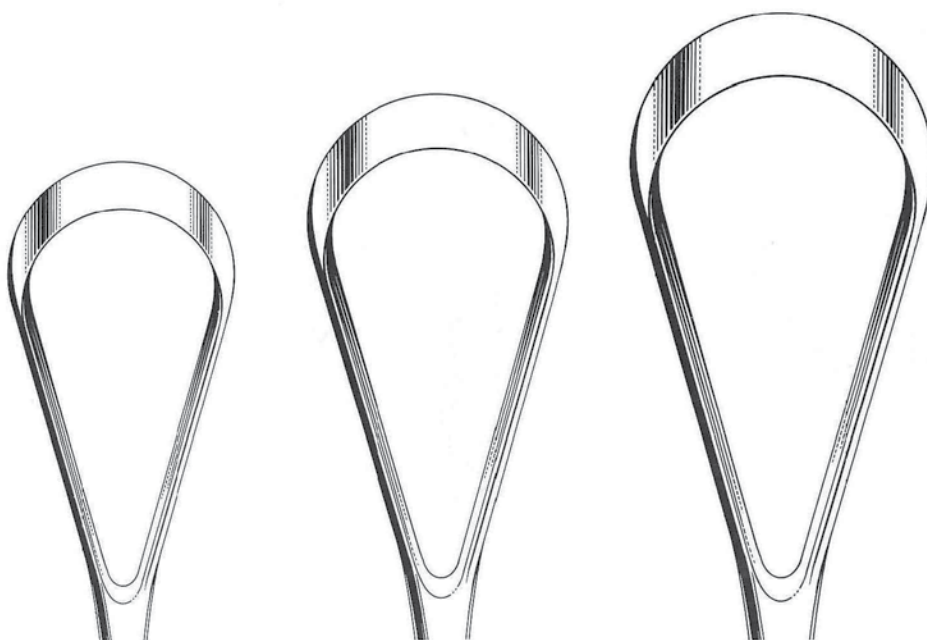

SIMS  
 RECAIMER  
 RECAIMER = 34.0 cm  
 GD34.710.05 - GD34.737.40

Fig.	14	15	16
mm	30	35	40



Uterine Curettes  
 Uterus-Küretten  
 Curettes utérines  
 Curetas uterinas  
 Curette uterine

**GRAND**  
 DEVICES  
 The Grand Instruments Company



**SIMS**

31.0 cm **GD34.710.05 - GD34.717.14**



**RECAMIER**

31.0 cm **GD34.720.07 - GD34.727.25**



**BUMM**

34.0 cm **GD34.730.30 - GD34.737.40**

Features	sharp	blunt
Ausführung	scharf	stumpf
Exécution	tranch.	mousse
Ejecución	cort.	roma
Esecuzione	tagl.	smussa
flex/fest	A	B
rig/fless.	C	D

Fig.	A	B	C	D	A	B	C	D	A	B	C	D
00	GD34.710.05	GD34.712.05	GD34.715.05	GD34.717.05	GD34.720.05	GD34.722.05	GD34.725.05	GD34.727.05				
0	GD34.710.06	GD34.712.06	GD34.715.06	GD34.717.06	GD34.720.06	GD34.722.06	GD34.725.06	GD34.727.06				
1	GD34.710.07	GD34.712.07	GD34.715.07	GD34.717.07	GD34.720.07	GD34.722.07	GD34.725.07	GD34.727.07				
2	GD34.710.08	GD34.712.08	GD34.715.08	GD34.717.08	GD34.720.08	GD34.722.08	GD34.725.08	GD34.727.08				
3	GD34.710.09	GD34.712.09	GD34.715.09	GD34.717.09	GD34.720.09	GD34.722.09	GD34.725.09	GD34.727.09				
4	GD34.710.11	GD34.712.11	GD34.715.11	GD34.717.11	GD34.720.11	GD34.722.11	GD34.725.11	GD34.727.11				
5	GD34.710.12	GD34.712.12	GD34.715.12	GD34.717.12	GD34.720.12	GD34.722.12	GD34.725.12	GD34.727.12				
6	GD34.710.14	GD34.712.14	GD34.715.14	GD34.717.14	GD34.720.14	GD34.722.14	GD34.725.14	GD34.727.14				
7					GD34.720.15	GD34.722.15	GD34.725.15	GD34.727.15				
8					GD34.720.16	GD34.722.16	GD34.725.16	GD34.727.16				
9					GD34.720.19	GD34.722.19	GD34.725.19	GD34.727.19				
10					GD34.720.20	GD34.722.20	GD34.725.20	GD34.727.20				GD34.737.28
14									GD34.730.30	GD34.732.30	GD34.735.30	GD34.737.30
15									GD34.730.35	GD34.732.35	GD34.735.35	GD34.737.35
16									GD34.730.40	GD34.732.40	GD34.735.40	GD34.737.40



**GD34.810.50**

Coupling Piece  
 Kupplungsstück  
 Pièce de raccordement  
 Pieza de acoplamiento  
 Pezzo di collegamento



Tubal seizing forceps  
 Tubenfaßpinzette  
 Pince a saisir les trompes  
 Pinza para sostener trompas  
 Pinze per afferare trompe

- Ø 3.0 mm **GD34.810.03**
- Ø 4.0 mm **GD34.810.04**
- Ø 6.0 mm **GD34.810.06**
- Ø 8.0 mm **GD34.810.08**
- Ø 10.0 mm **GD34.810.10**
- Ø 12.0 mm **GD34.810.12**
- Ø 14.0 mm **GD34.810.14**
- 29.0 cm

**NEUBÜSSER**

- Ø 6.0 mm **GD34.850.06**
- Ø 8.0 mm **GD34.850.08**
- Ø 10.0 mm **GD34.850.10**
- 20.0 cm



( ELECTRO SURGICAL)  
High Frequency Surgery  
Hochfrequenz-Chirurgie  
Chirurgie à haute fréquence  
Electrocirugía  
Elettrochirurgia  
高频手术



**GD35**



High Frequency Surgery  
 Hochfrequenz-Chirurgie  
 Chirurgie à haute fréquence  
 Electrocirugía  
 Electrochirurgia

**GRAND**  
 DEVICES  
 The Grand Instruments Company



**GD35.100.01**  
 Fig. 1



**GD35.100.02**  
 Fig. 2  
 45°



**GD35.100.03**  
 Fig. 3  
 120°



**GD35.100.11**  
 Fig. 11  
 Ø 3 mm



**GD35.100.12**  
 Fig. 11  
 Ø 5 mm



**GD35.100.13**  
 Fig. 13  
 Ø 8 mm



**GD35.100.14**  
 Fig. 14



**GD35.100.15**  
 Fig. 16  
 7.0 x 1.5 mm  
 45°



**GD35.100.16**  
 Fig. 16  
 7.0 mm  
 45°



**GD35.100.17**  
 Fig. 18  
 6.0 x 1.3 mm



**GD35.100.18**  
 Fig. 18  
 7.0 x 1.7 mm  
 30°



**GD35.100.21**  
 Fig. 21  
 7.0 x 1.7 mm



**GD35.100.31**  
 Fig. 31  
 Ø 0,6 mm  
 45°



**GD35.100.33**  
 Fig. 33  
 Ø 1.7 mm  
 45°



**GD35.100.34**  
 Fig. 34  
 Ø 3.0 mm  
 45°



**GD35.100.35**  
 Fig. 35



**GD35.100.36**  
 Fig. 36  
 90°

Schaft • shaft • tige  
 vástago • asta  
 Ø 1,6 mm





Cutting and Coagulation Electrodes  
 Elektroden zum Schneiden und Koagulieren  
 Electrodes pour la coupe et la coagulation  
 Electrodo para cortar y para la coagulación  
 Elettrodi di taglio e di coagulazione

Series MICRO + DENTAL



**GD35.101.51**  
 Fig. 51  
 Ø 5 mm  
 45°



**GD35.101.52**  
 Fig. 52  
 7.0 x 1.7 mm  
 45°



**GD35.101.53**  
 Fig. 53  
 45°



**GD35.101.54**  
 Fig. 54



**GD35.101.55**  
 Fig. 55



**GD35.101.56**  
 Fig. 56  
 Ø 5 mm  
 45°



**GD35.101.61**  
 Fig. 52  
 7.0 x 1.7 mm  
 45°



**GD35.101.62**  
 Fig. 62  
 7.0 x 1.7 mm  
 90°

Schaft • shaft • tige  
 vástago • asta  
 Ø 4 mm



**GD35.200.01**



**GD35.200.02**



**GD35.200.03**



**GD35.200.04** Ø mm  
 5  
 10  
 20



Ø mm  
 5  
 10  
 20



Ø mm  
 2  
 4  
 6



**GD35.300.02**  
**GD35.300.03**  
**GD35.300.04**

Schaft • shaft • tige  
 vástago • asta  
 Ø 4 mm



**Bipolar Coagulation**  
**Bipolare Koagulation**  
**Coagulation bipolaire**  
**Coagulación bipolar**  
**Coagulazione bipolare**

**GRAND**  
DEVICES  
*The Grand Instruments Company*

Hand Surgery, Ophthalmology, Plastic Surgery, Experimental Surgery  
Handchirurgie, Ophthalmologie, Plastische Chirurgie, Experimentelle Chirurgie  
Chirurgie de la main, Ophtalmologie, Chirurgie plastique, Chirurgie expérimentale  
Cirugía de la mano, Oftalmología, Cirugía plástica, Cirugía experimental  
Chirurgia della mano, Oftalmologia, Chirurgia plastica, Chirurgia sperimentale



**GD35.012.11**  
11.0 cm



**GD35.014.11**  
11.0 cm



**GD35.015.11**  
11.0 cm



**GD35.019.11**  
11.0 cm



**GD35.013.11**  
11.0 cm



**GD35.015.11**  
11.0 cm

Mikrochirurgie, HNO • Microsurgery, ENT • Microchirurgie, ORL • Microcirurgia, ORL • Microchirurgia, ORL



**GD35.212.16**  
16.5 cm



**GD35.213.16**  
16.5 cm



**GD35.214.16**  
16.5 cm



**GD35.215.16**  
16.5 cm



**GD35.217.16**  
16.5 cm

Bipolar Coagulation  
 Bipolare Koagulation  
 Coagulation bipolaire  
 Coagulación bipolar  
 Coagulazione bipolare



Mikrochirurgie, HNO • Microsurgery, ENT • Microchirurgie, ORL • Microcirugía, ORL • Microchirurgia, ORL



**GD35.315.16**  
 16.5 cm



**GD35.319.16**  
 16.5 cm



**GD35.412.16**  
 16.5 cm



**GD35.414.16**  
 16.5 cm



**GD35.416.16**  
 16.5 cm  
 1 mm

Gynäkologie, HNO, Tonsillenchirurgie • Gynaecology, ENT, Tonsil Surgery • Gynécologie, ORL, Chirurgie des amygdales  
 Ginecología, ORL, Cirugía de amígdalas • Ginecologia, ORL, Chirurgia tonsillare



**GD35.512.19**  
 19.5 cm



**GD35.514.19**  
 19.5 cm  
 1 mm



**GD35.517.19**  
 19.5 cm  
 1 mm



**GD35.519.19**  
 19.5 cm  
 2 mm



Bipolar Coagulation  
Bipolare Koagulation  
Coagulation bipolaire  
Coagulación bipolar  
Coagulazione bipolare

**GRAND**  
DEVICES  
*The Grand Instruments Company*



**GD35.612.19**  
19.5 cm



**GD35.614.19**  
19.5 cm  
1 mm



**GD35.616.19**  
19.5 cm  
2 mm



**GD35.617.19**  
19.5 cm  
1 mm



**GD35.619.19**  
19.5 cm  
1 mm



**GD35.712.03**  
0.3 mm



**GD35.712.07**  
0.7 mm



**GD35.712.12**  
1.2 mm

**GD35.712.03 - GD35.712.12**

22.5 cm  
0.3 - 1.2 mm

Bipolar Coagulation  
 Bipolare Koagulation  
 Coagulation bipolaire  
 Coagulación bipolar  
 Coagulazione bipolare



Connection Cords  
 Anschlußkabel  
 Cordons d'alimentation  
 Cables de conexión  
 Cavi da connessione

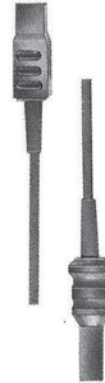

m  
 3  
 5

**GD35.910.30**  
**GD35.910.50**  
 ERBE  
 SELECT

**GD35.911.30**  
 AESCULAP

**GD35.912.30**  
**GD35.912.50**  
 USA Mod.

**GD35.913.30**  
**GD35.913.50**  
 MARTIN

Electrosurgery Equipment  
 HF-Chirurgie-Geräte  
 Electrobistouris  
 Electrobisturías  
 Elettrobisturi



Bipolar Scissors  
 Bipolaire schaar  
 Ciseaux bipolaires  
 Tijeras bipolares  
 Forbici bipolarari

**GRAND**  
 DEVICES  
*The Grand Instruments Company*



REUSABLE

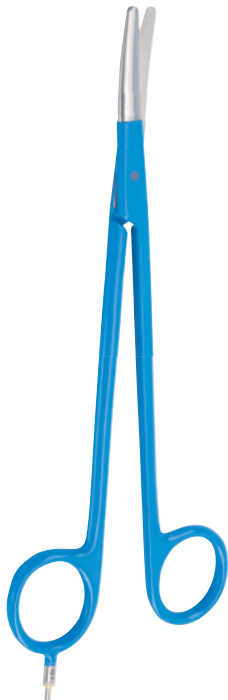





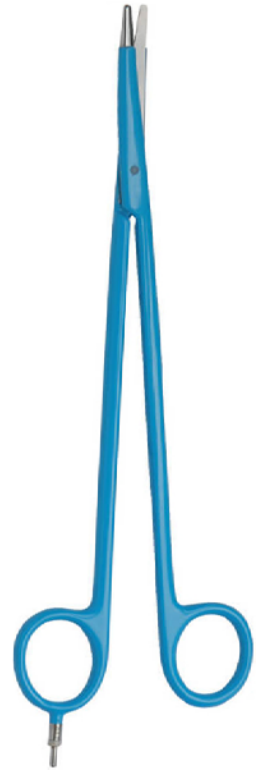

METZENBAUM



Length	curved Standard	curved slim	reusable
18 cm	<b>GD35.1381.18</b>	<b>GD35.1382.18</b>	<b>GD35.1383.18</b>
21 cm	<b>GD35.1381.21</b>	<b>GD35.1382.21</b>	<b>GD35.1383.21</b>
23 cm	<b>GD35.381.23</b>	<b>GD35.1382.23</b>	<b>GD35.1383.23</b>
28 cm	<b>GD35.1381.28</b>	<b>GD35.1382.28</b>	<b>GD35.1383.28</b>

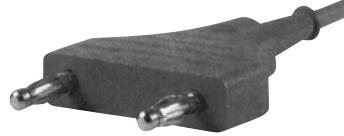

*Bipolar connecting cables for illustrated scissors*

Plug, generator side	Plug, instrument side	Length	
 Erbe ACC / ICC, Storz		3 m	<b>GD35.300.202</b>
		5 m	<b>GD35.300.203</b>
 Martin, Berchtold, Aesculap		3 m	<b>GD35.300.204</b>
		5 m	<b>GD35.300.205</b>
 Valleylab, Lamidey, EMC		3 m	<b>GD35.300.206</b>
		5 m	<b>GD35.300.207</b>

Bipolar Scissors  
Bipolaire schaar  
Ciseaux bipolaires  
Tijeras bipolares  
Forbici bipolarari



**GD35.1390.18** 18 cm **GD35.1391.18** **GD35.1393.23** 23 cm **GD35.1392.23**



Bipolar Forceps  
 Bipolare Pinzette  
 Pinces bipolaires  
 Pinzas bipolares  
 Pinze bipolari

**GRAND**  
 DEVICES  
 The Grand Instruments Company

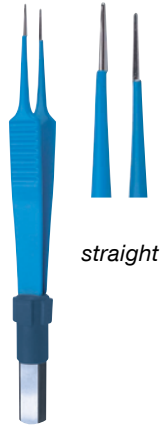

straight



angled

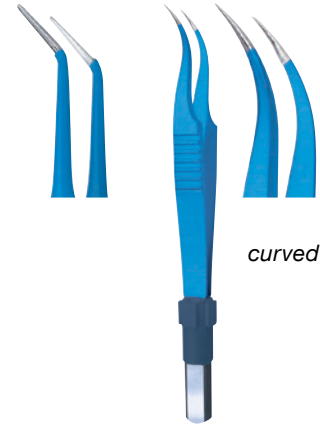

curved

Plug	Length	Width of tips	Standard	NON-STICK	Standard	NON-STICK	Standard
	11 cm	0.25 mm	<b>GD35.610.011</b>	<b>GD35.610.051</b>	<b>GD35.610.211</b>	<b>GD35.610.251</b>	<b>GD35.610.411</b>
		0.60 mm	<b>GD35.610.111</b>	<b>GD35.610.151</b>	<b>GD35.610.311</b>	<b>GD35.610.351</b>	<b>GD35.610.511</b>
		1.00 mm	-	<b>GD35.610.152</b>	-	<b>GD35.610.352</b>	-



curved shanks



Plug	Length	Width of tips	Standard
	17 cm - 6¾"	0,30 mm	<b>GD35.618-017</b>
		1,00 mm	<b>GD35.618-117</b>



Bipolar Forceps  
 Bipolare Pinzette  
 Pincas bipolaires  
 Pinzas bipolares  
 Pinze bipolari



straight



angled

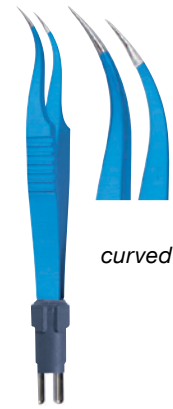

curved

Plug	Length	Width of tips	Standard	NON-STICK	Standard	NON-STICK	Standard
	12 cm – 4¾"	0,25 mm	<b>GD35.611-011</b>	<b>GD35.611-051</b>	<b>GD35.611-211</b>	<b>GD35.611-251</b>	<b>GD35.611-411</b>
		0,80 mm	<b>GD35.611-111</b>	<b>GD35.611-151</b>	<b>GD35.611-311</b>	<b>GD35.611-351</b>	<b>GD35.611-511</b>
		1,00 mm	–	<b>GD35.611-152</b>	–	<b>GD35.611-352</b>	–

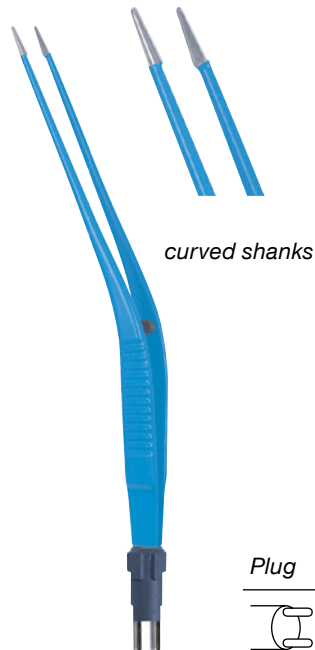

curved shanks

Plug	Length	Width of tips	Standard
	17 cm	0.30 mm	<b>GD35.619-017</b>
		1.00 mm	<b>GD35.619-117</b>



Bipolar Forceps  
 Bipolare Pinzette  
 Pinces bipolaires  
 Pinzas bipolares  
 Pinze bipolari

**GRAND**  
 DEVICES  
 The Grand Instruments Company



straight

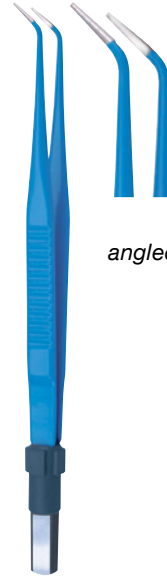

angled

Plug	Length	Width of tips	Standard	NON-STICK	Standard	NON-STICK
	15 cm	0.30 mm	<b>GD35.615.015</b>	<b>GD35.615.055</b>	<b>GD35.615.515</b>	<b>GD35.615.555</b>
		0.60 mm	–	<b>GD35.615.056</b>	–	–
		1.00 mm	<b>GD35.615.115</b>	<b>GD35.615.155</b>	<b>GD35.615.615</b>	<b>GD35.615.655</b>
		2.00 mm	–	<b>GD35.615.156</b>	–	<b>GD35.615.656</b>
	18 cm	0.30 mm	<b>GD35.615.018</b>	<b>GD35.615.058</b>	<b>GD35.615.518</b>	<b>GD35.615.558</b>
		0.60 mm	–	<b>GD35.615.059</b>	–	–
		1.00 mm	<b>GD35.615.118</b>	<b>GD35.615.158</b>	<b>GD35.615.618</b>	<b>GD35.615.658</b>
		2.00 mm	–	<b>GD35.615.159</b>	–	<b>GD35.615.659</b>
	20 cm	0.30 mm	<b>GD35.615.020</b>	<b>GD35.615.070</b>	<b>GD35.615.520</b>	–
		1.00 mm	<b>GD35.615.120</b>	<b>GD35.615.170</b>	<b>GD35.615.620</b>	–
		2.00 mm	–	<b>GD35.615.171</b>	–	–
	22 cm	0.30 mm	<b>GD35.615.022</b>	<b>GD35.615.072</b>	<b>GD35.615.522</b>	–
1.00 mm		<b>GD35.615.122</b>	<b>GD35.615.172</b>	<b>GD35.615.622</b>	–	
2.00 mm		–	<b>GD35.615.173</b>	–	–	
24 cm	0.30 mm	<b>GD35.615.024</b>	–	<b>GD35.615.524</b>	–	
	1.00 mm	<b>GD35.615.124</b>	–	<b>GD35.615.624</b>	–	

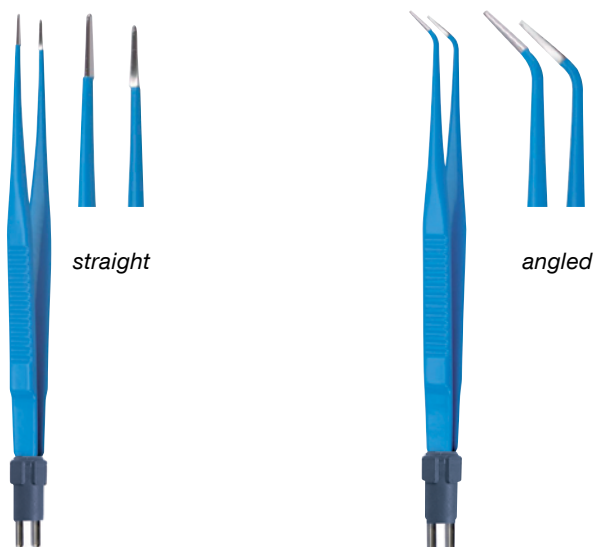

Plug	Length	Width of tips	Standard	NON-STICK	Standard	NON-STICK
	15 cm	0.30 mm	<b>GD35.616-015</b>	<b>GD35.616.055</b>	<b>GD35.616-515</b>	<b>GD35.616-555</b>
		0.60 mm	–	<b>GD35.616.056</b>	–	–
		1.00 mm	<b>GD35.616-115</b>	<b>GD35.616.155</b>	<b>GD35.616-615</b>	<b>GD35.616-655</b>
		2.00 mm	–	<b>GD35.616.156</b>	–	<b>GD35.616-656</b>
	18 cm	0.30 mm	<b>GD35.616-018</b>	<b>GD35.616.058</b>	<b>GD35.616-518</b>	<b>GD35.616-558</b>
		0.60 mm	–	<b>GD35.616.059</b>	–	–
		1.00 mm	<b>GD35.616-118</b>	<b>GD35.616.158</b>	<b>GD35.616-618</b>	<b>GD35.616-658</b>
		2.00 mm	–	<b>GD35.616.159</b>	–	<b>GD35.616-659</b>
	20 cm	0.30 mm	<b>GD35.616-020</b>	<b>GD35.616.070</b>	<b>GD35.616-520</b>	–
		1.00 mm	<b>GD35.616-120</b>	<b>GD35.616.170</b>	<b>GD35.616-620</b>	–
		2.00 mm	–	<b>GD35.616.171</b>	–	–
	22 cm	0.30 mm	<b>GD35.616-022</b>	<b>GD35.616.072</b>	<b>GD35.616-522</b>	–
		1.00 mm	<b>GD35.616-122</b>	<b>GD35.616.172</b>	<b>GD35.616-622</b>	–
		2.00 mm	–	<b>GD35.616.173</b>	–	–
	24 cm	0.30 mm	<b>GD35.616-024</b>	–	<b>GD35.616-524</b>	–
		1.00 mm	<b>GD35.616-124</b>	–	<b>GD35.616-624</b>	–



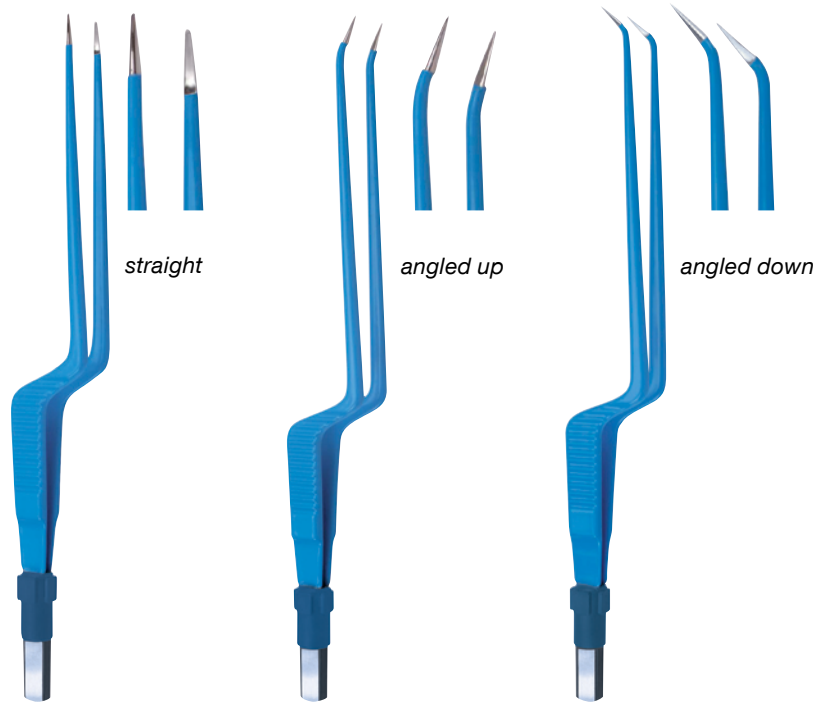

Bipolar Forceps  
 Bipolare Pinzette  
 Pincas bipolaires  
 Pinzas bipolares  
 Pinze bipolarari

**GRAND**  
 DEVICES  
 The Grand Instruments Company

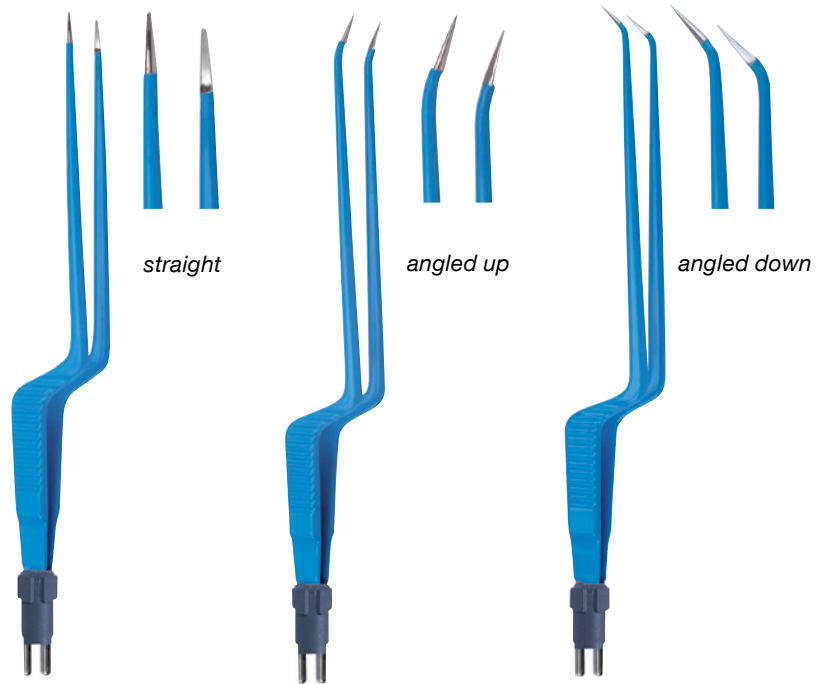

Anschluss Plug	Länge Length	Spitzenbreite Width of tips	Standard	NON-STICK	Standard	NON-STICK	Standard	NON-STICK
	16.5 cm	0.60 mm	GD35.620-017	-	-	-	-	-
	18 cm	0.30 mm	GD35.620-018	GD35.620-058	GD35.620-418	-	GD35.620-818	-
		0.60 mm	-	GD35.620-059	-	-	-	-
		1.00 mm	GD35.620-118	GD35.620-158	GD35.620-518	-	GD35.620-918	-
		2.00 mm	-	GD35.620-159	-	-	-	-
	20 cm	0.30 mm	GD35.620-020	GD35.620-070	GD35.620-420	-	GD35.620-820	-
		0.60 mm	-	GD35.620-071	-	-	-	-
		1.00 mm	GD35.620-120	GD35.620-170	GD35.620-520	HF520-570	GD35.620-920	GD35.620-970
		2.00 mm	-	GD35.620-171	-	-	-	-
	22 cm	0.30 mm	GD35.620-022	GD35.620-072	GD35.620-422	-	GD35.620-822	-
		0.60 mm	-	GD35.620-073	-	-	-	-
		1.00 mm	GD35.620-122	GD35.620-172	GD35.620-522	HF520-572	GD35.620-922	GD35.620-972
		2.00 mm	-	GD35.620-173	-	-	-	-
	24 cm	0.30 mm	GD35.620-024	GD35.620-074	GD35.620-424	-	GD35.620-824	-
		0.60 mm	-	GD35.620-075	-	-	-	-
		1.00 mm	GD35.620-124	GD35.620-174	GD35.620-524	-	GD35.620-924	-
		2.00 mm	-	GD35.620-175	-	-	-	-





Plug	Length	Width of tips	Standard	NON-STICK	Standard	NON-STICK	Standard	NON-STICK
	18 cm	0.30 mm	<b>GD35.621-018</b>	<b>GD35.621-058</b>	<b>GD35.621-418</b>	-	<b>GD35.621-818</b>	-
		0.60 mm	-	<b>GD35.621-059</b>	-	-	-	-
		1.00 mm	<b>GD35.621-118</b>	<b>GD35.621-158</b>	<b>GD35.621-518</b>	-	<b>GD35.621-918</b>	-
		2.00 mm	-	<b>GD35.621-159</b>	-	-	-	-
	20 cm	0.30 mm	<b>GD35.621-020</b>	<b>GD35.621-070</b>	<b>GD35.621-420</b>	-	<b>GD35.621-820</b>	-
		0.60 mm	-	<b>GD35.621-071</b>	-	-	-	-
		1.00 mm	<b>GD35.621-120</b>	<b>GD35.621-170</b>	<b>GD35.621-520</b>	<b>GD35.621-570</b>	<b>GD35.621-920</b>	<b>GD35.621-970</b>
		2.00 mm	-	<b>GD35.621-171</b>	-	-	-	-
	22 cm	0.30 mm	<b>GD35.621-022</b>	<b>GD35.621-072</b>	<b>GD35.621-422</b>	-	<b>GD35.621-822</b>	-
		0.60 mm	-	<b>GD35.621-073</b>	-	-	-	-
		1.00 mm	<b>GD35.621-122</b>	<b>GD35.621-172</b>	<b>GD35.621-522</b>	<b>GD35.621-572</b>	<b>GD35.621-922</b>	<b>GD35.621-972</b>
		2.00 mm	-	<b>GD35.621-173</b>	-	-	-	-
24 cm	0.30 mm	<b>GD35.621-024</b>	<b>GD35.621-074</b>	<b>GD35.621-424</b>	-	<b>GD35.621-824</b>	-	
	0.60 mm	-	<b>GD35.621-075</b>	-	-	-	-	
	1.00 mm	<b>GD35.621-124</b>	<b>GD35.621-174</b>	<b>GD35.621-524</b>	-	<b>GD35.621-924</b>	-	
	2.00 mm	-	<b>GD35.621-175</b>	-	-	-	-	

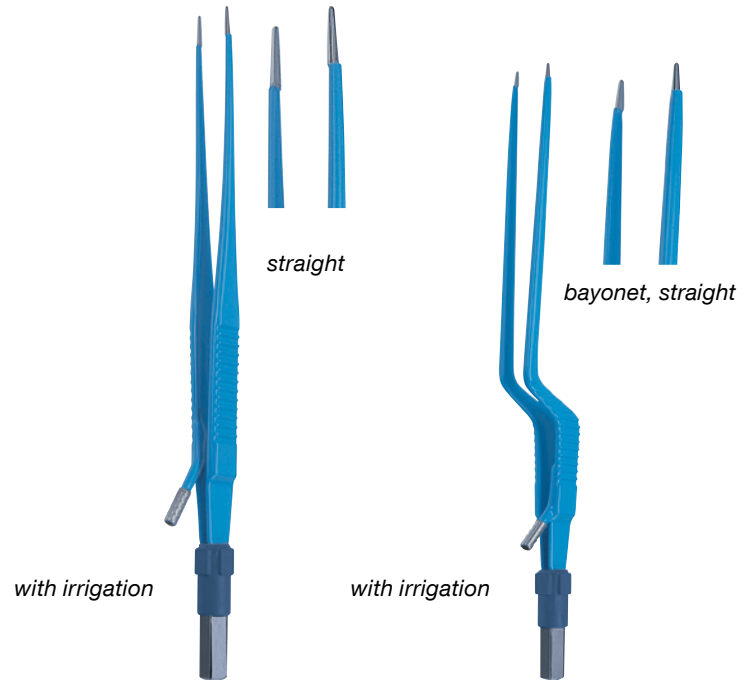

Bipolar Forceps  
 Bipolare Pinzette  
 Pinces bipolaires  
 Pinzas bipolares  
 Pinze bipolari

**GRAND**  
 DEVICES  
 The Grand Instruments Company



Plug	Length	Width of tips	Standard	Width of tips	Standard
	18cm	0.5 x 8 mm	<b>GD35.630-018</b>	0,5 x 8 mm	<b>GD35.632-018</b>
		1.0 x 8 mm	<b>GD35.630-118</b>	1,0 x 8 mm	<b>GD35.632-118</b>
		2.0 x 8 mm	<b>GD35.630-218</b>	1,5 x 8 mm	<b>GD35.632-218</b>
	20 cm	0.5 x 8 mm	<b>GD35.630-020</b>	0,5 x 8 mm	<b>GD35.632-020</b>
		1.0 x 8 mm	<b>GD35.630-120</b>	1,0 x 8 mm	<b>GD35.632-120</b>
		2.0 x 8 mm	<b>GD35.630-220</b>	1,5 x 8 mm	<b>GD35.632-220</b>
	22 cm	0.5 x 8 mm	<b>GD35.630-022</b>	0,5 x 8 mm	<b>GD35.632-022</b>
		1.0 x 8 mm	<b>GD35.630-122</b>	1,0 x 8 mm	<b>GD35.632-122</b>
		2.0 x 8 mm	<b>GD35.630-222</b>	1,5 x 8 mm	<b>GD35.632-222</b>
	24 cm	-	-	0,5 x 8 mm	<b>GD35.632-024</b>
		-	-	1,0 x 8 mm	<b>GD35.632-124</b>
		-	-	1,5 x 8 mm	<b>GD35.632-224</b>

Bipolar Forceps  
 Bipolare Pinzette  
 Pinces bipolaires  
 Pinzas bipolares  
 Pinze bipolari

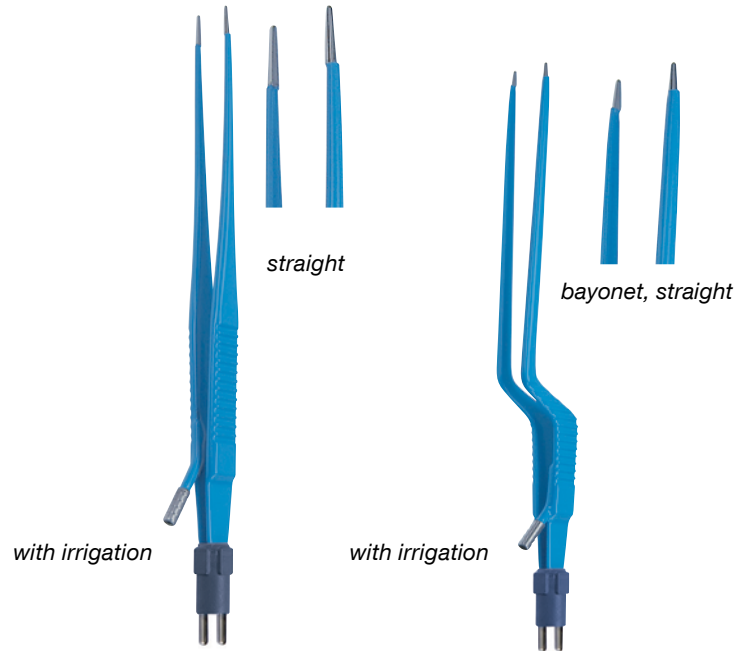

Plug	Length	Width of tips	Standard	Width of tips	Standard
	18 cm	0.5 x 8 mm	<b>GD35.631-018</b>	0.5 x 8 mm	<b>GD35.633-018</b>
		1.0 x 8 mm	<b>GD35.631-118</b>	1.0 x 8 mm	<b>GD35.633-118</b>
		2.0 x 8 mm	<b>GD35.631-218</b>	1.5 x 8 mm	<b>GD35.633-218</b>
	20 cm	0.5 x 8 mm	<b>GD35.631-020</b>	0.5 x 8 mm	<b>GD35.633-020</b>
		1.0 x 8 mm	<b>GD35.631-120</b>	1.0 x 8 mm	<b>GD35.633-120</b>
		2.0 x 8 mm	<b>GD35.631-220</b>	1.5 x 8 mm	<b>GD35.633-220</b>
	22 cm	0.5 x 8 mm	<b>GD35.631-022</b>	0.5 x 8 mm	<b>GD35.633-022</b>
		1.0 x 8 mm	<b>GD35.631-122</b>	1.0 x 8 mm	<b>GD35.633-122</b>
		2.0 x 8 mm	<b>GD35.631-222</b>	1.5 x 8 mm	<b>GD35.633-222</b>
	24 cm	-	-	0.5 x 8 mm	<b>GD35.633-024</b>
		-	-	1.0 x 8 mm	<b>GD35.633-124</b>
		-	-	1.5 x 8 mm	<b>GD35.633-224</b>



Bipolar Forceps  
 Bipolare Pinzette  
 Pincés bipolaires  
 Pinzas bipolares  
 Pinze bipolari

**GRAND**  
 DEVICES  
 The Grand Instruments Company



**TC**  
 Tungsten  
 Carbide

**General information** Features  
 of our bipolar forceps,  
 insulated, with **TC** insert:

Safe grasping  
 Virtually no tissue sticking  
 Excellent vessel closure

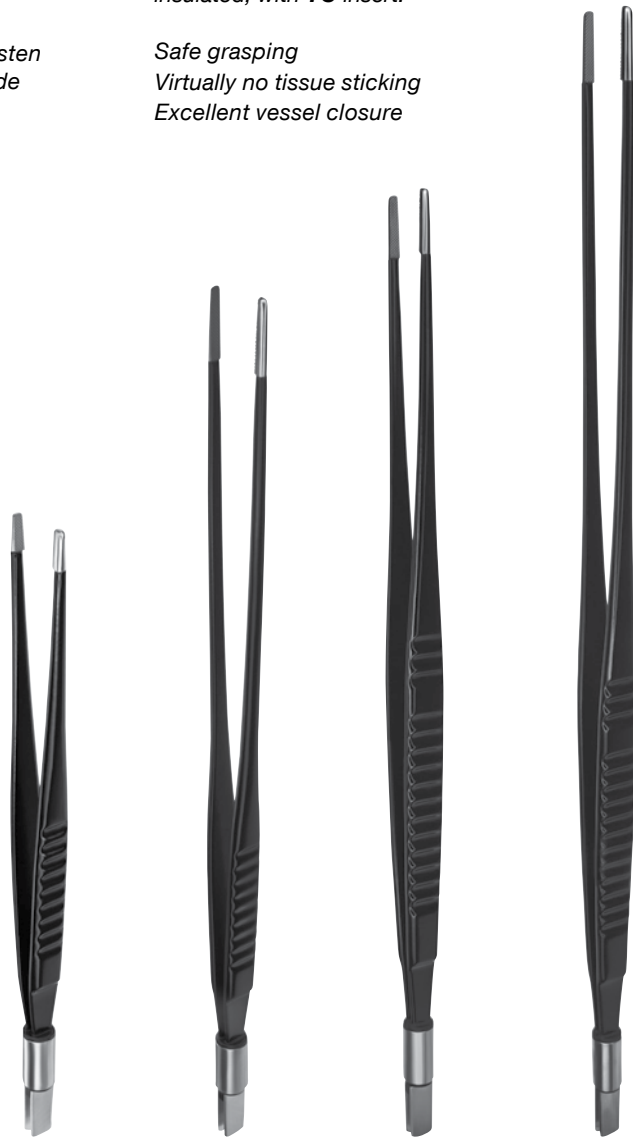

<i>Plug</i>	<i>Width of tips</i>	16.5 cm	22 cm	25 cm	30 cm
	2.2 mm	<b>GD35.5302-46</b>	<b>GD35.5302-52</b>	<b>GD35.5302-55</b>	<b>GD35.5302-57</b>





**TC**  
 Tungsten  
 Carbide

**General information** Features  
 of our bipolar forceps,  
 insulated, with **TC** insert:

Safe grasping  
 Virtually no tissue sticking



Plug	Width of tips	19 cm	19 cm
	2.2 mm	<b>GD35.5302-76</b>	<b>GD35.5302-82</b>



Bipolar Clamps  
Bipolare Klemmen  
Pinces bipolaires  
Abrazaderas bipolares  
Morsetti bipolari

**GRAND**  
DEVICES  
*The Grand Instruments Company*



GD35.6100.18



GD35.6110.18

**Bipolar, Mono polar Laparoscopic Forceps**  
**Bipolare, monopolare laparoskopische Pinzette**  
**Pinces laparoscopiques bipolaires et monopolaires**  
**Pinzas laparoscópicas bipolares y monopolares**  
**Pinze laparoscopiche bipolari e monopolari**



**GD35.6220.10**

Laparoscopic forceps  
Grasping, vessel sealing bipolar forcep

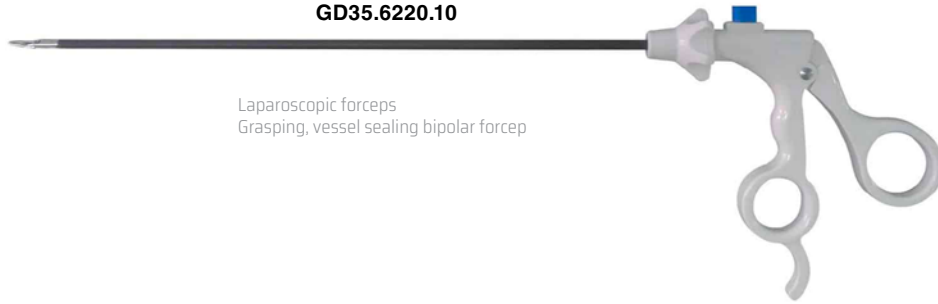

**GD35.6221.10**

Laparoscopic Bipolar Coagulation  
Forceps, Reusable Bipolar Forceps For  
Abdominal Surgery, Find Complete  
Details about Laparoscopic Bipolar  
Coagulation

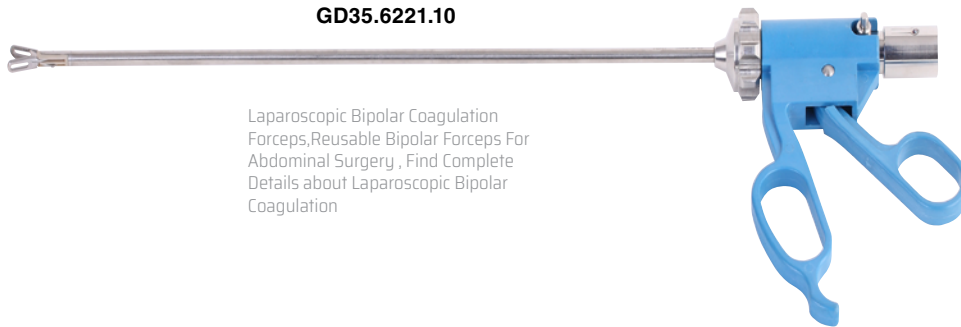

**GD35.6222.10**

Laparoscopic forceps Unimicro Medical  
Systems dissection mono polar

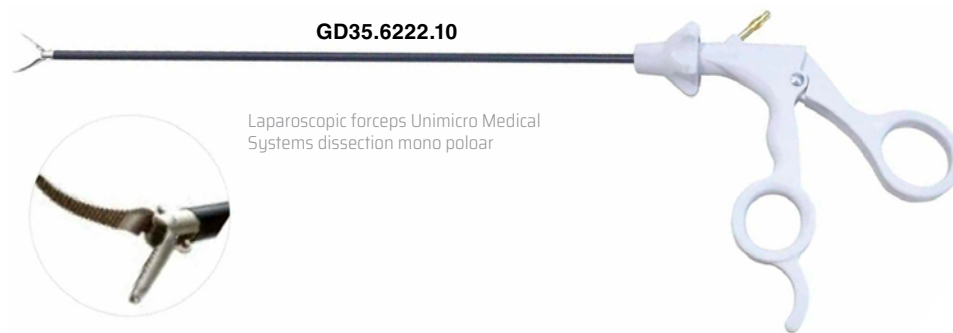

**GD35.6223.10**

Reusable Laparoscopy Surgical Bipolar  
Forceps

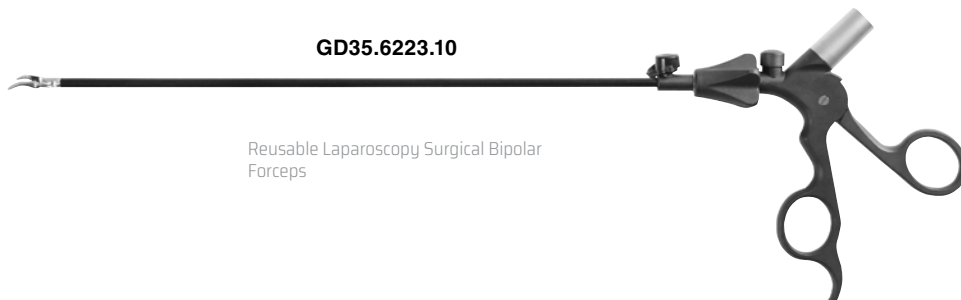



Vaginal Specula  
Vaginalspekula  
Speculums vaginaux  
Espéculos vaginales  
Specoli vaginali

**GRAND**  
DEVICES  
*The Grand Instruments Company*



**GD35.6224.75**  
**GD35.6224.85**  
**GD35.6224.100**  
**GD35.6224.150**

Cusco Speculum Blue Insulated with  
Smoke Tube and Gold Plated Screw  
75 x 32 = Small  
85 x 35 = Medium  
100 x 35 = Large  
150 x 37 = X-Large



**GD35.6225.100**  
Vaginal Speculum

Vaginal Retractors  
Scheidenhalter  
Velves vaginales  
Valvas vaginales  
Valve vaginali



**GD35.6226.24**

LLETZ Lateral Vaginal Wall Retractor  
9.5"/24cm



**GD35.6227.10**

Vaginal Retractor for laser & electro  
surgery



Bipolar Connecting Cables  
 Bipolare Verbindungskabel  
 Câbles de connexion bipolaires  
 Cables de conexión bipolares  
 Cavi di collegamento bipolari

**GRAND**  
 DEVICES  
 The Grand Instruments Company



For bipolar forceps

Flat plug



2-pin plug US-Standard



Plug, generator side	Length		Length	
 Valleylab, Birtcher, Conmed, Bovie	3 m	<b>GD35.410-103</b>	4 m	<b>GD35.410-3031</b>
	5 m	<b>GD35.410-105</b>	-	-
 Erbe ACC / ICC, Storz	3 m	<b>GD35.410-113</b>	3 m	<b>GD35.410-313</b>
	5 m	<b>GD35.410-115</b>	5 m	<b>GD35.410-315</b>
 Martin, Berchtold, Aesculap	3 m	<b>GD35.410-123</b>	3 m	<b>GD35.410-323</b>
	5 m	<b>GD35.410-125</b>	5 m	<b>GD35.410-325</b>
 Valleylab, Lamidey, EMC	3 m	<b>GD35.410-133</b>	3 m	<b>GD35.410-333</b>
	5 m	<b>GD35.410-135</b>	5 m	<b>GD35.410-335</b>

Obstetrics  
Geburtshilfe  
Obstétrique  
Obstetricia  
Ostetricia  
产科

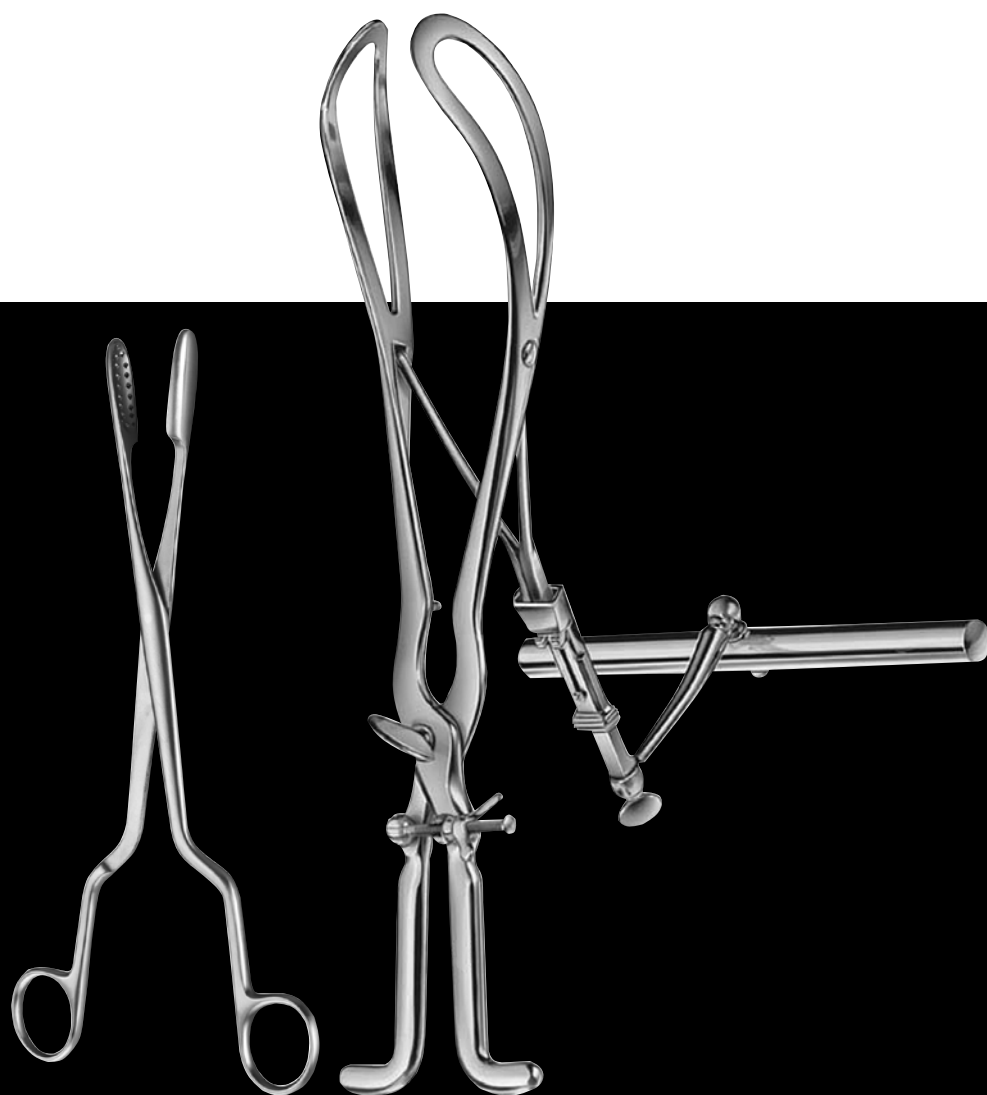

**GD36**



Obstetrical Forceps  
Geburtszangen  
Forceps obstétriques  
Fórceps obstétricos  
Forcipi obstetrici

**GRAND**  
DEVICES  
The Grand Instruments Company

Forceps for caesarean section  
Geburtszangen für section caesares (Schnittentbindung)  
Forceps pour césarienne  
Fórceps para operación cesárea  
Forcipi per tagli cesarei



WRIGLEY

23.0 cm **GD36.101.23**  
28.0 cm **GD36.101.28**



SIMPSON

30.0 cm **GD36.102.30**



SIMPSON

23.0 cm **GD36.103.23**



SIMPSON-BRAUN

33.0 cm **GD36.105.33**  
36.0 cm **GD36.105.36**



De LEE

30.0 cm **GD36.107.30**



De LEE

36.0 cm **GD36.108.36**  
39.0 cm **GD36.108.39**



KIELLAND

41.0 cm **GD36.110.41**



ELLIOT

32.0 cm **GD36.115.32**  
38.0 cm **GD36.115.38**





**NAEGELE**

36.0 cm **GD36.119.36**  
40.0 cm **GD36.119.40**



**LUIKART**

40.0 cm **GD36.125.40**



**KIELLAND-LUIKART**

40.0 cm **GD36.127.40**



**SIMPSON-LUIKART**

36.0 cm **GD36.135.36**

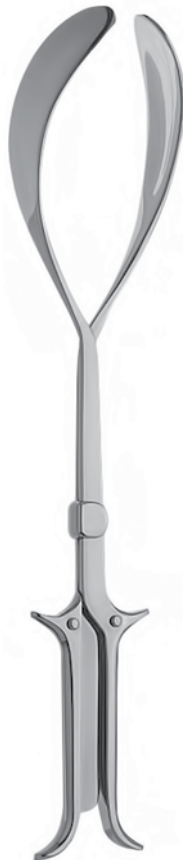

**McLEAN-TUCKER-LUIKART**

40.0 cm **GD36.139.40**



**McLEAN-TUCKER**

39.0 cm **GD36.141.39**



**McLEAN-LUIKART**

39.0 cm **GD36.143.39**



Obstetrical Forceps  
Geburtszangen  
Forceps obstétriques  
Fórceps obstétricos  
Forcipi obstetrici

**GRAND**  
DEVICES  
The Grand Instruments Company



**McLEAN**  
36.0 cm **GD36.145.36**



**BARTON**  
36.0 cm **GD36.147.36**



**BARTON**  
17.0 cm **GD36.148.17**



**BOERMA**  
29.0 cm **GD36.151.29**



**PIPER**  
44.0 cm **GD36.155.44**

for delivery of the after coming head in breech presentation  
für nachkommenden Kopf bei Steisslagen  
patules pour dégager la tête  
Especialmente para partos en presentación de nalgas  
Speciale in parti con predentazione di podice



**PIPER**  
40.0 cm **GD36.157.40**

Obstetrical Forceps  
Geburtszangen  
Forceps obstétriques  
Fórceps obstétricos  
Forcipi obstetrici



**DEWEY**

37.0 cm **GD36.160.37**



Forceps with traction rod  
Geburtszange mit Achsenzugvorrichtung  
Forceps avec dispositif de traction  
Fórceps con dispositivo de tracción  
Forcipi con dispositivo di trazione

**TARNIER**

40.0 cm **GD36.162.40**

Head extractor for use in lower segment in caesarean operation  
Kopfhobel für unteres Segment bei Kaiserschnitt  
Levier à tête utilisé en cas de césarienne  
Elevador para cabeza usándose en le segmento inferior del útero  
en casos de operaciones cesáreas  
Elevatore per testa in interventi con taglio cesareo

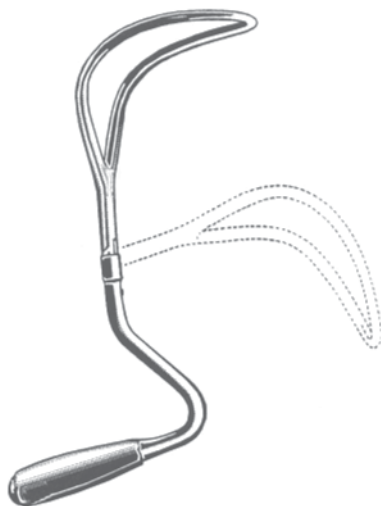

**MURLESS**

**GD36.164.26**



**BILL**

**GD36.170.00**

Traction handle to be used with all forceps with standard type handle  
Zughebel, passend für alle Geburtszangen mit gehorntem Standard-Griff  
Tracteurs pour tous les forceps avec manches ordinaires  
Tractor adecuado para todas las fórceps con mango standard  
Manico a trazione adatto a tutte le forcipi con manico standard



**LUIKART-BILL**

21.0 cm **GD36.171.21**



Obstetrics  
Geburtshilfe  
Accouchements  
Obstetricia  
Ostetricia

**GRAND**  
DEVICES  
*The Grand Instruments Company*



**SMELLIE**

33.0 cm **GD36.181.33**

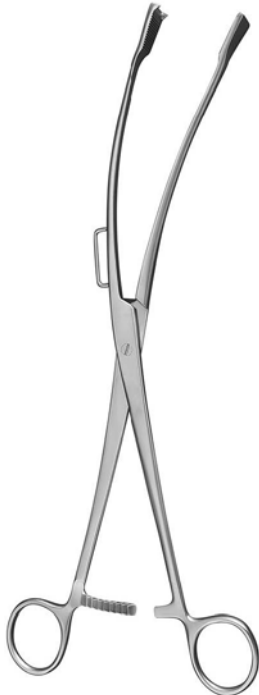

**GAUSS**

27.0 cm **GD36.183.27**

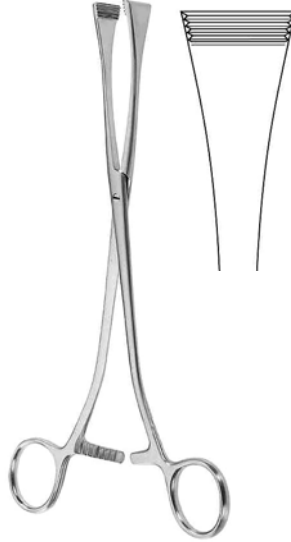

**GREEN-ARMYTAGE**

21.0 cm **GD36.184.21**

Caesarean section haemostatic forceps  
Uterusklemmzange zur Blutstillung  
Pince-clamp utérine pour hémostase  
Pinza-clamp uterina para hemostasis  
Pinza emostatiche per tagli cesarei

Umbilical Cord Clamps  
Nabelschnurklemmen  
Clamps p. cordon ombilical  
Clamps umbilicales  
Pinze ombelicali



**COLLIN**

9.0 cm **GD36.187.09**



**KANE**

8.5 cm **GD36.189.09**



**MARTIN**

34.0 cm **GD36.191.34**



**COLLIER**

30.0 cm **GD36.193.30**



**COLLIN**

35.0 cm **GD36.195.35**

Placenta and Ovum Forceps  
 Plazentar- und Abortuszangen  
 Pinces placentaires et pour poste-abortum  
 Pinzas para aborto y placenta  
 Pinze per placenta e per ovaie

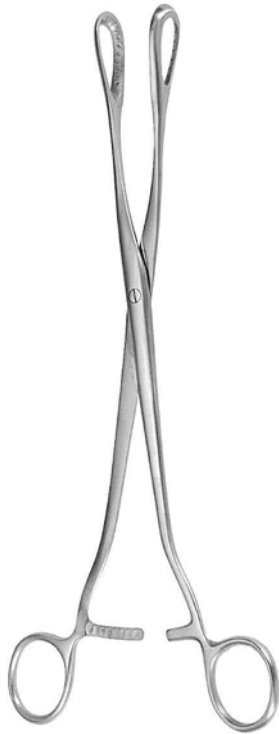

**SAENGER**  
 GD36.242.27

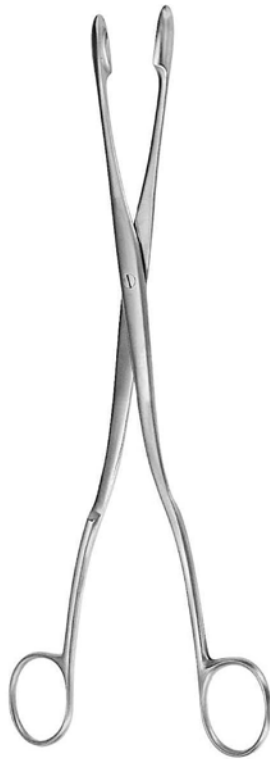

**WINTER 28.0 cm**  
 GD36.244.01 Fig. 1  
 GD36.244.02 Fig. 2  
 GD36.244.03 Fig. 3



**WINTER**  
 Fig. 2 GD36.247.02  
 Fig. 3 GD36.247.03



**LEWKOWITZ**  
 GD36.248.24



**McLINTOCK**  
 24.0 cm GD36.250.24



Placenta and ovum scoops  
Plazentar- und Abortuslöffel  
Curettes à avortement et placenta  
Cucharillas para aborto y placenta  
Cucchiai per placenta e ovaie

**GRAND**  
DEVICES  
*The Grand Instruments Company*



**PESTALLOZZA**

30.0 cm **GD36.252.30**



**CUZZI**

30.0 cm **GD36.254.14 - GD36.254.21**



**GD36.254.14** **GD36.254.18** **GD36.254.21**  
14.5 mm 18.0 mm 21.0 mm

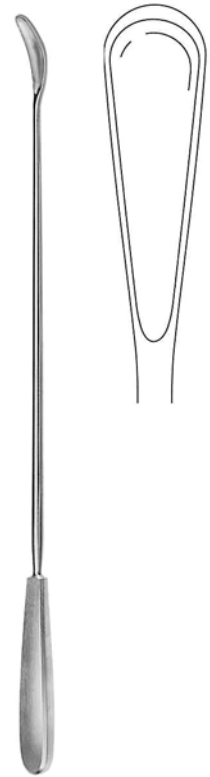

**WALLICH**

42.0 cm **GD36.256.42**



**SELLHEIM**

28.0 cm **GD36.259.28**



**BRAUN**

42.0 cm **GD36.302.42**



**TARNIER**

46.0 cm **GD36.304.46**



**SMELLIE**

25.0 cm **GD36.306.25**

Perforator  
Perforatorium  
Perce-crâne  
Perfora-crâneos  
Spezzacrânio



**NÄGELE**

25.0 cm **GD36.308.25**



**BRAUN**

30.0 cm **GD36.309.30**

Decapitating hook  
Dekapitationshaken  
Grochet pour décapitation  
Gancho para decapitación  
Uncino per detroncazione





Dermatology, Hygiene  
Dermatologie, Hygiene  
Dermatologie, Hygiène  
Dermatología, Higiene  
Dermatologia, Igiene  
皮肤卫生



**GD37**



Dermatology  
Dermatologie  
Dermatologie  
Dermatología  
Dermatologia

**GRAND**  
DEVICES  
The Grand Instruments Company



**KILNER**

15.0 cm **GD37.103.15**



**SCHAMBERG**

10.0 cm **GD37.111.10**



**UNNA**

14.0 cm **GD37.113.14**



**UNNA**

14.0 cm **GD37.115.14**



**WALTON**

14.0 cm **GD37.118.14**



**SAALFELD**

10.0 cm **GD37.121.10**

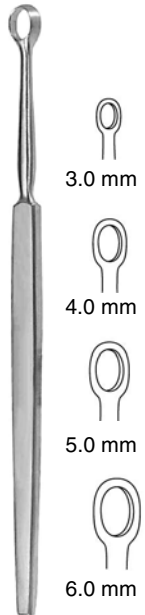

**FOX**

3.0 mm **GD37.128.03**  
4.0 mm **GD37.128.04**  
5.0 mm **GD37.128.05**  
6.0 mm **GD37.128.06**



**PIFFARD**

Fig. 1 **GD37.130.01**  
Fig. 2 **GD37.130.02**  
Fig. 3 **GD37.130.03**



Fig. 1



Fig. 2



Fig. 3



**KEYES**

compl. **GD37.138.00**



**KEYES**

○ 2.0 mm  
○ 3.0 mm  
○ 4.0 mm  
○ 5.0 mm  
○ 6.0 mm  
○ 7.0 mm  
○ 8.0 mm  
1/1  
2.0 mm **GD37.140.02**  
3.0 mm **GD37.140.03**  
4.0 mm **GD37.140.04**  
5.0 mm **GD37.140.05**  
6.0 mm **GD37.140.06**  
7.0 mm **GD37.140.07**  
8.0 mm **GD37.140.08**



GD37.301.10



GD37.304.10 10.0 cm GD37.305.10



14.0 cm GD37.331.14



14.0 cm GD37.336.14



**TURNBULL**  
11.5 cm GD37.341.11  
13.5 cm GD37.341.13



13.0 cm GD37.360.13



11.0 cm GD37.365.11



10.0 cm GD37.373.10



10.0 cm GD37.378.10



10.0 cm GD37.379.10

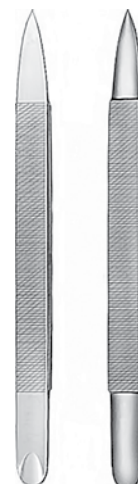

10.0 cm GD37.386.10  
12.0 cm GD37.386.12



**CREDO**  
14.5 cm GD37.395.14



**GD37.396.00**  
10 Spare Blades  
10 Ersatzklingen  
10 lames de rechange  
10 hojas de repuesto  
10 lame di ricambio



Different Containers  
Verschiedene Behälter  
Boîtes diverses  
Contenedores varios  
vassoi diversi  
不同的容器



**GD38**



**Needle Cases**  
**Nadeldosen**  
**Boites pour aiguilles**  
**Estuches para agujas**  
**Scatole per aghi**

18/10  
Stainless Steel  
Edelstahl rostfrei  
Acier inoxydable  
Acero inoxidable  
Acciaio inossidabile

Complete with perforated interior box  
komplett mit perforierter Innendose  
complet avec boite interieure perforée  
completo con caja interior perforada  
completo con scatola interiore perforata



65 x 15 mm **GD38.112.65**

**GRAND**  
DEVICES  
*The Grand Instruments Company*

Interior Box  
Perforated lid and bottom  
Innendose  
Deckel und Boden perforiert  
Boite intérieure  
couverture et fond perforé  
Caja interior  
tapa y fondo perforado  
Scatola interiore  
coperchio e fondo perforati



**GD38.113.65**

**Needle Cases**  
**Nadelkassetten**  
**Boites pour aiguilles**  
**Estuches para agujas**  
**Scatole per aghi**

Perforated lid and bottom  
Deckel und Boden perforiert  
couverture et fond perforé  
tapa y fondo perforado  
coperchio e fondo perforati



**SAUERBRUCH**

210x125x17 mm **GD38.110.21**

Perforated lid and bottom  
Deckel und Boden perforiert  
couverture et fond perforé  
tapa y fondo perforado  
coperchio e fondo perforati



150x95x13 mm **GD38.114.00**

Different Containers  
 Verschiedene Behälter  
 Boîtes diverses  
 Contenedores varios  
 Vassoi diversi



lid without knob  
 Deckel ohne Knopf  
 couvercle sans bouton  
 tapa sin botón  
 coperchio senza bottone



Instrumentenkästen  
 Instrument Boxes  
 Boîtes pour instruments  
 Cajas para instrumentos  
 Scatole per strumenti

**L x B x H**

165 x 85 x 35 mm **GD38.120.16**  
 200 x 100 x 60 mm **GD38.120.20**  
 220 x 120 x 60 mm **GD38.120.22**  
 230 x 130 x 50 mm **GD38.120.23**  
 260 x 150 x 50 mm **GD38.120.26**  
 280 x 140 x 60 mm **GD38.120.30**  
 500 x 200 x 120 mm **GD38.120.50**  
 180 x 180 x 40 mm **GD38.120.18**  
 250 x 120 x 60 mm **GD38.120.25**  
 320 x 150 x 60 mm **GD38.120.32**  
 400 x 160 x 75 mm **GD38.120.40**

lid with knob  
 mit Knopfdeckel  
 avec couvercle à bouton  
 tapa con botón  
 con coperchio a bottone



Instrument Boxes  
 Instrumentenkästen  
 Boîtes pour instruments  
 Cajas para instrumentos  
 Scatole per strumenti

**L x B x H**

320 x 100 x 50 mm **GD38.123.32**  
 430 x 100 x 35 mm **GD38.123.43**

lid with knob  
 mit Knopfdeckel  
 avec couvercle à bouton  
 tapa con botón  
 con coperchio a bottone



Instrument Boxes  
 Instrumentenkästen  
 Boîtes pour instruments  
 Cajas para instrumentos  
 Scatole per strumenti

**L x B x H**

170 x 120 x 60 mm **GD38.124.17**  
 200 x 60 x 35 mm **GD38.124.20**  
 220 x 100 x 50 mm **GD38.124.22**  
 220 x 140 x 60 mm **GD38.124.23**  
 270 x 170 x 60 mm **GD38.124.27**  
 300 x 180 x 65 mm **GD38.124.30**



Different Containers  
Verschiedene Behälter  
Boîtes diverses  
Contenedores varios  
Vassoi diversi

**GRAND**  
DEVICES  
The Grand Instruments Company



Cotton dispensers  
Wattspender  
Distributeurs de coton  
Dispensores de algodón  
Distributore del cotone

**Ø x H**

75x	60 mm	<b>GD38.127.10</b>
75x	75 mm	<b>GD38.127.11</b>
100 x	60 mm	<b>GD38.127.20</b>
100 x	100 mm	<b>GD38.127.21</b>
125 x	80 mm	<b>GD38.127.30</b>
125 x	125 mm	<b>GD38.127.31</b>
150 x	150 mm	<b>GD38.127.40</b>



Stainless Steel Bowls  
Metallschalen  
Cuvettes de acier inoxydable  
Cubetas de acero inoxidable  
Scodelle di acciaio inossidabile

**Ø x H**

40 x 19 mm	0.05 Liter	<b>GD38.130.04</b>
61 x 30 mm	0.07 Liter	<b>GD38.130.06</b>
80 x 40 mm	0.14 Liter	<b>GD38.130.08</b>
116 x 50 mm	0.35 Liter	<b>GD38.130.12</b>
128 x 55 mm	0.45 Liter	<b>GD38.130.13</b>
147 x 65 mm	0.70 Liter	<b>GD38.130.15</b>
157 x 75 mm	1.10 Liter	<b>GD38.130.16</b>
187 x 85 mm	1.60 Liter	<b>GD38.130.19</b>



Stainless Steel Bowls  
Metallschalen  
Cuvettes de acier inoxydable  
Cubetas de acero inoxidable  
Scodelle di acciaio inossidabile

**Ø x H**

42 x	30 mm	<b>GD38.131.01</b>
53 x	34 mm	<b>GD38.131.02</b>
58 x	40 mm	<b>GD38.131.03</b>
64 x	48 mm	<b>GD38.131.04</b>
68 x	47 mm	<b>GD38.131.05</b>
71 x	46 mm	<b>GD38.131.06</b>
71 x	50 mm	<b>GD38.131.07</b>
81 x	51 mm	<b>GD38.131.08</b>
81 x	54 mm	<b>GD38.131.09</b>
89 x	47 mm	<b>GD38.131.10</b>
100 x	48 mm	<b>GD38.131.11</b>
100 x	53 mm	<b>GD38.131.12</b>



Different Containers  
 Verschiedene Behälter  
 Boîtes diverses  
 Contenedores varios  
 Vassoi diversi



Wash Bowls  
 Waschschüsseln  
 Cuvettes  
 Palanganas  
 Scodelle per liquidi

Ø x H

300 x 100 mm	<b>GD38.132.01</b>
350 x 100 mm	<b>GD38.132.02</b>
400 x 100 mm	<b>GD38.132.03</b>
330 x 90 mm	<b>GD38.132.04</b>
330 x 115 mm	<b>GD38.132.05</b>



Round Bowls  
 Runde Schüsseln  
 Cuvettes rondes  
 Cubetas redondas  
 Scodelle rotonde

Ø x H

150 x 74 mm	0.75 Liter	<b>GD38.133.16</b>
160 x 65 mm	1.00 Liter	<b>GD38.133.17</b>
220 x 70 mm	2.00 Liter	<b>GD38.133.22</b>
230 x 80 mm	2.50 Liter	<b>GD38.133.23</b>
260 x 130 mm	4.50 Liter	<b>GD38.133.24</b>
255 x 115 mm	3.50 Liter	<b>GD38.133.25</b>
275 x 115 mm	5.00 Liter	<b>GD38.133.27</b>
300 x 105 mm	6.00 Liter	<b>GD38.133.29</b>
400 x 150 mm	14.00 Liter	<b>GD38.133.38</b>



Solution Bowls  
 Spülschale  
 Cuvettes rondes  
 Cubetas redondas  
 Scodelle rotonde

Ø x H

300 x 120 mm	<b>GD38.133.31</b>
350 x 130 mm	<b>GD38.133.34</b>
400 x 140 mm	<b>GD38.133.41</b>



Irrigator  
 Irrigatoren  
 Irrigateurs  
 Irrigadores  
 Irrigatori

1.00 Liter	<b>GD38.134.10</b>
1.50 Liter	<b>GD38.134.15</b>
2.00 Liter	<b>GD38.134.20</b>



Different Containers  
Verschiedene Behälter  
Boîtes diverses  
Contenedores varios  
Vassoi diversi

**GRAND**  
DEVICES  
The Grand Instruments Company



Bed pan (american pattern)  
Stechbecken, amerik. Form  
Bassin de lit (modèle américain)  
Silletas (forma americana)  
Padelle (modello americano)

**L x B x H**

380 x 230 x 95 mm **GD38.136.23**

350 x 270 x 100 mm **GD38.136.27**



Bed pan  
Stechbecken  
Bassin de lit  
Silletas  
Padelle

**Ø**

235 mm

**GD38.137.23**

310 mm

**GD38.137.30**



Bed pan  
Stechbecken  
Bassin de lit  
Silletas  
Padelle

**L x B x H**

300 x 200 x 75 mm Small (with handle)

**GD38.137.40**

300 x 200 x 75 mm Small (with out handle)

**GD38.137.41**

350 x 230 x 100 mm Large (with handle)

**GD38.137.43**



Sputum Cup  
Sputumbecher  
Crachoir  
Escupideria  
Sputacchiera

**Ø x H**

100 x 50 mm

**GD38.138.70**

Different Containers  
Verschiedene Behälter  
Boîtes diverses  
Contenedores varios  
Vassoi diversi



Kidney bowls  
Nierenschalen  
Bassins réniformes  
Riñoneras  
Padelle reniformi

**L x B x H**

170 x 100 x 30 mm	<b>GD38.139.17</b>
200 x 120 x 35 mm	<b>GD38.139.20</b>
250 x 140 x 40 mm	<b>GD38.139.25</b>
275 x 150 x 50 mm	<b>GD38.139.27</b>
300 x 160 x 50 mm	<b>GD38.139.30</b>
400 x 200 x 60 mm	<b>GD38.139.40</b>



Funnels  
Trichter  
Entonnoires  
Embudos  
Imbuti

**Ø x H**

100 x 100 mm	<b>GD38.139.91</b>
150 x 150 mm	<b>GD38.139.92</b>



Medicine Cups  
Medizinbecher  
Gobelets  
Vasos graduados  
Bicchieri per medicinali

**Ø x H**

58 x 30 mm	25ml	<b>GD38.140.00</b>
52 x 50 mm	50ml	<b>GD38.140.01</b>
65 x 55 mm	100ml	<b>GD38.140.03</b>



Measuring jugs  
Meßbecher  
Gobelets gradués  
Copas graduadas  
Misurino

0.25 Liter	<b>GD38.140.02</b>
0.50 Liter	<b>GD38.140.05</b>
1.00 Liter	<b>GD38.140.10</b>
2.00 Liter	<b>GD38.140.20</b>



Different Containers  
Verschiedene Behälter  
Boîtes diverses  
Contenedores varios  
Vassoi diversi

**GRAND**  
DEVICES  
*The Grand Instruments Company*



Petri Dishes  
Petrischalen  
Boîtes de Petri  
Cápsulas de Petri  
Scodella di Petri

Ø x H

60 x 20 mm	<b>GD38.141.06</b>
90 x 15 mm	<b>GD38.141.09</b>
100 x 20 mm	<b>GD38.141.10</b>
120 x 20 mm	<b>GD38.141.12</b>



Metal Jars  
Standgefäße  
Récipients en métal  
Tarros metálicos  
Recipienti metallici

Ø x H

30 x 90 mm	<b>GD38.142.01</b>
50 x 100 mm	<b>GD38.142.02</b>
50 x 130 mm	<b>GD38.142.03</b>
50 x 175 mm	<b>GD38.142.04</b>
75 x 100 mm	<b>GD38.142.05</b>
75 x 130 mm	<b>GD38.142.06</b>
75 x 175 mm	<b>GD38.142.07</b>
100 x 175 mm	<b>GD38.142.08</b>
100 x 200 mm	<b>GD38.142.09</b>



Instrument Trays  
Instrumententablets  
Plateaux pour instruments  
Bandejas para instrumentos  
Bacinelle per strumenti

L x B x H

190 x 100 x 13 mm	<b>GD38.142.19</b>
200 x 100 x 13 mm	<b>GD38.142.20</b>



Instrument Trays  
Instrumententablets  
Plateaux pour instruments  
Bandejas para instrumentos  
Bacinelle per strumenti

L x B x H

190 x 100 x 13 mm	<b>GD38.143.19</b>
200 x 100 x 13 mm	<b>GD38.143.20</b>
450 x 300 x 32 mm	<b>GD38.143.45</b>

Different Containers  
 Verschiedene Behälter  
 Boîtes diverses  
 Contenedores varios  
 Vassoi diversi



Instrument Trays  
 Instrumententabletts  
 Plateaux pour instruments  
 Bandejas para instrumentos  
 Bacinelle per strumenti

**L x B x H**

200 x 150 x 25 mm	<b>GD38.144.20</b>
230 x 155 x 30 mm	<b>GD38.144.22</b>
300 x 175 x 30 mm	<b>GD38.144.28</b>
300 x 175 x 40 mm	<b>GD38.144.31</b>
300 x 200 x 50 mm	<b>GD38.144.32</b>
350 x 220 x 40 mm	<b>GD38.144.35</b>
400 x 300 x 50 mm	<b>GD38.144.37</b>
450 x 350 x 50 mm	<b>GD38.144.42</b>

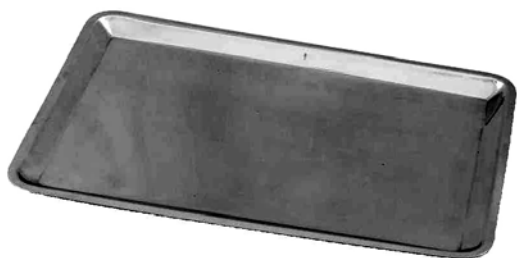

Instrument Trays  
 Instrumententabletts  
 Plateaux pour instruments  
 Bandejas para instrumentos  
 Bacinelle per strumenti

**L x B x H**

210 x 160 x 10 mm	<b>GD38.145.21</b>
240 x 180 x 10 mm	<b>GD38.145.24</b>
290 x 190 x 10 mm	<b>GD38.145.29</b>
310 x 150 x 10 mm	<b>GD38.145.30</b>
300 x 200 x 20 mm	<b>GD38.145.32</b>
300 x 245 x 16 mm	<b>GD38.145.33</b>
350 x 240 x 10 mm	<b>GD38.145.35</b>
385 x 265 x 16 mm	<b>GD38.145.38</b>
385 x 210 x 10 mm	<b>GD38.145.39</b>
400 x 270 x 20 mm	<b>GD38.145.40</b>
420 x 280 x 10 mm	<b>GD38.145.42</b>
430 x 295 x 16 mm	<b>GD38.145.43</b>
485 x 320 x 16 mm	<b>GD38.145.49</b>
510 x 380 x 30 mm	<b>GD38.145.51</b>
590 x 380 x 30 mm	<b>GD38.145.59</b>



Universal Trays  
 Mehrzweckschalen  
 Plateaux universaux  
 Bandejas universales  
 Bacinelle universali

**L x B x H**

220 x 170 x 50 mm	<b>GD38.146.22</b>
300 x 175 x 30 mm	<b>GD38.146.28</b>
300 x 175 x 40 mm	<b>GD38.146.30</b>
300 x 200 x 50 mm	<b>GD38.146.32</b>
350 x 240 x 36 mm	<b>GD38.146.35</b>
400 x 300 x 50 mm	<b>GD38.146.37</b>
450 x 350 x 50 mm	<b>GD38.146.42</b>



Different Containers  
Verschiedene Behälter  
Boîtes diverses  
Contenedores varios  
Vassoi diversi

**GRAND**  
DEVICES  
*The Grand Instruments Company*



Urinal male  
Urinal für Männer  
Urinal homme  
Urinal hombre  
Urinale uomo

**L x B x H**

230 x 150 x 85 mm **GD38.147.31**



Urinal female  
Urinal für Frauen  
Urinal femme  
Urinal mujer  
Urinale donna

**L x B x H**

230 x 150 x 85 mm **GD38.147.32**



Urinal  
Urinal  
Urinal  
Urinal  
Urinale

**Ø x H**

230 x 115 mm **GD38.147.33**



Cups  
Becher  
Réipients  
Tarros  
Recipienti

**Ø x H**

75 x 75 mm	0.25 Liter	<b>GD38.150.02</b>
100 x 85 mm	0.50 Liter	<b>GD38.150.05</b>
115 x 100 mm	0.75 Liter	<b>GD38.150.07</b>
125 x 125 mm	1.00 Liter	<b>GD38.150.10</b>



Waste Bucket  
Abfalleimer  
Seaux pour déchets  
Cobo para desechos  
Secchi per rifiuti

10.00 Liter  
15.00 Liter

**GD38.754.10**  
**GD38.754.15**



**Sterilizing Drums**  
**Sterilisiertrommeln**  
**Tambours à stérilisation**  
**Tambores p. esterilización**  
**Tambori p. sterilizzazione**



18/10  
 Stainless Steel  
 Edelstahl rostfrei  
 Acier inoxydable  
 Acero inoxidable  
 Acciaio inossidabile



SCHIMMELBUSCH	Lx B x H	KONRICH
GD38.152.08	125x 80 mm	GD38.182.08
GD38.152.10	125x100 mm	GD38.182.10
GD38.152.12	125x125 mm	GD38.182.12
GD38.155.08	150x 80 mm	
GD38.155.10	150x100 mm	GD38.185.10
GD38.155.13	150x130 mm	GD38.185.13
GD38.155.15	150x150 mm	GD38.185.15
GD38.155.19	150x190 mm	GD38.185.19
GD38.159.14	190x145 mm	GD38.189.14
GD38.159.16	190x165 mm	GD38.189.16
GD38.159.19	190x190 mm	GD38.189.19
GD38.159.24	190x240 mm	GD38.189.24
GD38.164.14	240x145 mm	
GD38.164.16	240x165 mm	GD38.194.16
GD38.164.19	240x190 mm	GD38.194.19
GD38.164.24	240x240 mm	GD38.194.24
GD38.164.29	240x290 mm	GD38.194.29
GD38.164.34	240x340 mm	
GD38.164.39	240x390 mm	
GD38.169.14	290x145 mm	GD38.199.14
GD38.169.16	290x165 mm	GD38.199.16
GD38.169.19	290x190 mm	GD38.199.19
GD38.169.24	290x240 mm	GD38.199.24
GD38.169.29	290x290 mm	GD38.199.29
GD38.169.34	290x340 mm	
GD38.169.39	290x390 mm	
GD38.174.14	340x145 mm	GD38.204.14
GD38.174.16	340x165 mm	GD38.204.16
GD38.174.19	340x190 mm	GD38.204.19
GD38.174.24	340x240 mm	GD38.204.24
GD38.174.29	340x290 mm	GD38.204.29
GD38.174.34	340x340 mm	
GD38.174.39	340x390 mm	
GD38.1GD38.14	390x145 mm	GD38.209.14
GD38.1GD38.16	390x165 mm	GD38.209.16
GD38.1GD38.19	390x190 mm	GD38.209.19
GD38.1GD38.24	390x240 mm	GD38.209.24
GD38.1GD38.29	390x290 mm	GD38.209.29
GD38.1GD38.34	390x340 mm	GD38.209.34
GD38.1GD38.39	390x390 mm	GD38.209.39
GD38.1GD38.49	390x490 mm	
GD38.1GD38.59	390x590 mm	





18/10  
Stainless Steel  
Edelstahl rostfrei  
Acier inoxydable  
Acero inoxidable  
Acciaio inossidabile

Wire Mesh  
Aus Drahtgeflecht  
En fil inox  
De alambre  
In rete metallica

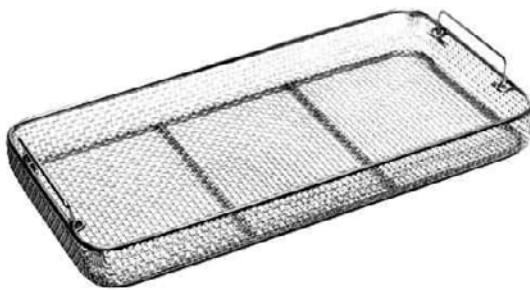

**L x B x H**

240 x 250 x 5 mm **GD38.240.24**  
480 x 250 x 5 mm **GD38.240.48**  
550 x 250 x 5 mm **GD38.240.55**  
240 x 250 x 7 mm **GD38.241.24**  
480 x 250 x 7 mm **GD38.241.48**  
240 x 250 x 10 mm **GD38.242.24**  
480 x 250 x 10 mm **GD38.242.48**

From Perforated Sheet Metal  
Aus perforiertem Blech  
En tôle perforée  
De chapa de acero perforada  
In acciaio perforato



**L x B x H**

260 x 260 x 5 mm **GD38.250.26**  
480 x 260 x 5 mm **GD38.250.48**





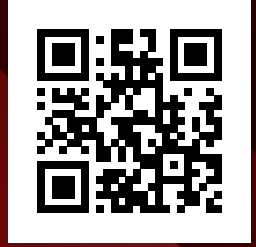

## Grand Devices

Maharaja Manzil,  
Maharaja Road,  
Sialkot-51310-Pakistan.

Tel: +92 52 4580776-7  
Email: [info@grand.com.pk](mailto:info@grand.com.pk)

